

Freewing M^oDEL

Freewing 80mm EDF JET

F9F-8 Cougar User Manual

Wingspan: 1050mm

Length: 1436mm

Empty Weight: 2420G[w/o Battery]

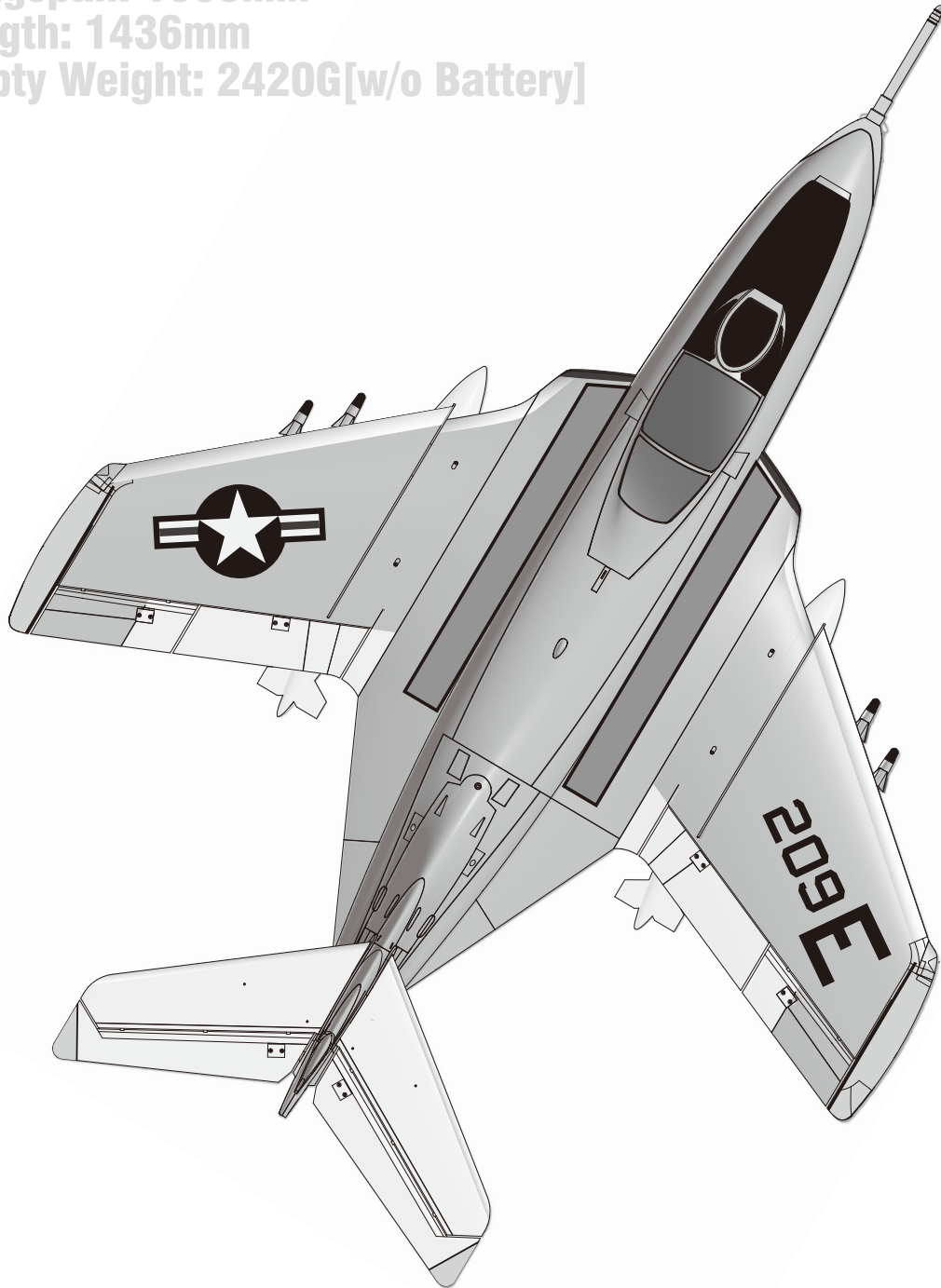

EN	1~11
中	12~22

- 1 Introduction
- 2 Product basic information
- 2 Package list
- PNP Assembly instructions
- 3 Install horizontal stabilizer
- 4 Install vertical stabilizer
- 5 Install main wing
- 6 Install drop tank、missiles
- 6 Install small plastic parts
- 7 Install battery
- 7 Pushrod instructions
- 7 Important additional notes
- 8 Center of gravity
- PNP Parameter setting
- 9 Control direction test
- 10 Dual rates
- Pre-installed component overview
- 11 Servo direction
- 11 Motor specification

- 12 前言
- 13 产品规格参数
- 13 包装列表
- PNP组装步骤介绍
- 14 平尾组装
- 15 垂尾组装
- 16 主翼组装
- 17 副油箱、导弹组装
- 17 其它配件组装
- 18 电池介绍
- 18 舵面控制钢丝尺寸及安装孔位
- 18 重要附加说明
- 19 重心示意图
- PNP调试介绍
- 20 模型舵面测试
- 21 舵量范围
- 预装电子配件介绍
- 22 舵机介绍
- 22 电机介绍

Thank you for purchasing our Freewing 80mm EDF super scale jet, the F9F-8 Cougar! Before you assemble this F9F-8 model jet, please carefully read the instructions and follow the correct process for assembly and adjustment. If you encounter problems during assembly and debugging, please first resolve them by referring to the instructions. If the problem persists, please contact the distributor or directly contact us.

The F9F-8 Cougar is a swept-wing fighter jet re-developed by the Grumman Company of the United States based on the F9F Panther "Panther" in 1953. This Freewing 1/10 scale F9F-8 Cougar 80mm EDF electric model jet uses EPO material and uses the plastic structure, cabin door and other details. Horizontal tail and Vertical tail uses the screws to fix, main wing uses the newest Freewing assemble structure---quick portable install. No glue or screws to fix, and easy to carry. The Freewing F9F-8 Cougar PNP version includes a preinstalled 80mm EDF power system at 2023, comprising a 12-blade EDF impeller, 3658-2150KV in-runner motor, 100A ESC with reverse thrust function. The new power system provides more powerful thrust, resulting in a top speed of 180 kph/112.5 mph for this aircraft.

The Freewing F9F-8 EDF jet uses the main gray paint of the US Navy VF-61 Squadron, with partial yellow and silver patterns, making it also highly recognizable in the sky. This jet has low requirements for flight technology, and is a medium-sized scale basic training jet. The PNP version is pre-installed with a gyro at factory, which can also maintain a stable flight attitude at low speeds in 2-3 wind speeds. The new shock absorbing structure of the landing gear makes the reciprocating motion of the shock absorbing rod more flexible, and the shock absorbing effect is better. The outer diameter of the front and rear wheels of 45mm/50mm enables the aircraft to take off and land on grass.

Thank you again! I hope this product can bring you more beautiful flight time!

⚠ NOTE: This is not a toy. Not for children under 14 years. Young people under the age of 14 should only be permitted to operate this model under the instruction and supervision of an adult. Please keep these instructions for further reference after completing model assembly.

Note:

- 1.This is not a toy! Operater should have a certain experience, beginners should operate under the guidance of professional players.
- 2.Before install, please read through the instructions carefully and operate strictly under instructions.
- 3.Cause of wrong operation,Freewing and its vendors will not be held responsible for any losses.
- 4.Model planes' players must be on the age of 14 years old.
- 5.This plane used the EPO material with surface spray paint, don' t use chemical to clean, otherwise it will damage.
- 6.You should be careful to avoid flying in areas such as public places,high-voltage-intensive areas,near the highway, near the airport or any other place where laws and regulation clearly prohibit.
- 7.You cannot fly in bad weather conditions such as thunderstorms,snows....
- 8.Model plane's battery, don't allowed to put in everywhere. Storage must ensure that there is no inflammable and explosive materials in the round of 2M range.
- 9.Damaged or scrap battery should be properly recycled, it can't discard to avoid spontaneous combustion and fire.
- 10.In flying field, the waste after flying should be properly handled,it can't be abandoned or burned.
- 11.In any case, you must ensure that the throttle is in the low position and transmitter switch on, then it can connect the lipo-battery in aircraft.
- 12.Do not try to take planes by hand when flying or slow landing process. You must wait for landing stop, then carry it.

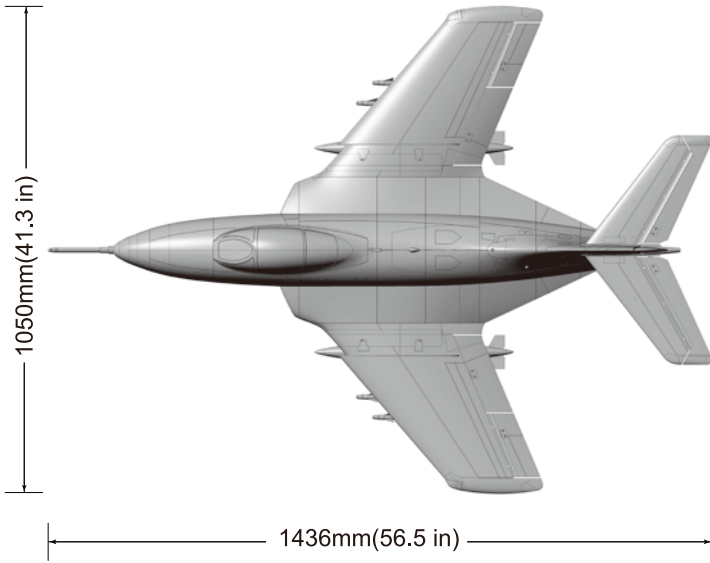

Standard Version

Wingload: 120 g/dm²
 Wing Area: 26.5 dm²
 Servo: 9g Hybrid digital servo (10pcs)
 Motor: 3658-2150KV I/R Motor
 ESC: 100A with 7A UBEC
 (Thrust Reverse Function)
 Gyro: pre-installed and pre-set
 Ducted fan: 80mm 12-blade fan
 Weight: 2420g (w/o Battery)

Other features

Material: EPO
 Aileron: Yes Elevator: Yes
 Flaps: Yes Rudder: Yes
 Landing gear: Electric landing gear
 Cabin door: Yes
 Li-Po Battery: 6S 4000-5200mAh

⚠ Note: The parameters in here are derived from test result using our accessories. If use other accessories, the test result will be different. Any problem since of using other accessories, we are not able to provide technical support.

Package List

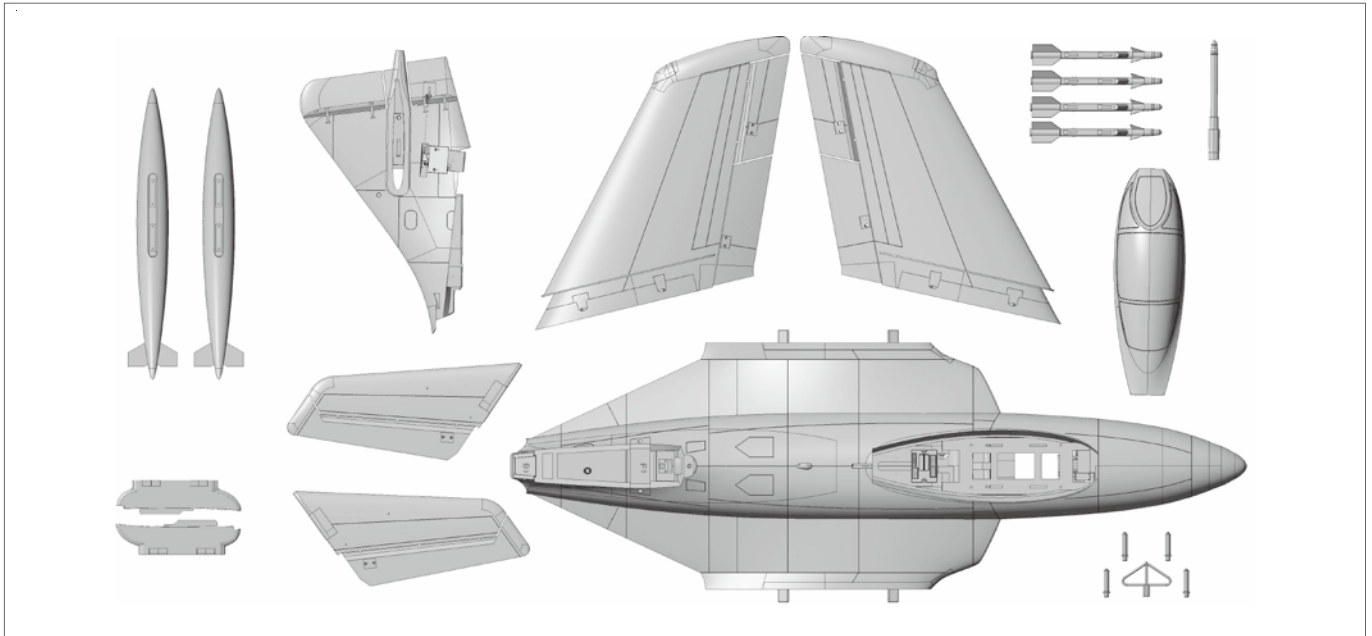

Different equipment include different spareparts. Please refer to the following contents to check your sparepart list.

No.	Name	PNP	ARF Plus
1	Fuselage	Pre-installed all electronic parts	Pre-installed servo
2	Main wing	Pre-installed all electronic parts	Pre-installed servo
3	Horizontal tail	Pre-installed all electronic parts	Pre-installed servo
4	Vertical tail	Pre-installed all electronic parts	Pre-installed servo
5	Missiles	✓	✓

No.	Name	PNP	ARF Plus
6	Drop tanks & pylons	✓	✓
7	Pushrod	✓	✓
8	Screw bag	✓	✓
9	Manual	✓	✓

Install Horizontal Stabilizer

As the photo show:

- 1.Insert the carbon tube into the vertical tail;
- 2.Insert one side horizontal tail into the vertical tail,
Use the traction metal wire to pull out the servo cable
along the vertical tail slot;
- 3.After installed the horizontal tail, fix it with screw;
- 4.Repeat the above steps to install the other side
of horizontal tail.

Screw (KA3X10mm 2pcs)
Carbon tube (Ø4x210mm)

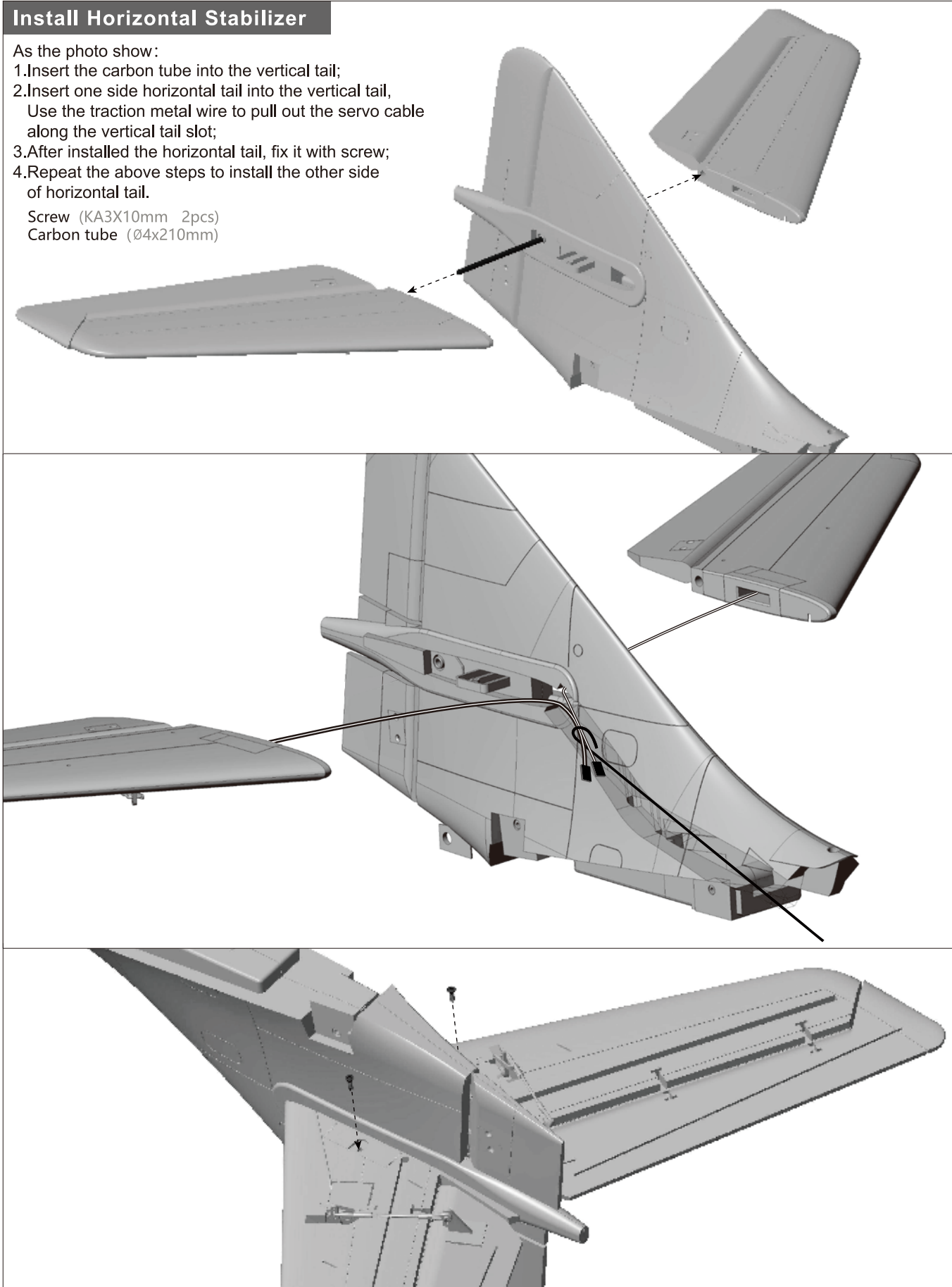

Install Vertical Stabilizer

As the photo show:

- 1.As shown in the photo, after installed the tail set, insert the rudder servo cable and the elevator servo cable into the PCB board at the rear fuselage, the elevator servo cable into the ELE interface, and the rudder servo cable into the RUD interface;
- 2.Fix the tail set with screws.

Screw (KA3X10mm 5pcs)

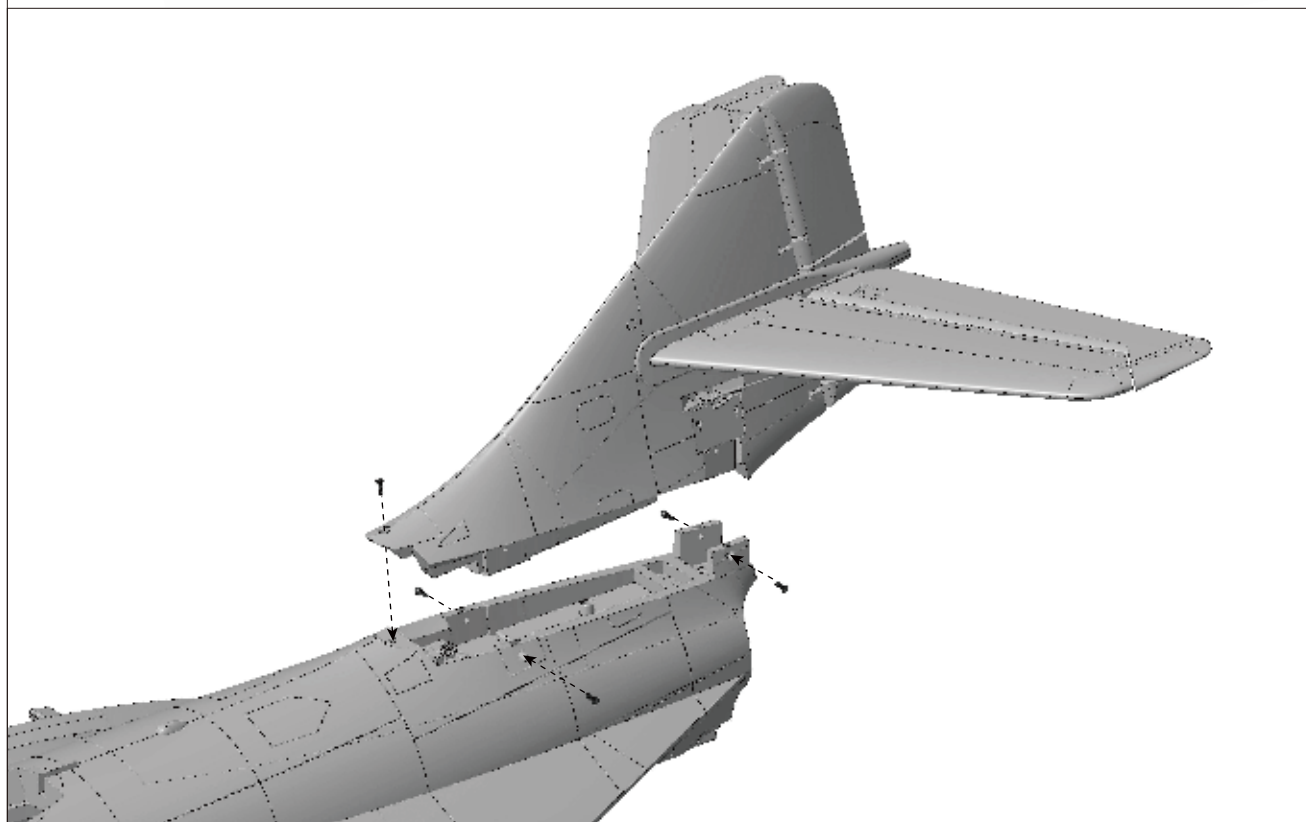
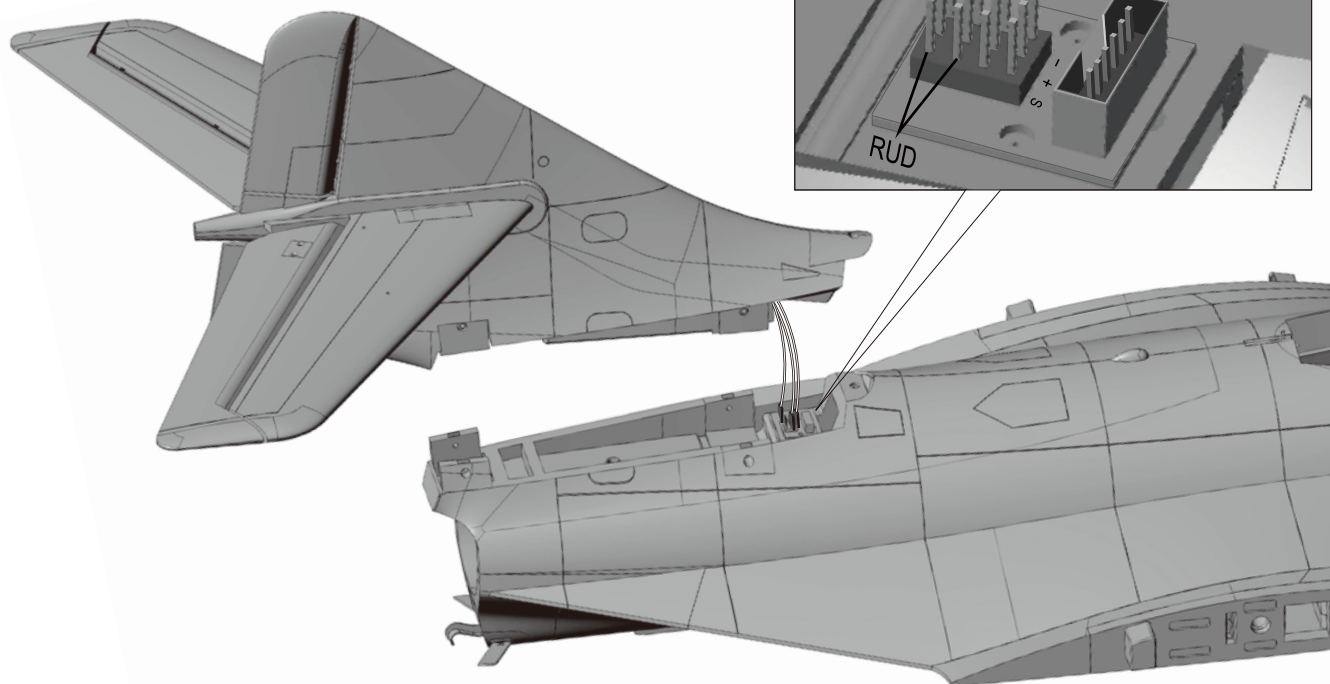

Install Main Wing

As the photo show:

1. Insert the main wing carbon fiber tube after aligning with point A of the fuselage. Before closing, connect the ribbon wire into the main wing board interface;
2. After the main wing side slot is aligned with the fuselage point B, C, continue to close the main wing and the fuselage;
3. When a slight "click" sound is heard, it is proved that the main wing has been installed;
4. Check to confirm that the latch toggle lever on the wing upper surface of main wing has been reset and locked ❶;
5. Repeat the above steps to install the main wing on the other side.

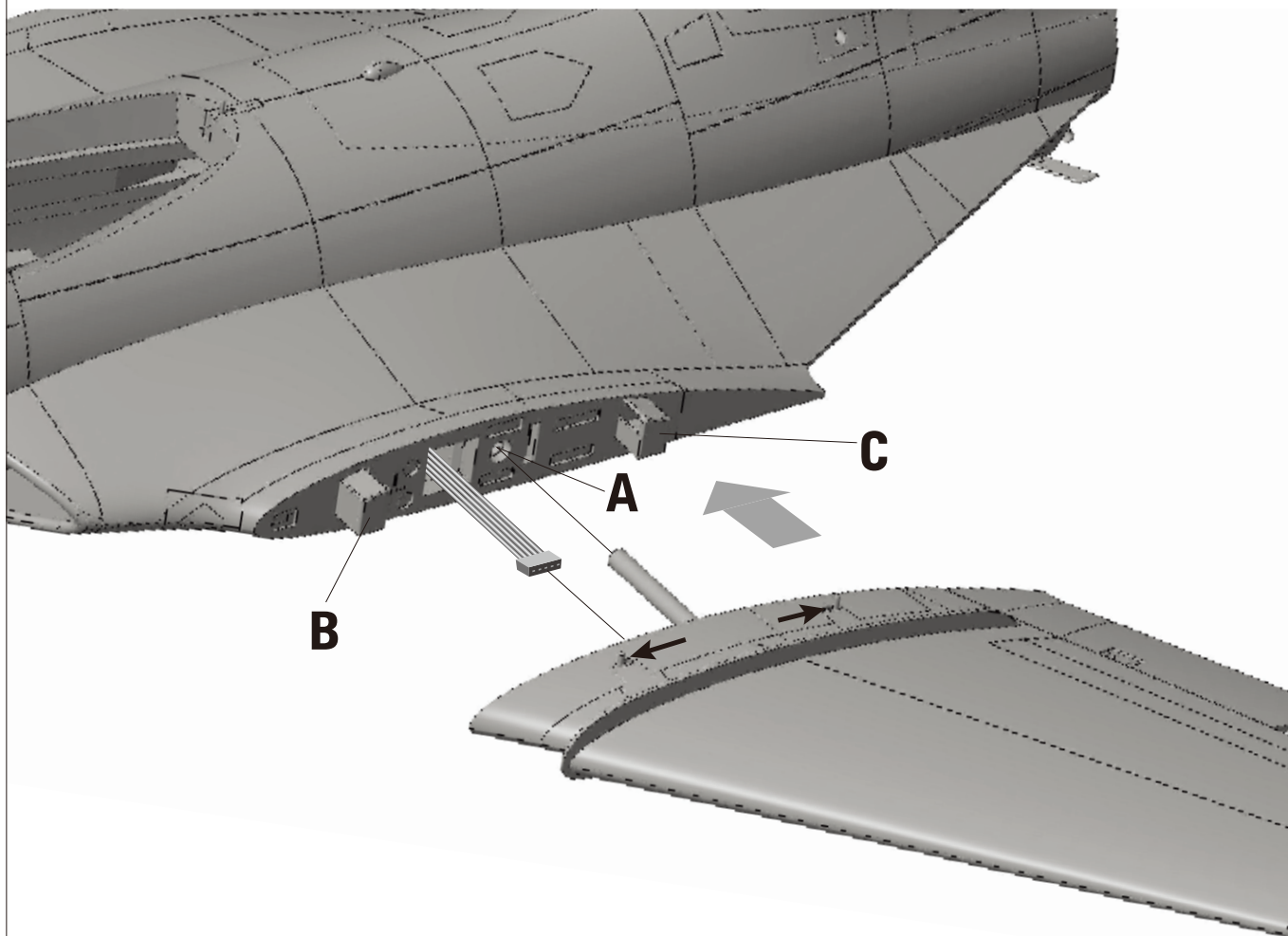

❶ Three different states of the latch toggle lever is as the photo shown:

Latch toggle lever lock status

As the photo show, the front/rear lever is in outside end point

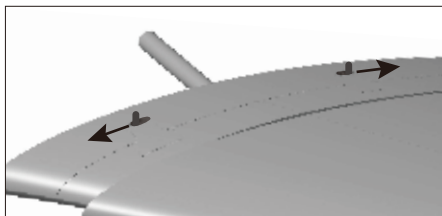

When unlocking, it is necessary to manually push the front and rear toggle levers towards the middle at the same time.

Latch toggle lever unlock status

As the photo show, the front/rear lever is in inside end point

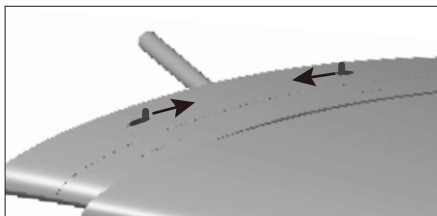

The latch toggle lever abnormal status

As the photo show, the front/rear lever is not in outside or inside end points

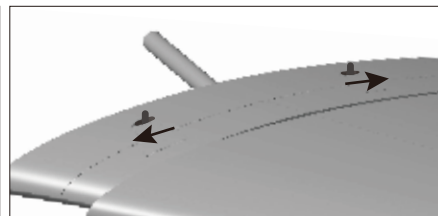

After installed the main wing, please check carefully. If happen the abnormal status, it is necessary to manually push the latch toggle lever to reset.

Install Drop Tank, Missiles

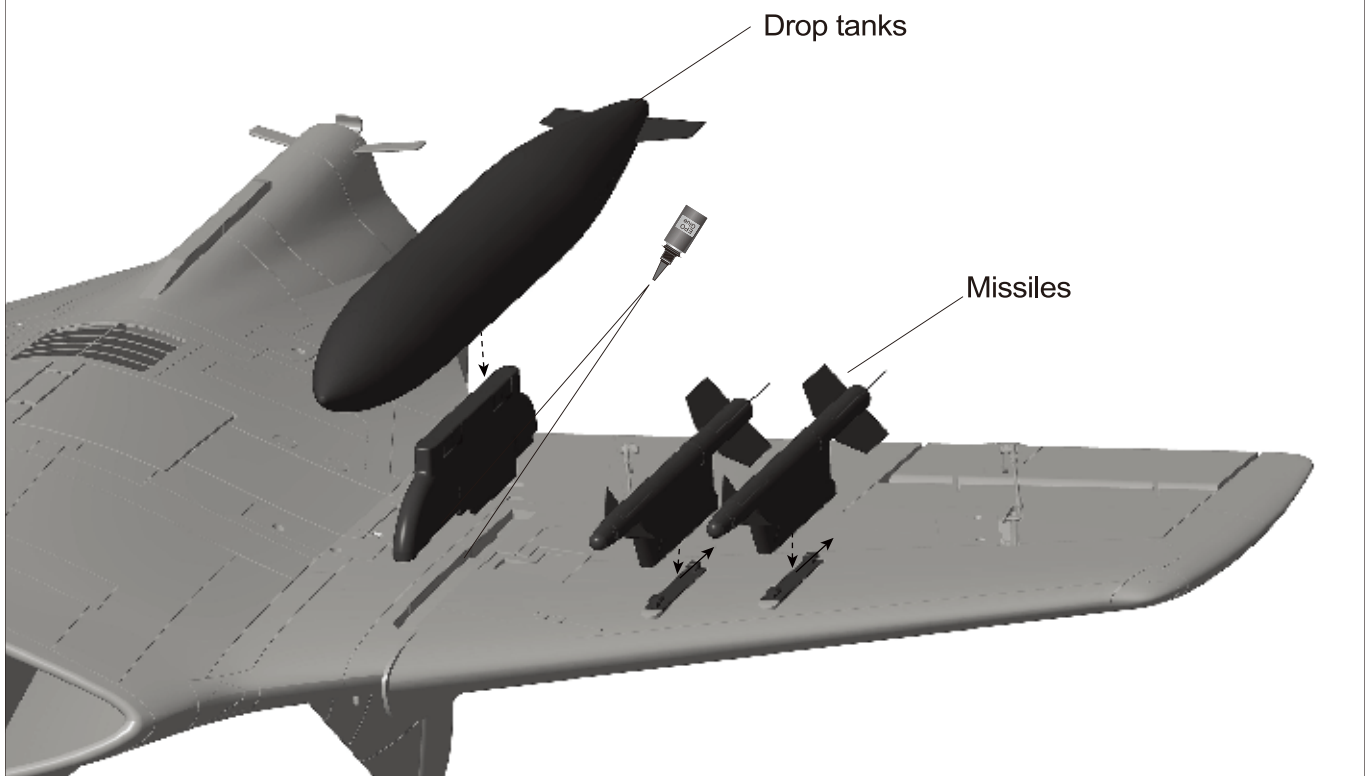

Install Small Plastic Parts

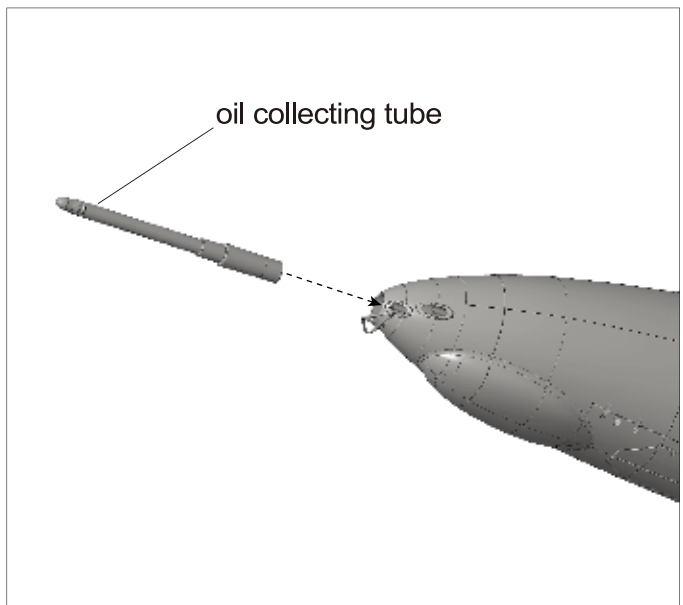
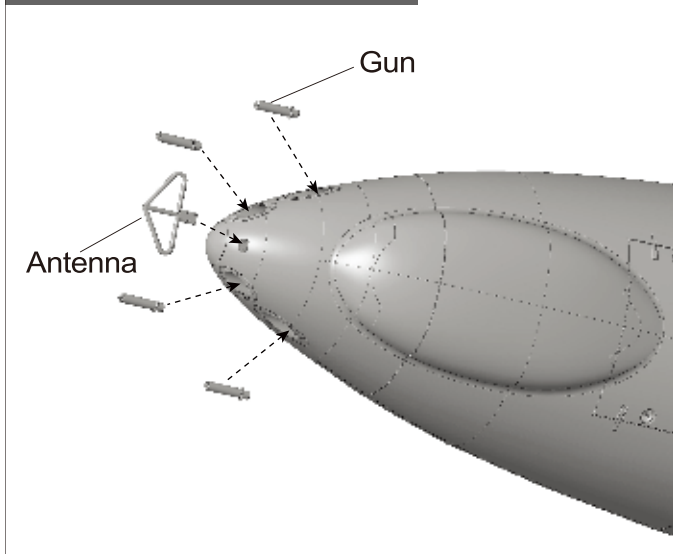

Install Battery

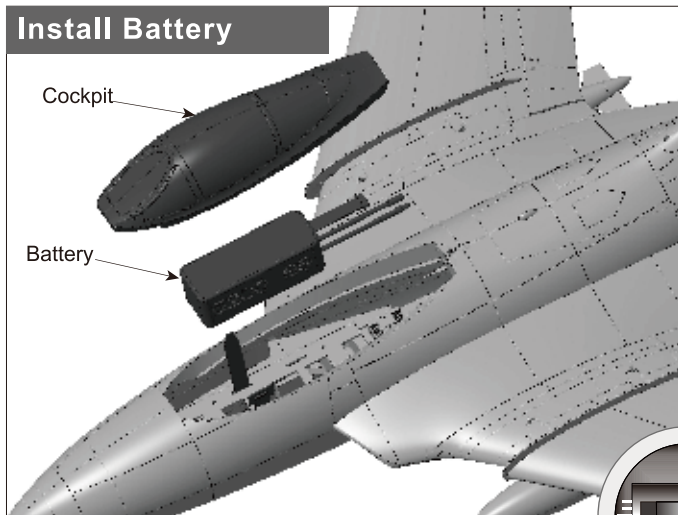

Battery size: 6S 4000~5200mAh
Battery weight :750g

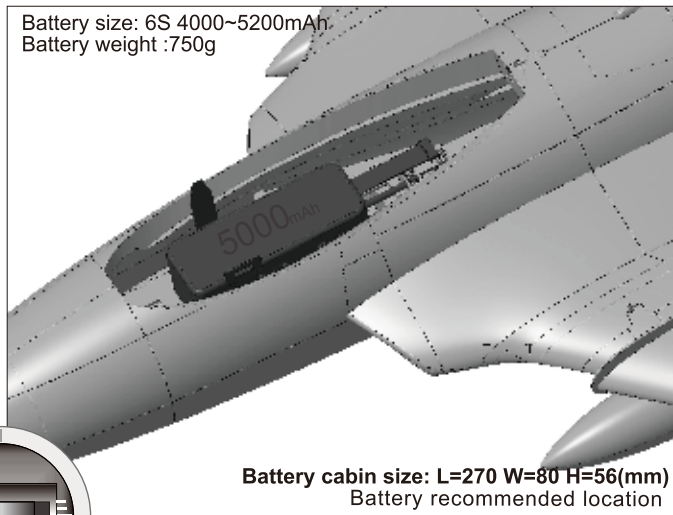

Battery cabin size: L=270 W=80 H=56(mm)
Battery recommended location

Before connecting the battery and receiver, please switch on the transmitter power and make sure the throttle stick is in the lowest position. Bind your receiver to your transmitter according to your transmitter's instruction manual.

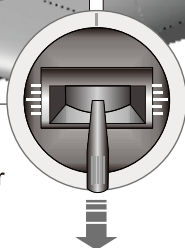

We recommend the following LiPo battery:
6S 22.2V 4000mAh~6S 22.2V 5200mAh
Discharge rate of C ≥ 35C

Pushrod instructions

Nose Cabin door pushrod length

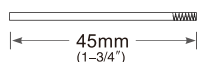

Pushrod diameter $\varnothing 1.2\text{mm}$

Nose cabin door pushrod mounting hole

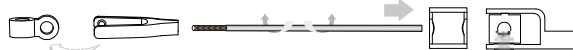

Nose Cabin door pushrod length

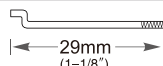

Pushrod diameter $\varnothing 1.2\text{mm}$

Nose cabin door pushrod mounting hole



Rear cabin door pushrod length

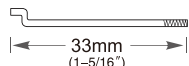

Pushrod diameter $\varnothing 1.2\text{mm}$

Rear cabin door pushrod mounting hole

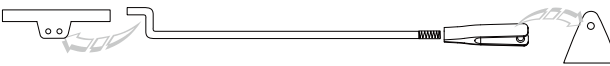

Aileron pushrod length

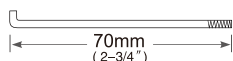

Pushrod diameter $\varnothing 1.5\text{mm}$

Aileron pushrod mounting hole



Flap pushrod length

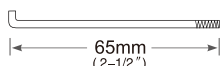

Pushrod diameter $\varnothing 1.5\text{mm}$

Flap pushrod mounting hole

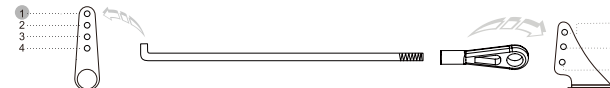

Elevator pushrod length

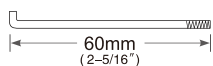

Pushrod diameter $\varnothing 1.5\text{mm}$

Elevator pushrod mounting hole

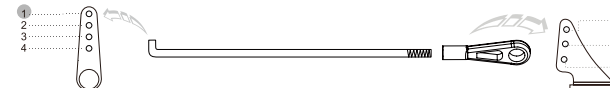

Rudder pushrod length

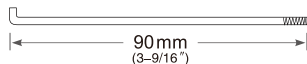

Pushrod diameter $\varnothing 1.5\text{mm}$

Rudder pushrod mounting hole



Important additional notes

The Y-type clevis used in this product is equipped with a transparent silicone ring for secondary reinforcement, which can effectively prevent the clevis from accidentally loosening.

As shown in the following figure, when you buckle the clevis into the control surface horn, use the silicone ring to cover the clevis.

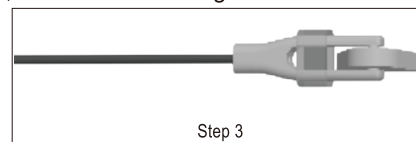
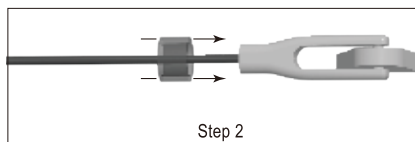
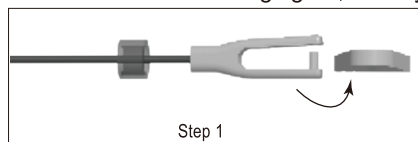

Center of Gravity

Correct Center of Gravity ("CG") is critical for enabling safe aircraft stability and responsive control. Please refer to the following CG diagram to adjust your aircraft's Center of Gravity.

- Depending on the capacity and weight of your chosen flight batteries, move the battery forward or backward to adjust the Center of Gravity.
- If you cannot obtain the recommended CG by moving the battery to a suitable location, you can also install a counterweight to achieve correct CG. However, with the recommended battery size, a counterweight is not required. We recommend flying without unnecessary counterweight.

As the photo show, We marked the center of gravity on the bottom of the Main wing. Please confirm the CG based on this marked position.

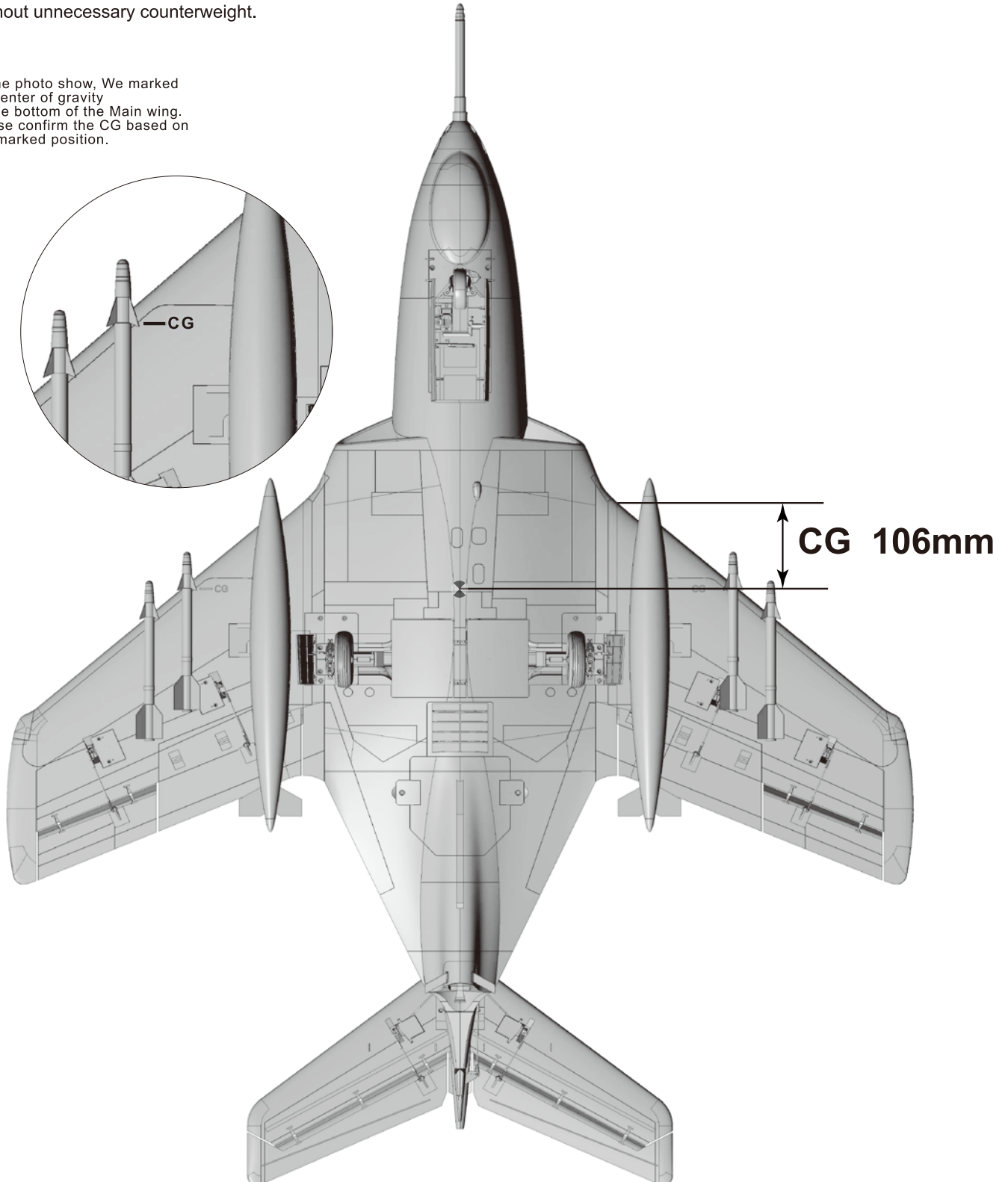

Control Direction Test

After installed the plane, before flying, we need a fully charged battery and connect to the ESC, then use radio to test and check that every control surface work properly.

Aileron

Stick Left



Stick Right



Rudder

Stick Left



Stick Right



Elevator

Stick down



Stick up



Flaps

Flaps down



Dual Rates

According to our testing experience, use the following parameters to set Aileron/Elevator Rate. Program your preferred Exponential % in your radio transmitter. We recommend using High Rate for the first flight, and switching to Low Rate if you desire a lower sensitivity. On successive flights, adjust the Rates and Expo to suit your preference.

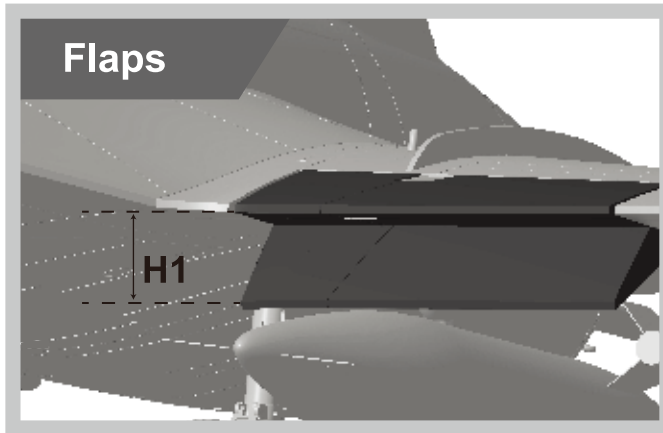
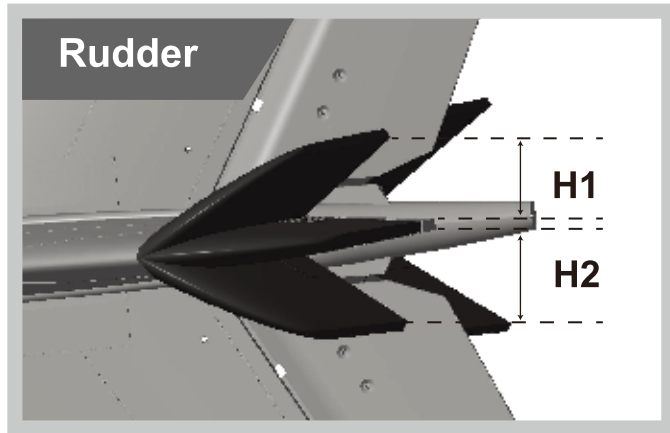
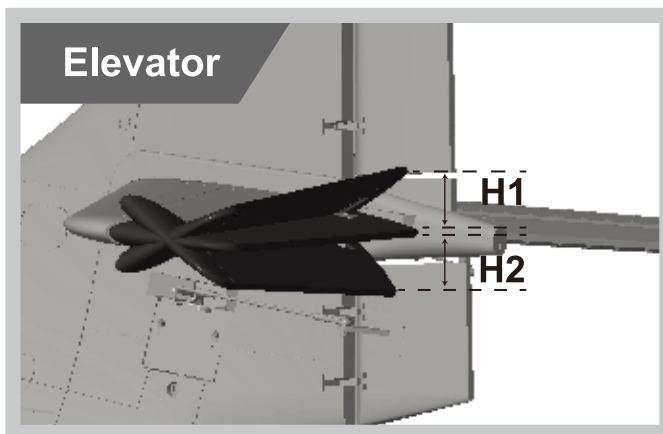
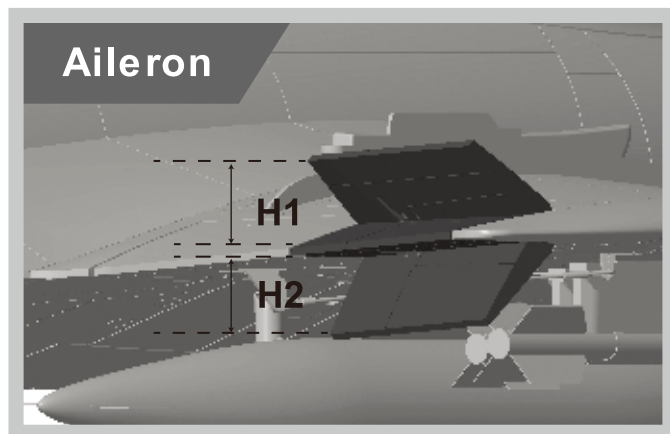

	Aileron (Measured closest to the fuselage)	Elevator (Measured closest to the fuselage)	Rudder (Measured from the bottom)	Flaps
Low Rate	H1/H2 20mm/20mm D/R Rate: 80%	H1/H2 24mm/24mm D/R Rate: 80%	H1/H2 17mm/17mm D/R Rate: 60%	H1 19mm
High Rate	H1/H2 25mm/25mm D/R Rate: 100%	H1/H2 26mm/26mm D/R Rate: 100%	H1/H2 22mm/22mm D/R Rate: 80%	H1 28mm

⚠ Flight Note:

- Standard gyro. This F9F has been equipped with gyro. It has been preset with parameters suitable for F9F aircraft flight. You do not need to set the gyro again, but need to pay attention to the use of stability enhancement mode for flight(the red LED light of gyro is always on);
- Gyro setting: Aileron sensitivity: 40% Elevator sensitivity: 40%
Rudder sensitivity: 40%
Sensitivity level: medium sensitivity
- Flap down, the elevator does not need to be trimmed;
- The elevator needs some upwarped in order for the plane to level off.
Please refer to the right photo to set the elevator center position.

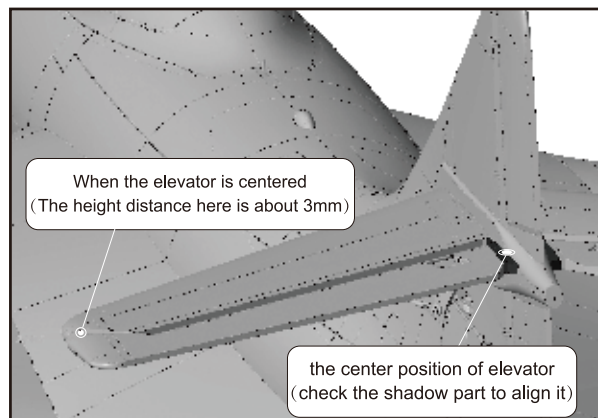

Servo Direction

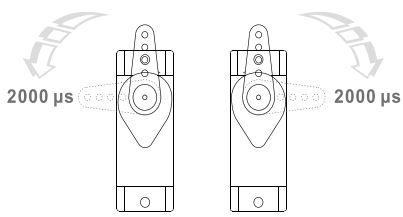

The servo positive or reverse rotation is defined as follows:
 When servo input signal change from 1000 μ s to 2000 μ s,
 The servo arm is
rotated clockwise, its positive servo.
 The servo arm is
rotated counterclockwise, its reverse servo.

If you need to purchase another brand's servo, please refer to the following list to choose a suitable servo.

Position	Servo regulation	No.	Pos. / Rev.	Cable length
Nose gear steering servo	9g Digital-Hybrid	1	Positive	400mm
Rear cabin door(L)	9g Digital-Hybrid	2	Reverse	200mm
Rear cabin door(R)	9g Digital-Hybrid	3	Positive	200mm
Flap(L)	9g Digital-Hybrid	4	Positive	200mm
Flap(R)	9g Digital-Hybrid	5	Positive	200mm
Aileron(L)	9g Digital-Hybrid	6	Positive	300mm
Aileron(R)	9g Digital-Hybrid	7	Positive	300mm
Elevator(L)	9g Digital-Hybrid	8	Positive	400mm
Elevator(R)	9g Digital-Hybrid	9	Reverse	400mm
Rudder	9g Digital-Hybrid	10	Positive	300mm

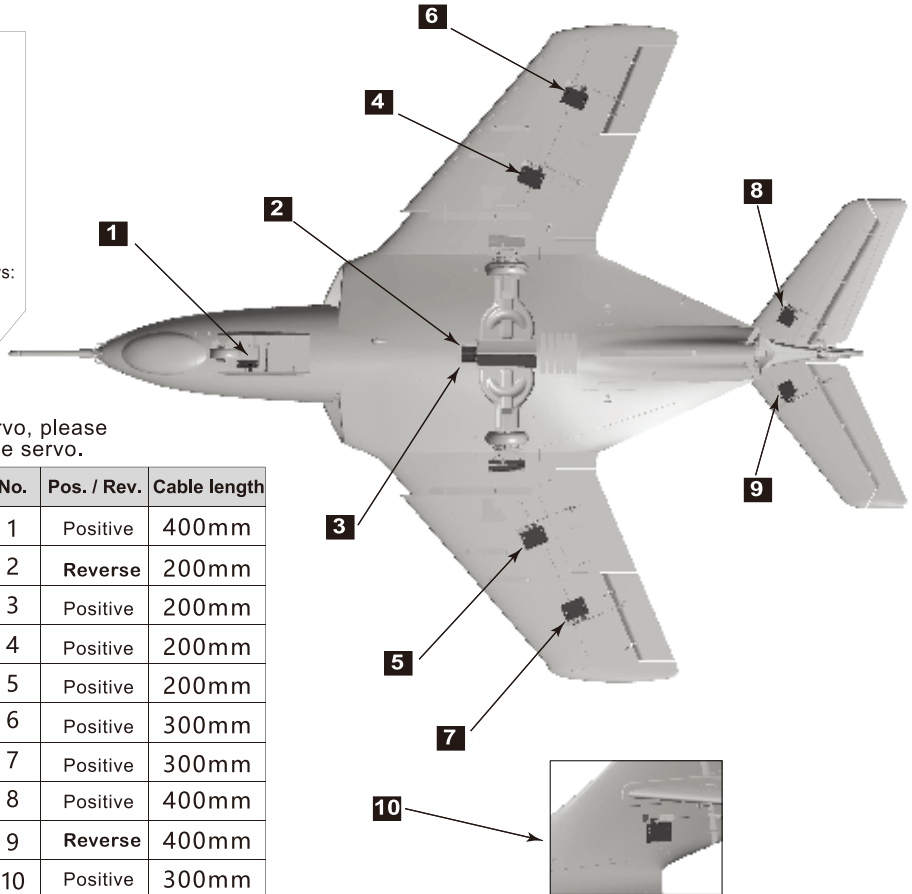

Motor Specification

#MOI36585
 3658-2150KV

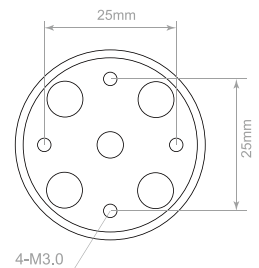
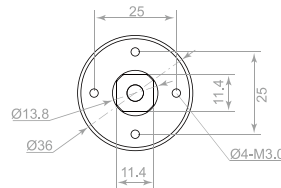
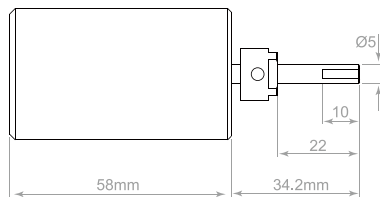
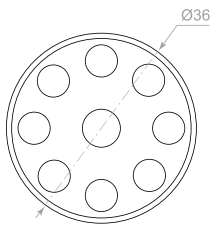

Unit:mm

Item No.	Fan size	Motor specifications	Voltage (V)	Current (A)	Max power (W)	Thrust (g)	Efficiency (g/w)	Speed (rpm)	Weight (g)
E72314	80mm 12-Blade	3658-2150KV	22.2	95	2100	3550	1.7	47700	340



Dongguan Freewing Electronic Technology Ltd
HK Freewing Model International Limited

Add.: FeiYi Building, face to Labor Bureau, Fumin Middle Road, Dalang Town,
Dongguan City, Guangdong Province, China

Web: <http://www.sz-freewing.com> www.freewingmodel.com

Email: freewing@sz-freewing.com

Tel: 86-769-82669669 Fax: 86-769-82033233

东莞市飞翼电子科技有限公司
香港飞翼模型国际有限公司

地址: 广东省东莞市大朗镇富民中路402-408号飞翼楼二楼

Web: <http://www.sz-freewing.com> www.freewingmodel.com

Email: freewing@sz-freewing.com

Tel: 86-769-82669669 Fax: 86-769-82033233

