

TRX4[®]

Front Assembly

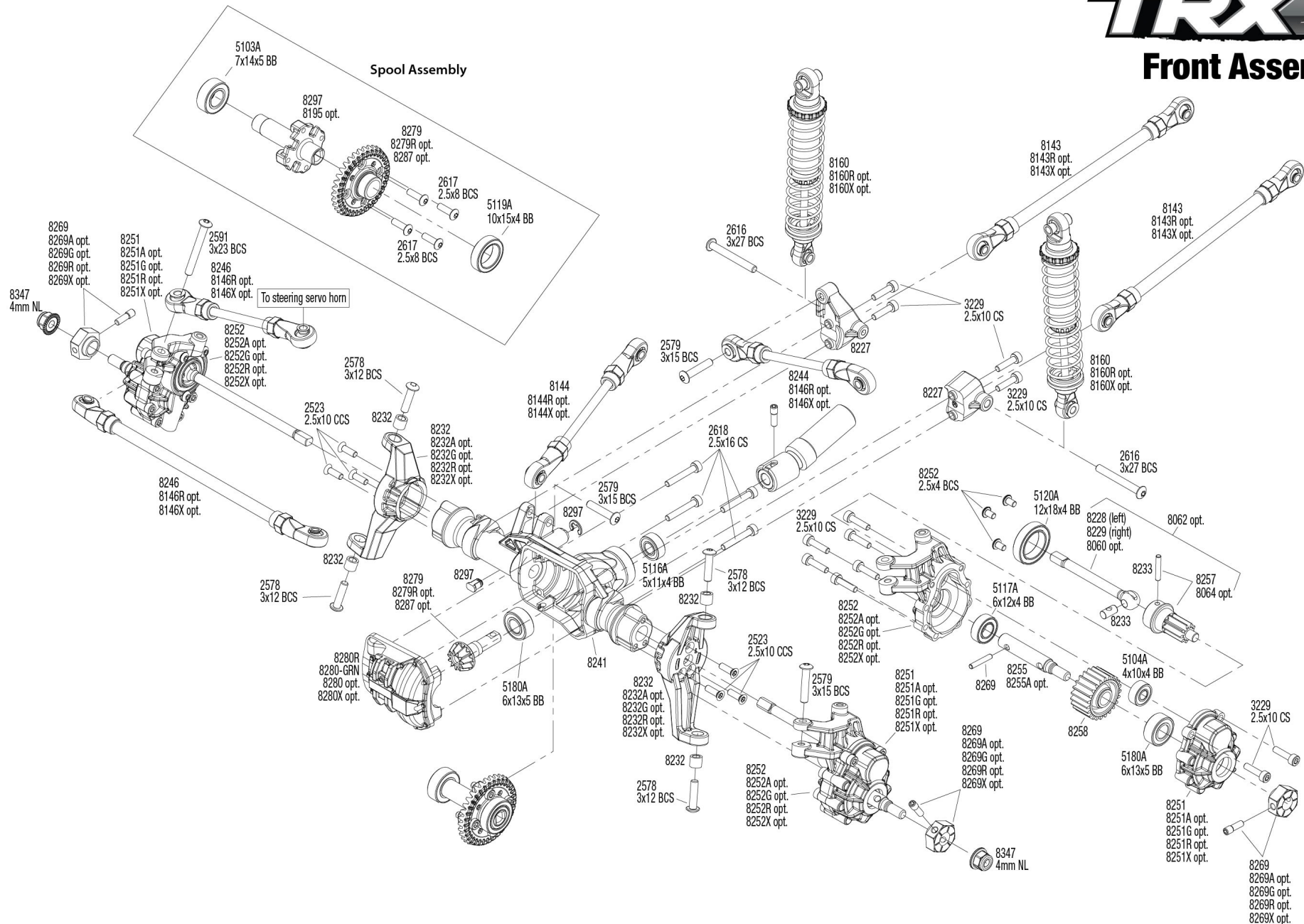

See Parts List for a complete listing of optional accessories.

Specifications on this page are subject to change without notice. Every attempt has been made to ensure the accuracy of this drawing; however, Traxxas cannot be held responsible for typographical or other errors.

REV 240125-R05



Link Dimensions

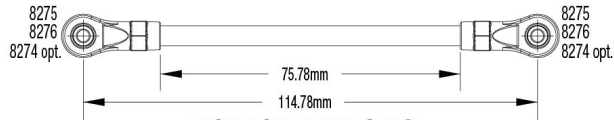

FRONT LOWER LINK (QTY. 2)

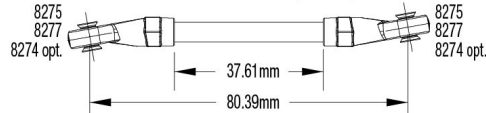

FRONT UPPER LINK (QTY. 1)

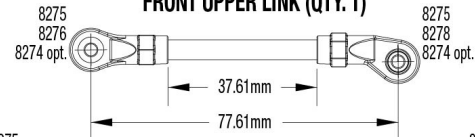

PANHARD BAR (QTY. 1)

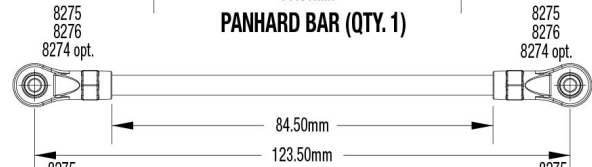

REAR LOWER LINK (QTY. 2)

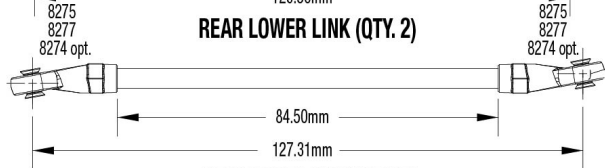

REAR UPPER LINK (QTY. 2)

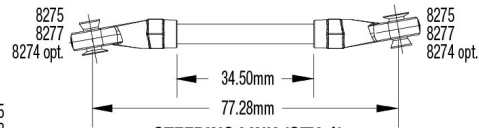

STEERING LINK (QTY. 1)

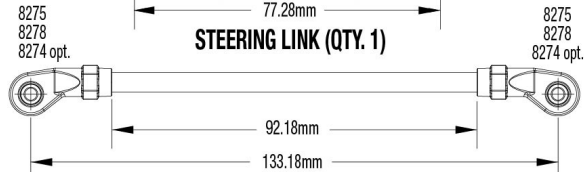

DRAG LINK (QTY. 1)

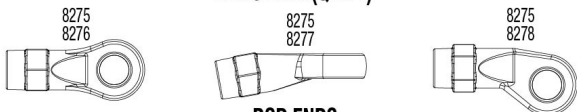

ROD ENDS

For standard hollow ball replacement, use part #5349.



Modular Assembly

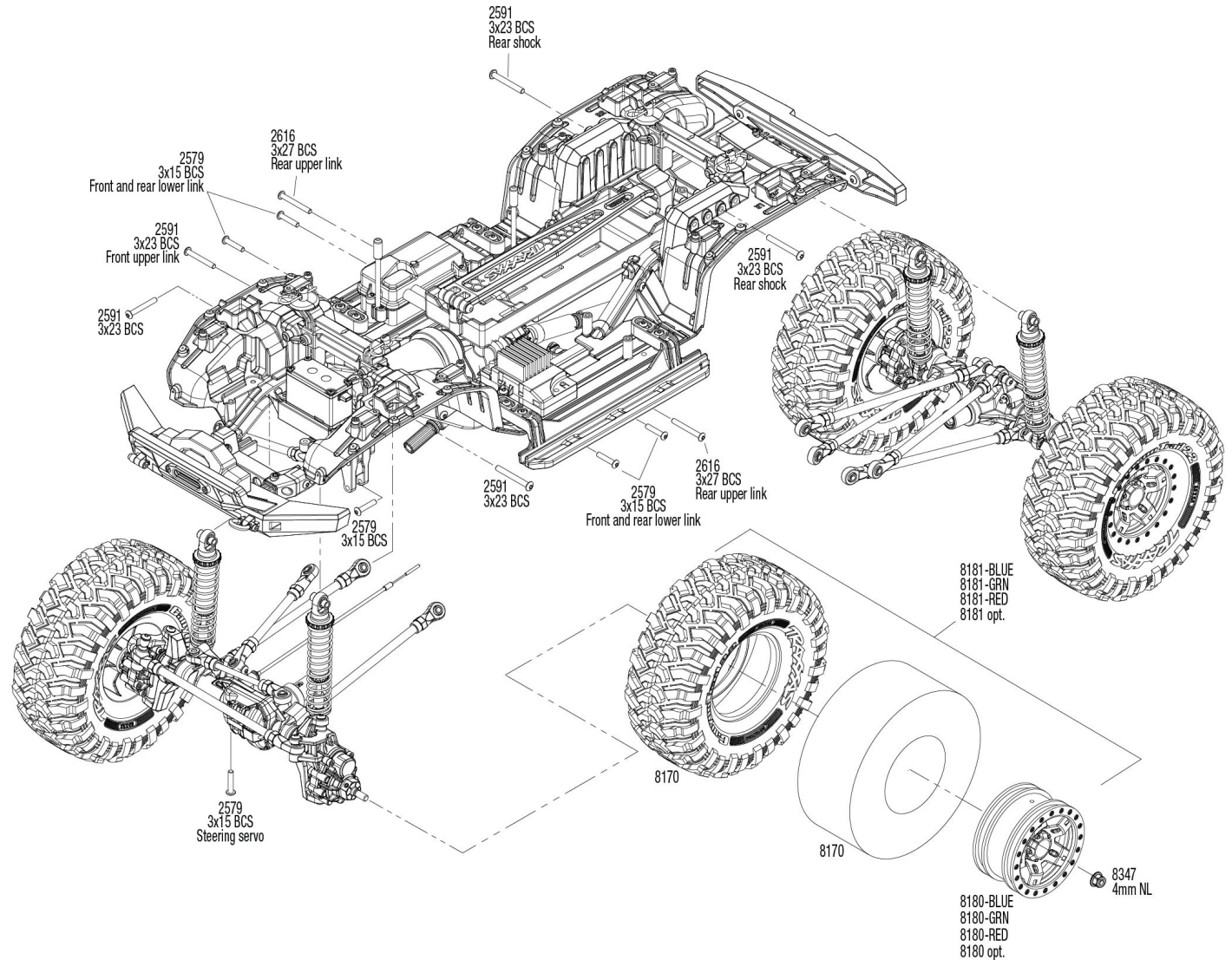

See Parts List for a complete listing of optional accessories.

Specifications on this page are subject to change without notice. Every attempt has been made to ensure the accuracy of this drawing; however, Traxxas cannot be held responsible for typographical or other errors.

Shock Assembly

