

15T-Aul-arm-02:

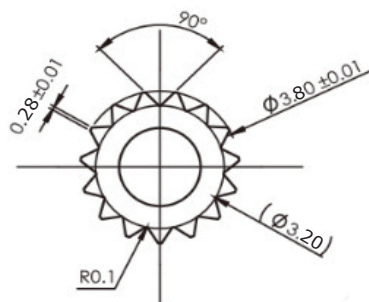
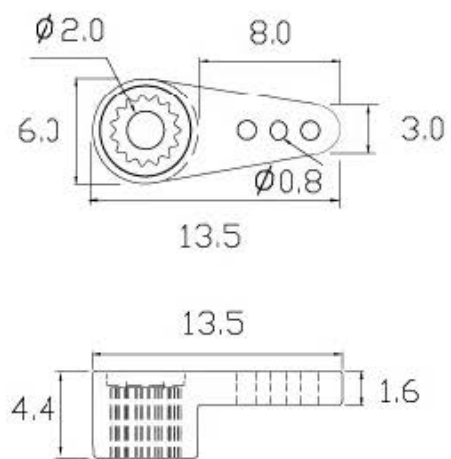

output shaft spline 15T $\phi 3.8$ mm