

100^{mm} *TURBO* BUSHMASTER

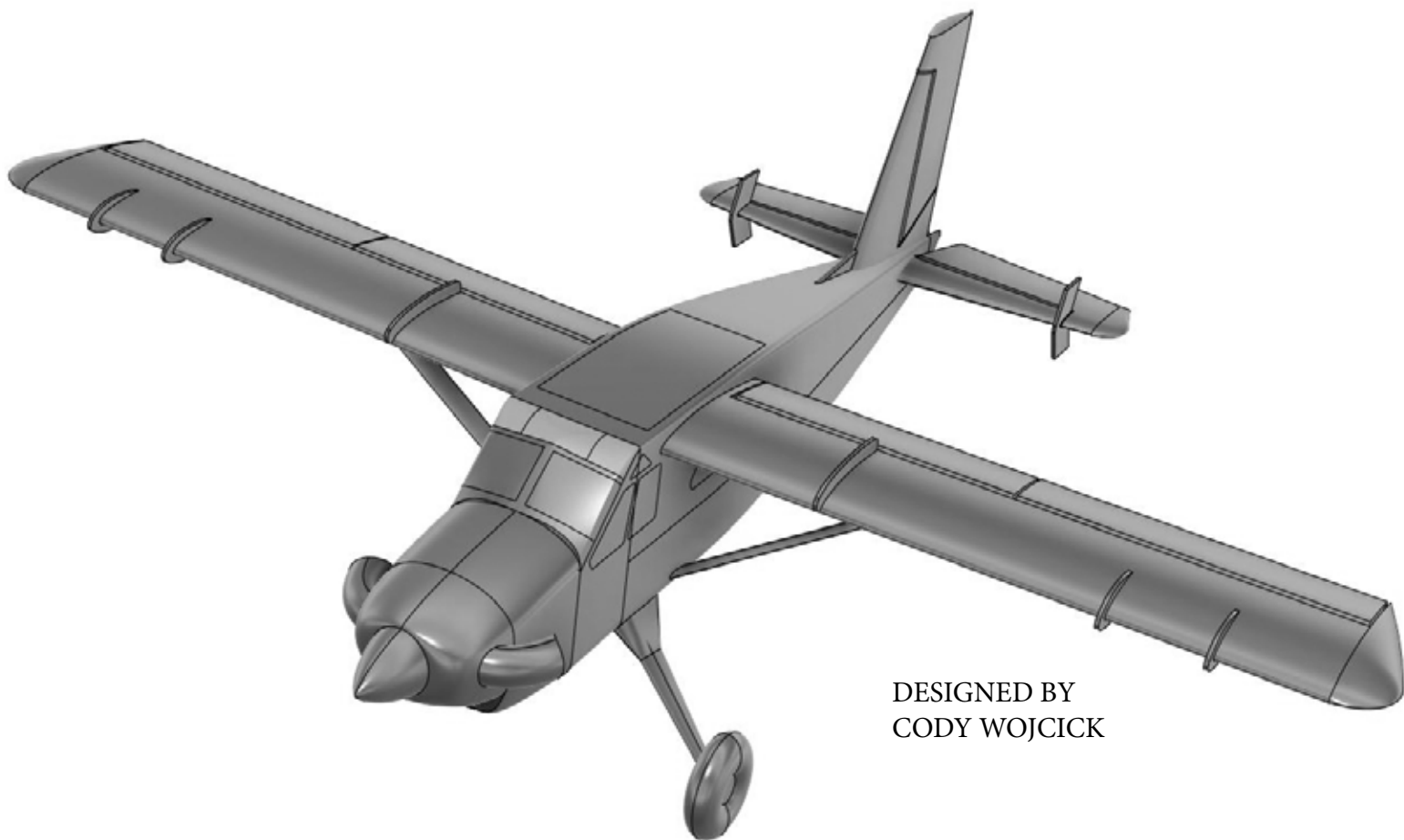

DESIGNED BY
CODY WOJCICK

LEGACY
A V I A T I O N

BY **EXTREME FLIGHT** 

Please take a few moments to read this instruction manual before beginning assembly. We have outlined a fast, clear and easy method to assemble this aircraft and familiarizing yourself with this process will aid in a quick, easy build.

Please read the following paragraph before beginning assembly of your aircraft!

THIS IS NOT A TOY! Serious injury, destruction of property, or even death may result from the misuse of this product. Extreme Flight RC is providing you, the consumer with a very high quality model aircraft component kit, from which you, the consumer, will assemble a flying model. It is beyond our control to monitor the finished aircraft you produce. Extreme Flight RC will in no way accept or assume responsibility or liability for damages resulting from the use of this user assembled product. This aircraft should be flown in accordance to the AMA safety code. It is highly recommended that you join the Academy of Model Aeronautics in order to be properly insured, and to operate your model at AMA sanctioned flying fields only. If you are not willing to accept ALL liability for the use of this product, please return it to the place of purchase immediately.

Extreme Flight RC, Ltd. guarantees this kit to be free of defects in materials and workmanship for a period of 30 DAYS from the date of purchase. All warranty claims must be accompanied by the original dated receipt. This warranty is extended to the original purchaser of the aircraft kit only.

Extreme Flight RC in no way warranties its aircraft against flutter. We have put these aircraft through the most grueling flight tests imaginable and have not experienced any control surface flutter. Proper servo selection and linkage set-up is absolutely essential. Inadequate servos or improper linkage set up may result in flutter and possibly the complete destruction of your aircraft. If you are not experienced in this type of linkage set-up or have questions regarding servo choices, please contact us at info@extremeflightrc.com or 770-887-1794. It is your responsibility to ensure the airworthiness of your model.



Two points to start: In this build, we will use epoxy glue in several steps. Prompt cleanup of any excess epoxy is important. We recommend you use denatured alcohol, available at most hardware and home-improvement stores.

When you unpack your airplane, note that in order to remove the main hatch, you must release the latch and then *pull forward* to release the hatch.

100^{mm} TURBO BUSHMASTER

35-38CC / 12S

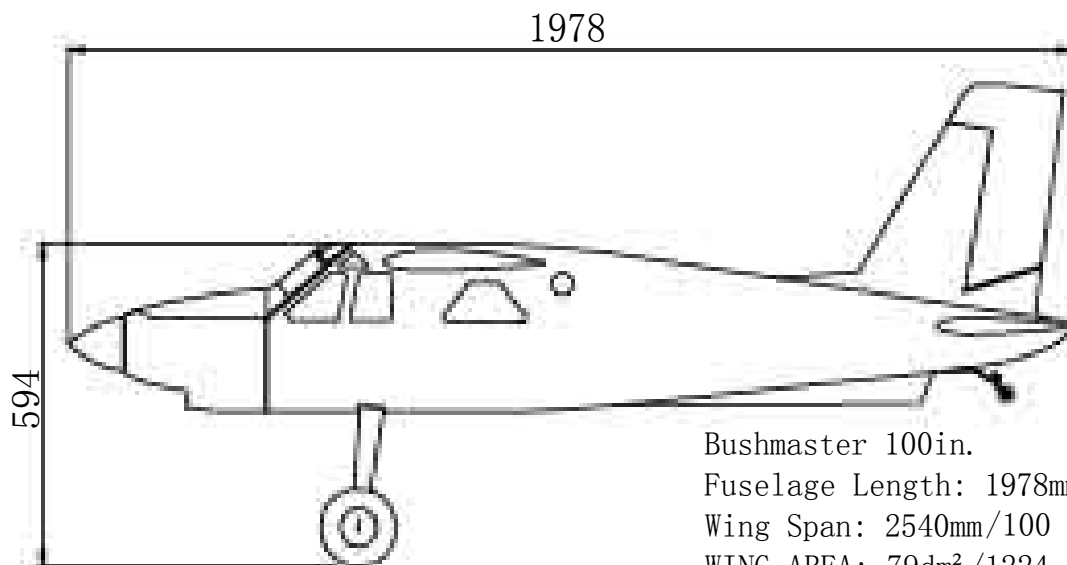

Bushmaster 100in.
Fuselage Length: 1978mm/77.9 in.
Wing Span: 2540mm/100 in.
WING AREA: 79dm²/1224.5 sq. in.

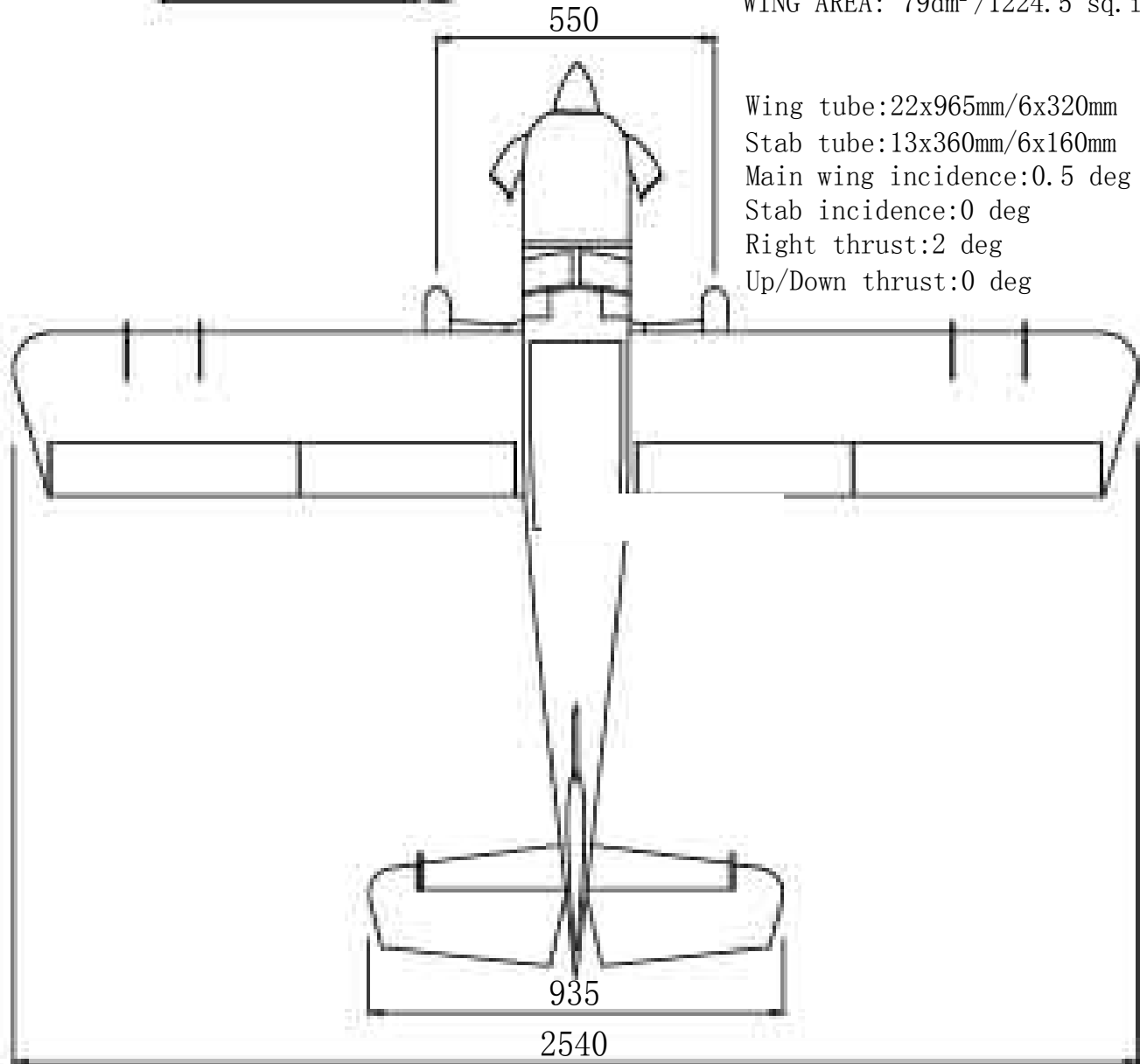

Wing tube: 22x965mm/6x320mm
Stab tube: 13x360mm/6x160mm
Main wing incidence: 0.5 deg
Stab incidence: 0 deg
Right thrust: 2 deg
Up/Down thrust: 0 deg

SPECS

WingSpan: 100"

Length: 78"

Wing area: 1224 sq. in.

Center of Gravity Range (Measured from wing leading edge at root): 3.3-4.25 " (89-108mm)

Our preferred CG is center of the wing tube.

Spinner: 3.5"

Weight: 16 lbs (elec, no lipo)

Control settings:

Elevator: Low Rate 8-10 deg. 15-20% expo
3D Rate 45 deg. 60-70% expo

Aileron: Low Rate 15-20 deg. 20-30% expo
High Rate 38-40 deg. 60-70% expo (For best roll rate, mix flaps to ailerons)

Rudder: Low Rate 20 deg 40-45% expo
High Rate 45 deg. 70-80% expo

Flaps: 40 degrees full deflection with 5% down elevator mix at full deflection

Power system:

GAS

Desert Aircraft DA 35

Prop: Carbon gas 20 x 8

Great Power GP-38

Prop: Carbon gas 20 x 8, 20 x 9

FlowMaster 14 oz. fuel tank

ELECTRIC

Motor: Xpwr 35cc or 40cc

Standoffs: Blazing Star Standard Extra Long Standoff Set

ESC: Castle Creations HV-120 Edge ESC (Must Use Firmware v 4.22) or Scorpion Tribunus II 130A

Battery: Two 6S 3300-4000 mAh batteries in series (12S) for XPWR 35, or 4000-5000mah for 40cc

Prop: 21x10 electric for 35cc or 22x10 for 40cc

Servos:

Qty. 7 full size, metal gear hi-torque servos (300 oz/in minimum). MKS HV-1220 or better

Qty. 1 throttle servo, MKS HV-1250 recommended.

Qty. 4 Extreme Flight 1.5 inch single servo arms (tapped 3mm) for ailerons

Qty. 3 Extreme Flight 1.5 inch single servo arms (tapped for 3mm) for elevators and rudder

QTY 1 Metal gear mini servo for tailwheel w/ Extreme Flight mini servo arm 1.25"

Servo Extensions:

Qty. 4 Extreme Flight 20 AWG 6 inch for Rx to Ailerons

Qty. 2 Extreme Flight 20 AWG 12 inch for Ailerons

Qty. 1 Extreme Flight 20 AWG 18 inch for Throttle servo

Qty. 4 Extreme Flight 20 AWG 36 inch for Elevators, rudder, and tail wheel

A few tips to ensure success:

1. We are very pleased with the level of craftsmanship displayed by the builders in our factory. Through hundreds of grueling test flights containing maneuvers that no aircraft should be subjected to, our prototypes have remained rigid and completely airworthy. Having said that, it is impossible for us to inspect every glue joint in the aircraft. Take a few minutes and apply some medium CA to high stress areas such as the aileron servo mounting trays, landing gear mount, anti rotation pins, wing and stab root ribs, etc.

2. Having survived the journey half way around the world while experiencing several climate changes, it is not uncommon for a few wrinkles to develop in the covering. Fear not! These are not manufacturing defects, and are easily removed with a little bit of heat. Use a sealing iron to go over all seams, stripes and sharp points in the covering scheme. You may want to apply a drop of clear fingernail polish at the tip of all sharp points to prevent them from lifting. To remove wrinkles use a 100% cotton tee-shirt or microfiber cloth and your heat gun and heat the covering while gently rubbing the covering onto the wood with the t-shirt or cloth. Be careful not to use too much heat as the covering may shrink too much and begin to lift at the edges. Take your time, and a beautiful, paint like finish is attainable. If you need to repair any covering during the life of your aircraft, the colors are:

Oracover colors

White/Red/Black/Charcoal/Silver color scheme:

Ferrari Red #23
White #10
Silver #91
Black #71
Pearl Charcoal #77

Ultracote colors

True Red-#HANU866
White-# HANU870
Silver-#HANU881
Black-#HANU874
Pearl Charcoal-#HANU846

White/Midnight Blue/Cub Yellow color scheme:

Cub Yellow #30
Dark Blue #52
White #10

Cub Yellow-#HANU884
Midnight Blue- # HANU885
White-# HANU870

3. DO NOT SKIMP ON SERVOS! Your aircraft is equipped with very large control surfaces that deflect up to 45 degrees. A lot of servo power is required to prevent flutter and to maintain the required deflection for maneuvers. We absolutely recommend the use of METAL GEARED servos with a minimum of 300 oz. inches of torque.

4. Use a high quality epoxy for installing the composite control horns and hinges. We highly recommend the use of Pacer Z-Poxy 30 minute formula. We have used this glue for many years with zero failures. We also use the Loctite HYSOL brand epoxies with their very convenient application gun. If you need to clean any excess epoxy, we recommend a paper towel and denatured alcohol.

5. Your aircraft is built using very modern construction techniques and is very light weight for its size. As with any high performance machine, regular inspection and maintenance is a must. While disassembling your aircraft after a flying session, pay close attention and inspect glue joints, linkages and loose covering to be sure the airframe is sound. A few minutes spent doing this will help maintain airframe longevity.

6. We recommend the use of blue Loctite threadlocker when installing fasteners into your aircraft.

1

Locate the carbon fiber landing gear and the Main Wheel hardware pack. The gear has a front, and a back. To identify the front, note that the gear sweeps slight forward when installed. Use 4 screws and washers with loctite to install the landing gear as shown. Locate the gear “cuff” fairings. Test fit them to the landing gear. We recommend “Goop” adhesive to attach the cuffs. Place masking tape to protect the gear surface as shown, apply a large dollop of Goop, slide on the cuff, and affix with masking tape until cured.

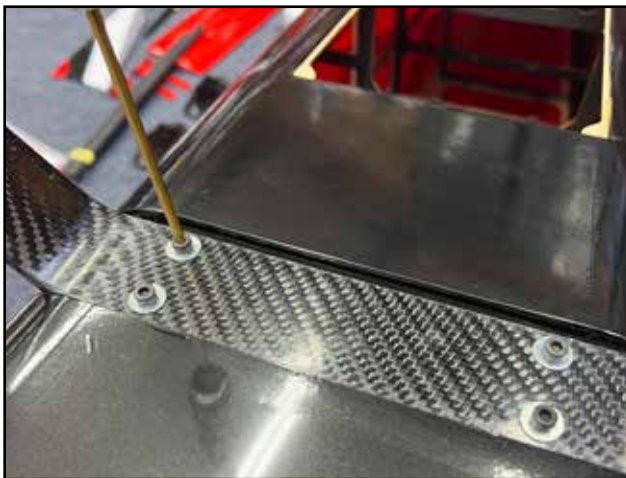
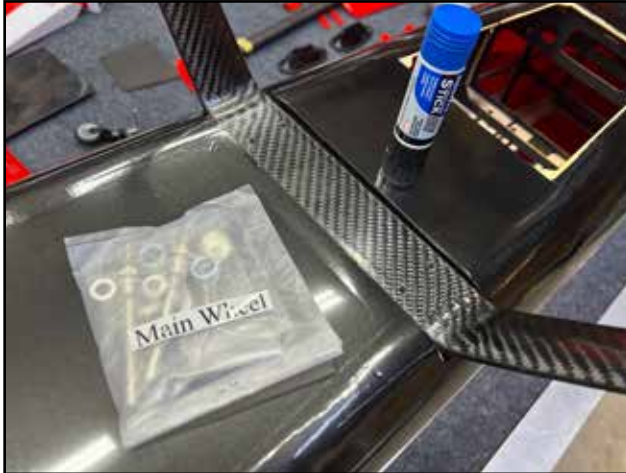

Attach the wheel axles to the landing gear by tightening the locking nuts. Slide on the wheels, and the wheel spacers. Note the axles have flat areas to accept the wheel collar set screws. Put loctite on the set screw, then install and tighten the wheel collars. Locate the tailwheel and hardware bag. Using loctite, mount the tailwheel to the fuselage using three screws as shown. Using a small amount of epoxy glue on the wooden tabs, install the fin on the bottom of the fuselage.



Assemble the tailwheel pushrod with the nylon ball link ends as shown. Remove the covering over the tailwheel steering servo mount location as shown. Install the servo wire extension onto the servo and mount the servo. Install the pushrod between the servo arm and the tailwheel arm with 2mm screws, washers, and locking nuts. Now is a good time to install the MPX wiring plugs into the pre-fit locations in the fuselage, using wood screws, as shown.

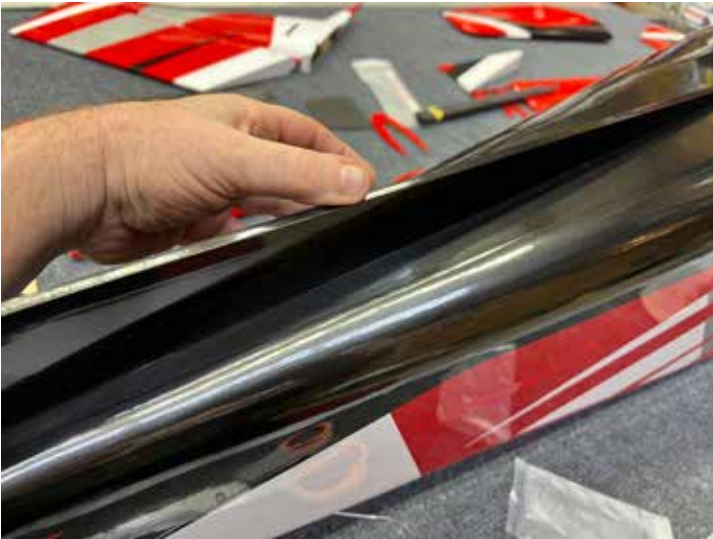

Locate the stab/rudder (it is pre-hinged for you), its hardware pack, and your servo, wire extension, and servo arm. Remove the wood tab on the bottom of the stab as shown. Locate the control horns. Sand them lightly as shown in the area which will be glued. Assemble the plastic ball links onto the pushrods, we use a cordless drill to assist. Note that the pushrods has one left hand, and one right hand thread. Assemble the horns with the square base plate, and the pushrod, with a screw, washers, and locking nuts as shown.



5

Remove the covering in the area between the slots on the rudder as shown. Test-fit the horn assembly into the slots. It should be tight, but should go in with moderate force. You may need to clean out the slots with the hobby knife. Place epoxy glue into the slots and onto the horns. Push the horns into the slot, seat it firmly. If any epoxy glue squeezes out, clean up with a paper towel soaked with denatured alcohol.

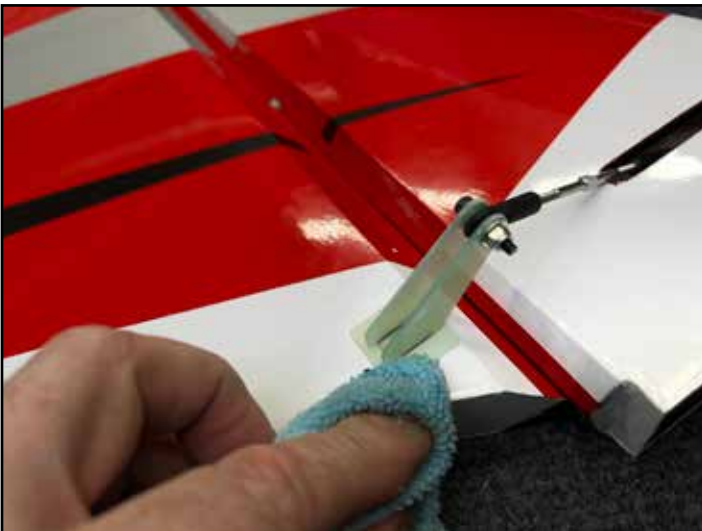
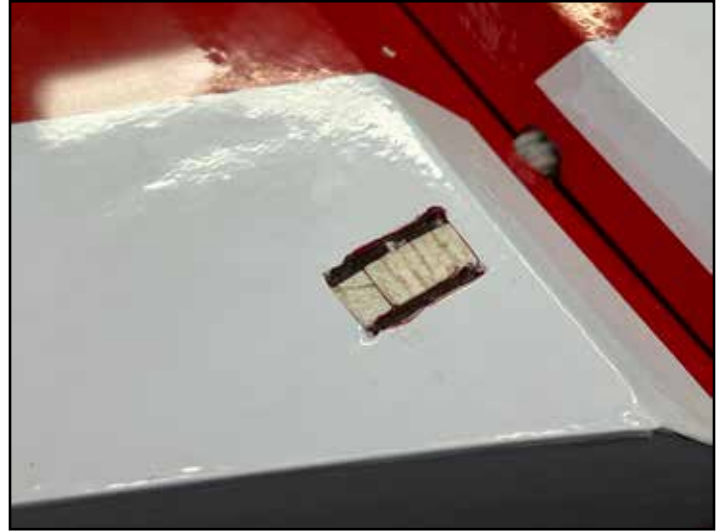

6

Locate the rudder extension piece which mounts to the fuselage. Check its fit as shown. Glue to the fuselage with epoxy and use masking tape to hold the position while it cures. Now is a good time to center your servos using your radio system or a servo tester. Mount your rudder servo. The servo mounts inside the vertical stab, go slowly and patiently as you place the servo into its mount. Note that the slot in the stab is placed to fit most common servos and arms, if your servo and arm combo happens to rub the wood, you can trim the slot using a hobby knife and straight edge.



7 Install your servo arms, use loctite on the arm screws. Attach the pushrod to the arm with screw and washers, use loctite or a locking nut for safety. Because the pushrod has one left, and one right hand threads, you can adjust the length of the pushrod by rotating it. Adjust the length of the pushrod so that the servo arm is 90 degrees as shown when the rudder is centered.

Run your servo wire extension through the plastic tube in the fuselage (now is a good time to also run your elevator servo extensions). Because we do not expect to remove the vertical stab, we used heat shrink tubing on the wire connection. Using the carbon mounting tube, install the stab onto the fuselage and attach with screws and large washers with loctite.

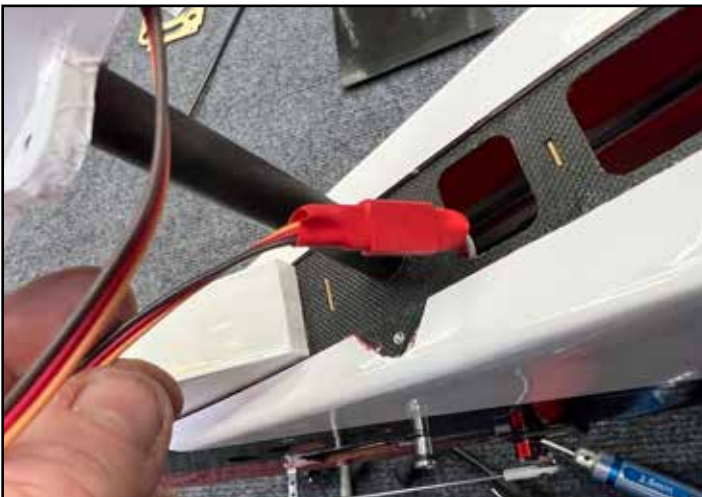

8

Locate the horizontal stabs/elevators. These are pre-hinged for you. Install the control horns exactly as you did on the rudder, and assemble the pushrods in the same way. Locate the fins for the stabs and install with screws and loctite as shown.

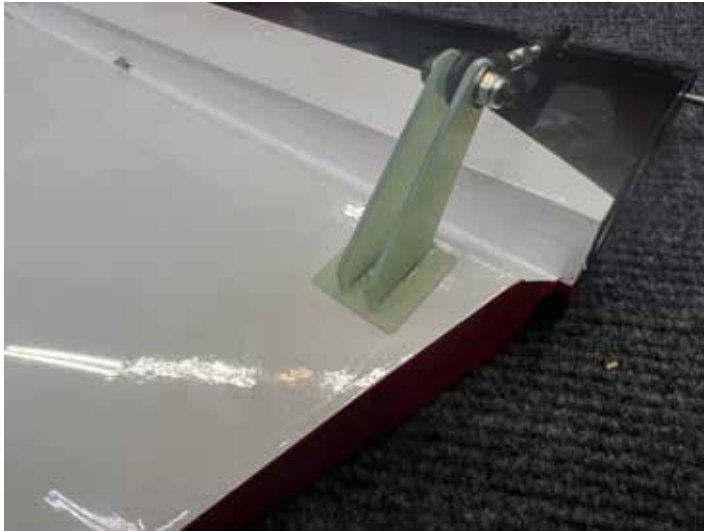

9

Locate the elevator servos, make sure they are centered. Plug them into the elevator wire extensions, because we expect to remove the stabs for transport, we use a servo plug lock on the connection. Using the front and rear carbon stab tubes, install the stabs and engage the stab locks as shown. Install the servo arm with loctite and attach the pushrod using loctite or locking nuts.



10

Locate the wings and Main Wing hardware pack. The wings are pre-hinged for you. Assemble the aileron and flap pushrods. All 8 control horns are identical. Sand and install them just as you did the rudder and elevator horns. Attach your servo wire extension to the aileron servo and feed through the wing. Some servos will not need an extension in the flap location. Install your servos, and install servo arms with loctite. Attach the pushrods and adjust to length as shown. We attached the MPX servo plug and used heat shrink tubing on the connections.

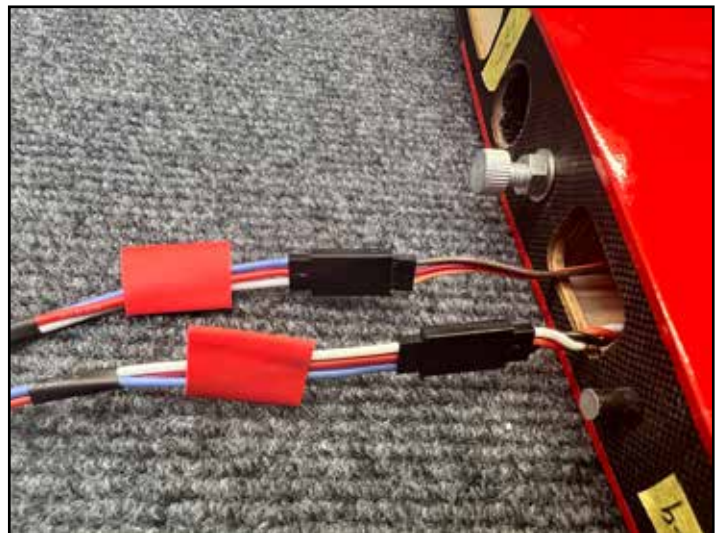
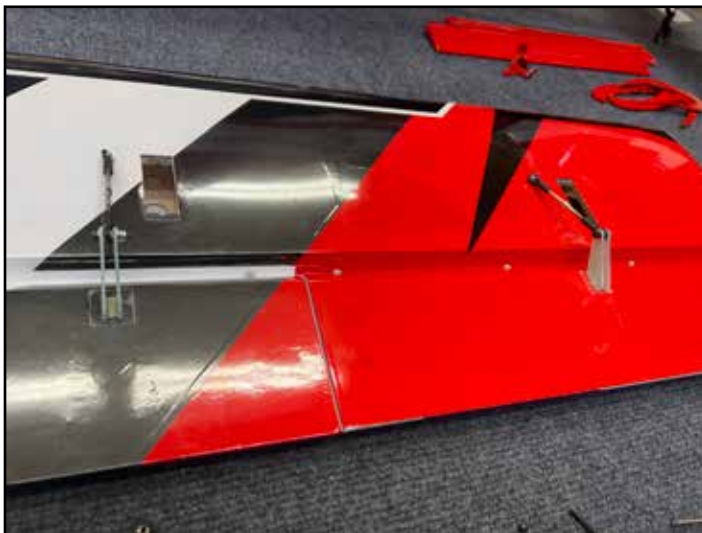
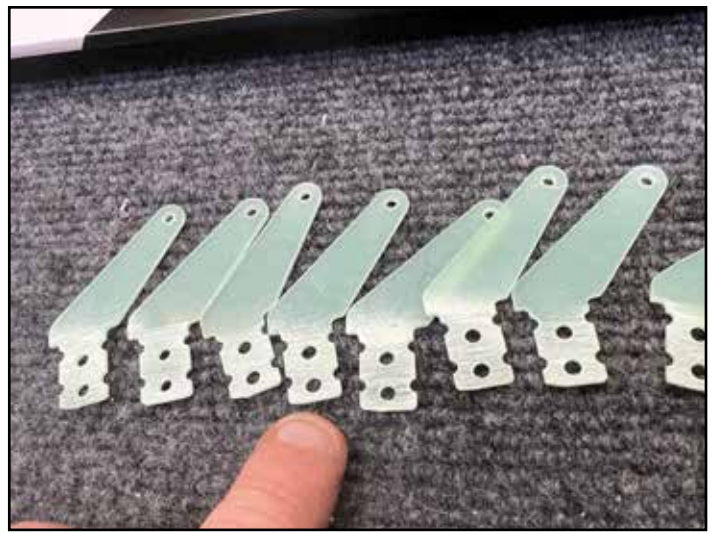

11

Locate the two carbon wing tubes and slide into the fuselage as shown. Locate the wing strut brackets. Cut a slit in the covering to allow the fuselage-side bracket to protrude. Loosely install the wing side and fuselage side brackets for the wing struts with loctite, but do not fully tighten. Slide the wings on the tubes all the way and close the wing latches inside the fuselage. Install the struts with long screws as shown. Once the struts are installed, then we know the strut brackets are in the correct locations. Tighten the strut bracket screws fully.



12

When the wings are removed from the airplane, the struts lay flat against the wing and will fit into the wing bags for transport. The long axle screw on the wing-side strut mount should be locked in place with a small drop of CA under the screw head.

The firewall of your aircraft is marked with two common bolt patterns for engine/motor mounting. One fits the GP-38/DA-35 gas engines, the other fits the XPWR 35cc and 40cc brushless motors. Drill the appropriate holes, first with a small bit diameter bit, then the correct final size.



13

The distance between the firewall surface and the front of the cowl on your bushmaster is approximately 163mm. This matches the length of common gas engines with their included standoffs/spacers. We do not want a tight spinner-to-cowl fit on the Bushmaster, leave 3-4mm for cooling air to enter the cowling.

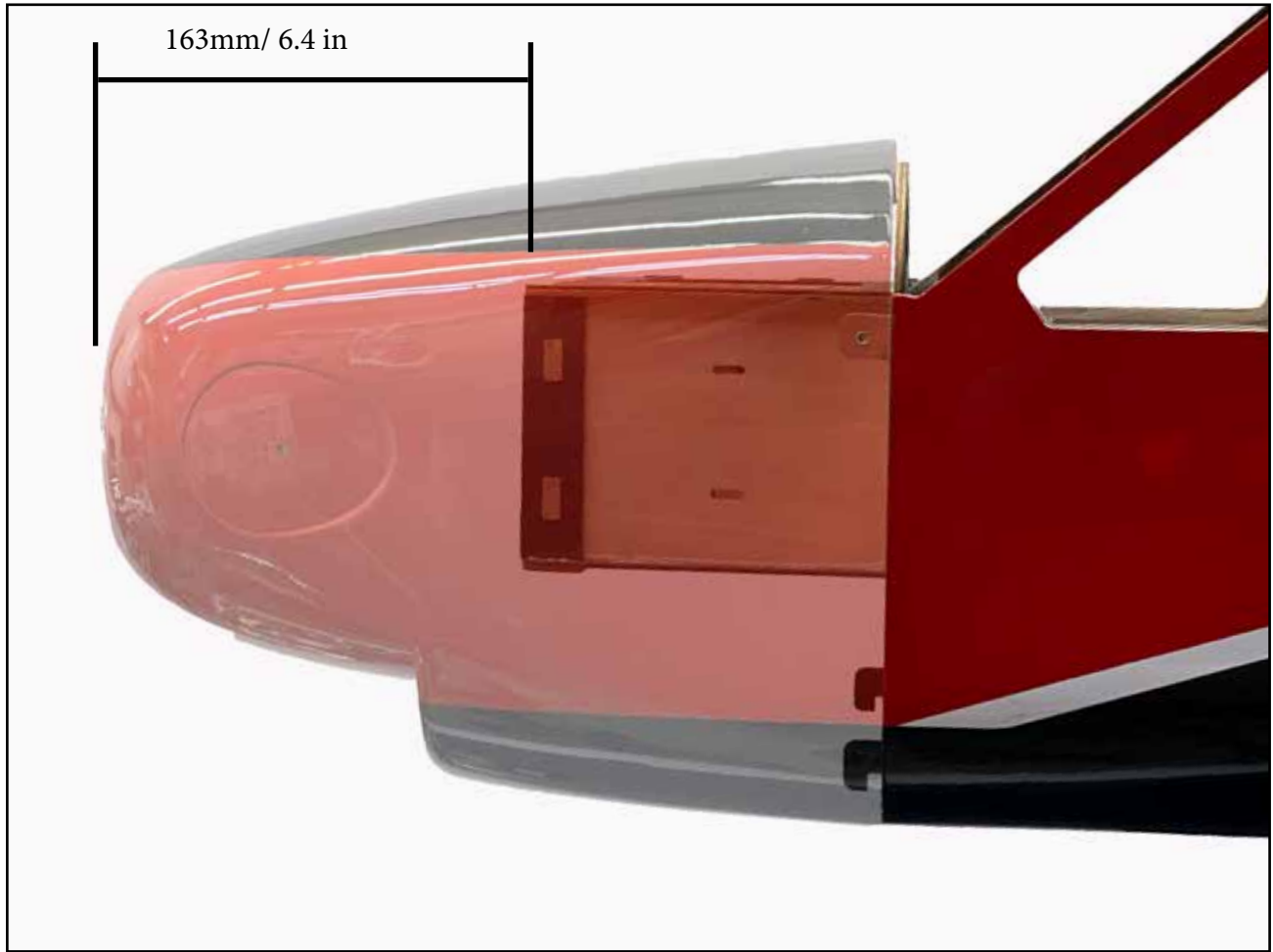

14

If using a gas engine, install onto the firewall, trimming the firewall as necessary to fit the carburetor. Use large diameter washers on the firewall to spread the load of the engine mounting screws, on front and back if possible. Use loctite to install the screws. Locate the "Thottle" hardware pack. Inside is a pushrod with one threaded end. The threaded end accepts the nylon ball link. This attaches to the carburetor throttle arm. The other end of the pushrod is smooth. The servo arm connector, when mounted on the servo arm, must spin freely. Tighten the servo connector nut as shown until the connector is snug and doesn't wobble, but can still rotate freely. Place a drop of medium CA as shown on the nut and apply CA accelerator. Install the throttle servo as shown, install and adjust the linkage, using loctite on the set screw. Install the throttle servo as shown, install and adjust the linkage, using loctite on the set screw.

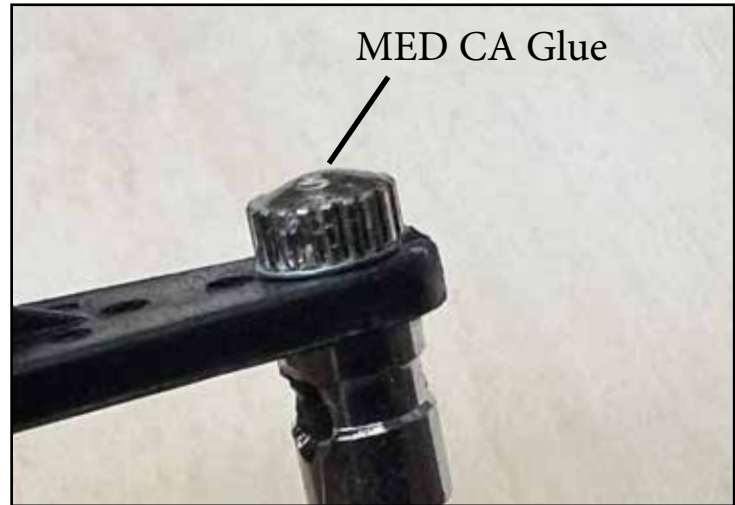
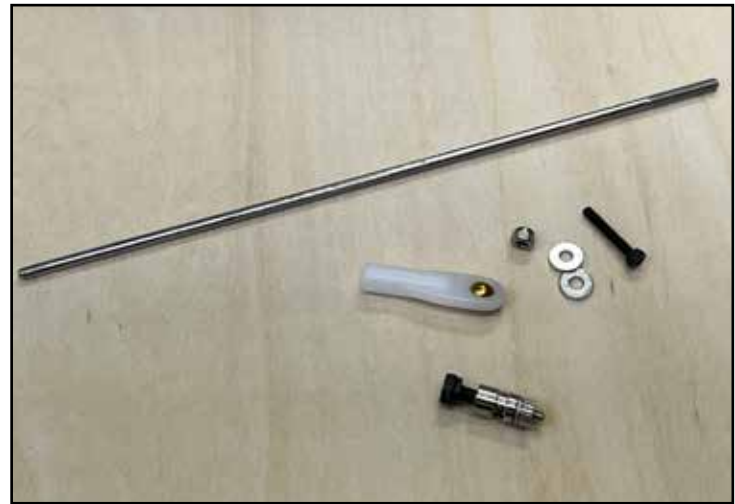
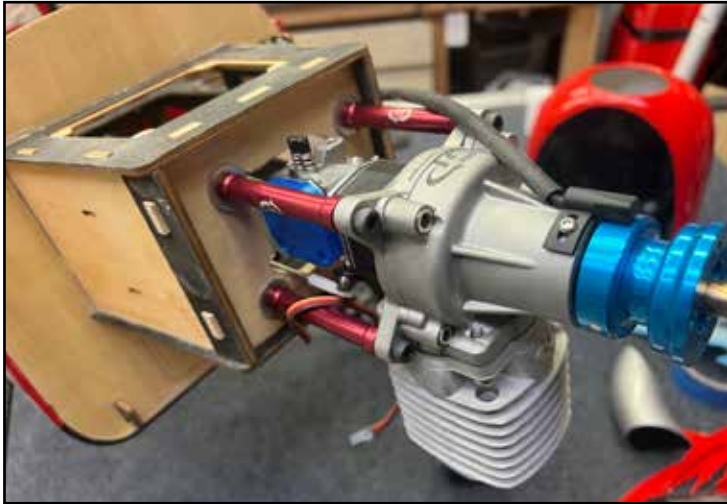

15

Mount the ignition unit to the side of the motor box using adhesive velcro, velcro straps, and cushioning foam if desired. To cut the bottom of the cowl for clearance and cooling, it is helpful to make a template from heavy paper or card stock or thin plywood. Use this template to mark the cowl before cutting. Wear eye and lung protection when cutting the fiberglass cowl. Go slowly, and test-fit frequently while working. For this installation we trimmed the muffler exit tube approximately 20mm (3/4 in). Mount your fuel tank directly under the wing spar on the tray. Use strong velcro straps. Hook up your fuel lines for carb, vent, and fill. Remember to place a loop in the vent line as shown so that fuel does not siphon out of the tank during maneuvers. Install your fuel dot.



16

If you are using either of the recommended brushless motors, the recommended Blazing Star stand-offs can be easily adjusted for proper length by adding or subtracting sections. Install with loctite. Install the turbo exhaust pipes with a screw and loctite.



17

If you are using a tuned pipe or canister exhaust on a gas engine, remove the panel on the bottom of the F1 former. We also recommend removing this panel if you are running an electric power system. Only if you are running a gas engine with stock muffler should you leave this panel in place. If you are using a tuned pipe or canister, we have included an exhaust mount with vibration-isolators which screws into the fuselage. For electric, remove the covering over the vents on the bottom access plate as shown and install with wood screws. There are additional cooling vents on the bottom of the fuselage which you can open if you need more cooling. Install the top plate onto the motor box with loctite. Locate the wing fence pieces, install onto the wing with epoxy glue. Clean up any excess epoxy with denatured alcohol.

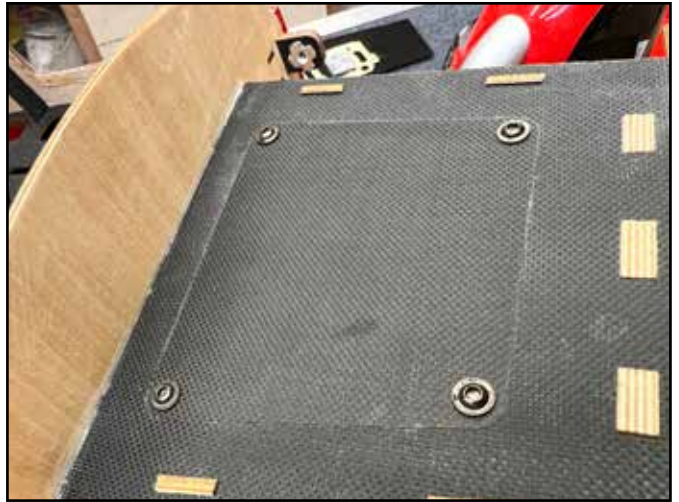

18

Balance your aircraft. We recommend balancing it so that it simply hangs level when lifted by the main wing tube. This is our favorite balance point for all types of flying. Set your control throws according to the setup sheet in the front of this manual. Test your power system in a safe manner on the ground, and range-check your radio system. Verify that your control surfaces move in the correct directions before flight.

The most common radio mix for the Bushmaster is to mix flaps to ailerons to give the function of large, full-span ailerons. This increases the roll rate. There are many other mixes you can experiment with on the Bushmaster. Check over the aircraft for any loose fasteners after the first flight and every several flights thereafter. We hope you enjoy your Bushmaster!

