

# **Musger Mg-19B**

**1/6**

## **Build instructions**



<b>Specifications</b>	
Wing Span	115.5 in / 2933mm
Wing Area	57sq dm
Flying weight	2.0kg-2.1g
Fuselage length	135cm
Scale	1 / 6

<b>Requires</b>
RC transmitter with at least 7 channels
Spoiler: 9g servos(ES08/DS395)*2
Aileron: 9g servos(ES08/DS395)*2
Rudder&Elevator: 17g Servo(ES3004/AS82MG)*2



## Tony Ray's AeroModel

### ***INDEX***

BEFORE YOU BEGIN-----	P.3
KIT INVENTORY-----	P.4~P.5
ASSEMBLY-Fuselage I-----	P.6~P.11
ASSEMBLY-Fuselage II-----	P.12~P.21
ASSEMBLY-Vertical & Horizontal Tail-----	P.22~P.25
ASSEMBLY-Wing structure-----	P.26~P.32
ASSEMBLY-Wing Covering-----	P.33~P.36
ASSEMBLY-Seats And Details-----	P.37~P.40
ASSEMBLY-Eletronics-----	P.41~P.42
BEFORE YOU FLY-----	P.42~P.43

# **BEFORE YOU BEGIN**

## **Attentions and Tips**

1. Read through the manual before you begin, so you will have an overall idea of what to do.
2. Check all parts. If you find any serious defects or missing parts, please contact your local dealer.
3. Please build your kit in strict accordance with the sequence of the user manual.
4. Pre-Sanding: Before removing any parts from the laser-cut plywood sheet, use a sanding block loaded with 250 - 400 grit sandpaper and lightly sand the back side of the sheet. Which can significantly reduce burn marks of the wood and make the parts match better
5. Before building the model part on drawings, It is recommended to cover a layer of kitchen cling film (polyethylene film) on the drawing. This way can prevent parts from sticking to the drawing and causing damage.
6. Parts Assembly: This product's tabs and notches interlock like a 3D puzzle. We strongly suggest that when fitting parts, you "dry fit" (use no glue) the parts together first. It is advised to work 1 - 2 steps ahead in the instructions, using this dry-fit technique. This allows the opportunity to inspect the fit and location of assembled components, and shows the benefits of our construction technique. As each successive part is added, it contributes to pulling the entire assembly square. Once you arrive at the end of a major assembly sequence, square your work on a flat work surface, and bond the dry-fit joints with glue. Using the dry-fit process, you'll be able to recover from a minor build mistake, and will ultimately end up with a square and true assembly.
7. This is a precision laser-cut kit. Our lasers cut to within 0.2mm in accuracy. Yet the wood stock supplied to us by the mill may vary in thickness by up to 0.2-0.3mm. This variance in the wood stock can cause some tabs and notches to fit very tightly. With this in mind, consider lightly sanding or lightly pinching a tight-fitting tab, rather than forcing the parts together. You may break some parts in assembly, but please don't worry, after the final covering work, it will not affect the strength and appearance of your model. You will end up with a circle and true airframe.

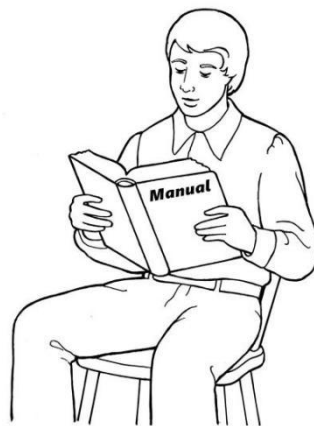

# KIT INVENTORY



<b>Sheet Wood Inventory</b>		
Item:	Mark	Quantity
2.0mm Plywood	A series:A1-A9	9
2.0mm Paulownia	A series:A10-A20	11
2.0mm Pine wood	A series:A21	1
3.0mm Plywood	B series:B1	1
3.0mm Paulownia	B series:B2-B3	2
3.0mm Balsa	B series:B4	1
1.5mm Balsa	C series:C1-C20	20
1.5mm Paulowniaa	C series:C21-C24	4
1.5mm Plywood	C series:C25	1
1.0mm Balsa	D series:D1	1
1.0mm Plywood	D series:D2-D3	2
5.0mm Balsa	E series:E1	1
2.0mm Balsa	F series:F1-F12	12
Aileron covering sheet	AL3	2

<b>Wood Strips Inventory*</b>	
3*3mm Balsa	6
6*6mm Balsa	4
2*6mm Pine	8
2*8mm Pine	12

TonyRay Aero Model Co.,Ltd

<b>Hardware*</b>	
<i>1. Hardware in Strips bag</i>	
PVC Tube (Outer diameter: 3mm, Inner diameter: 2mm)	2m
Steel push rod(Diameter1.2mm )	2+2
<i>2. Hardware in plastic bag</i>	
Laser cut Pvc sheet	1
Paper hinge	3
Leather strips	6
Rubber band	2
PU wheels	1
<i>3. Hardware in plastic box</i>	
M2 ball joint connector	4
M2 Steel push rod (Thread at both ends Length:25mm)	2
Steel wire adapter	2
Plastic collet	2
Rudder horn	4
M3*25 Screws	3
M3 Four Claws Nut	6
M2 Screw nut(black version)	4
M2 Screw nut	20
M2*20 Screws	4
M2*10 Screws	20
M2*8 Screws (Spacer Version)	16
Copper hinge	4
M1*3 Screws	40
Metal hook	2
M3 Flat end set screws	2
<i>5. Vacuum Formed Canopy</i>	
Canopy	2

<b>Paper parts</b>	
1:1 drawings	2

# ASSEMBLY-Fuselage I

Step1



Step2

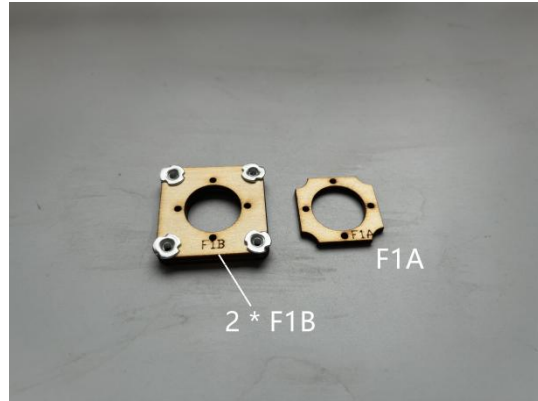

Step3

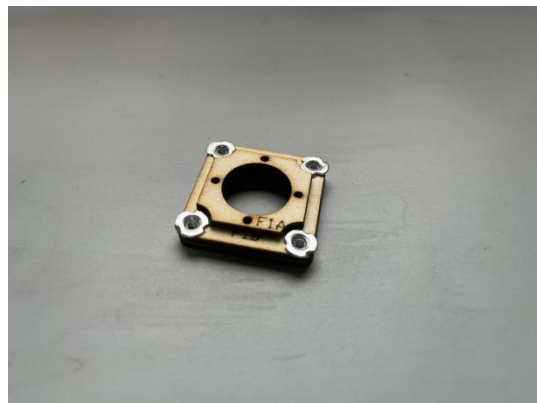

Step4



Step5

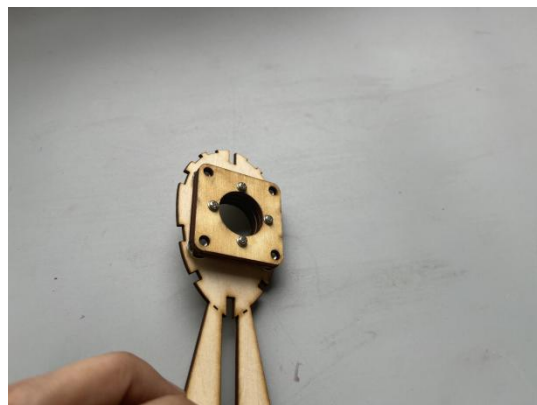

Step6



Step7

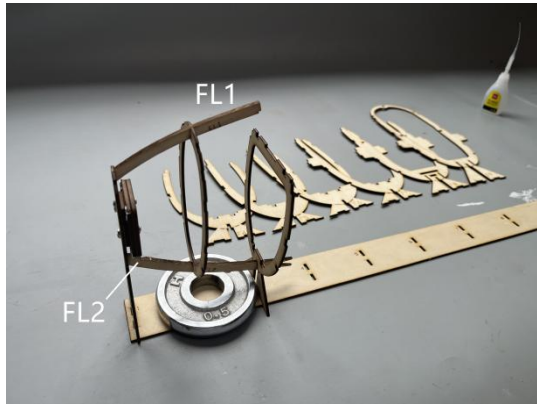

Step8

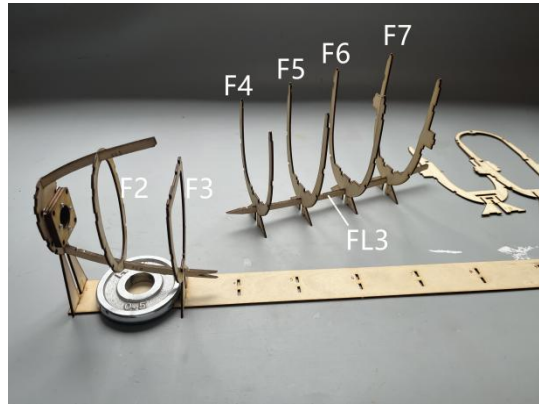

Step9

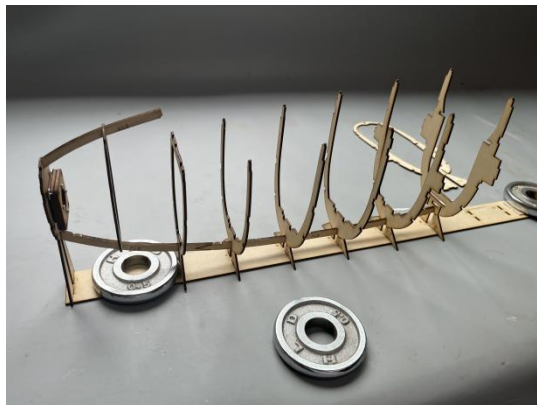

Step10

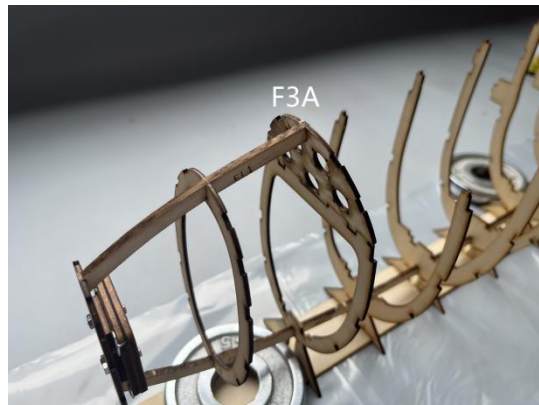

Step11

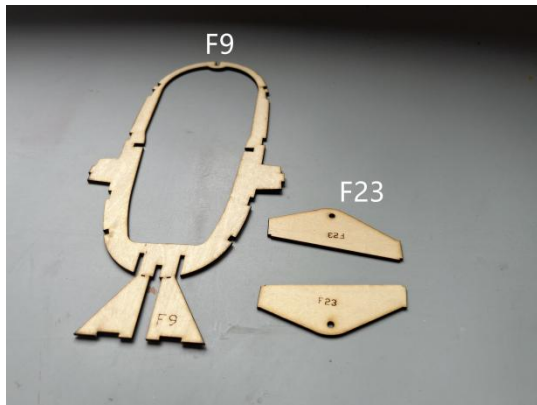

Step12

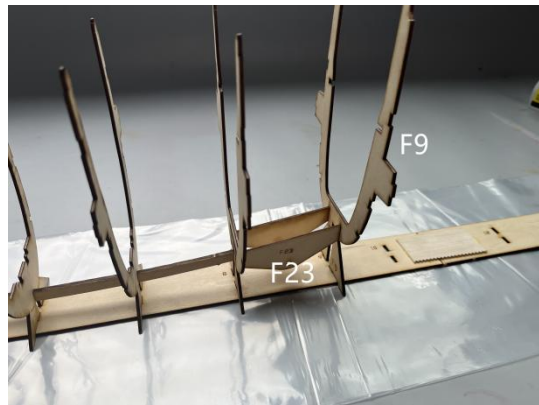

Step13



Step14

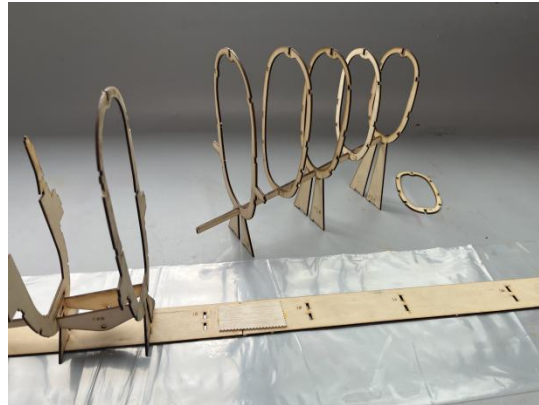

Step15

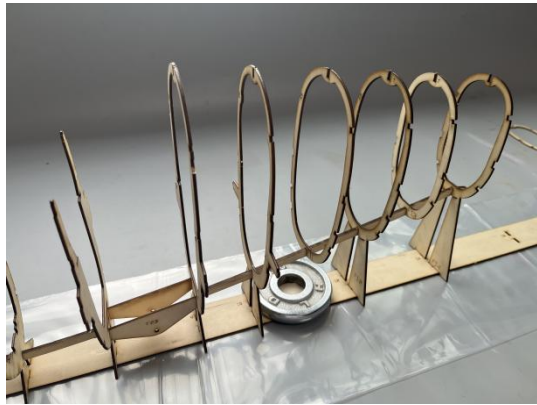

Step16

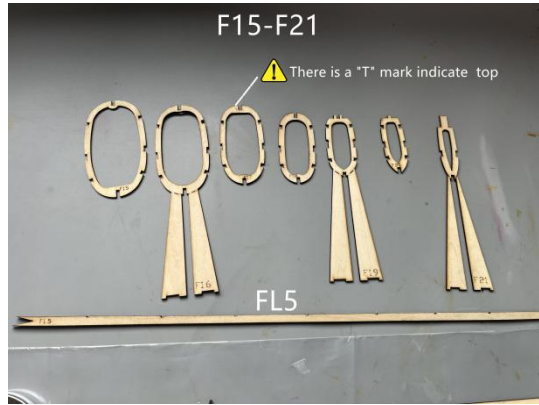

Step17

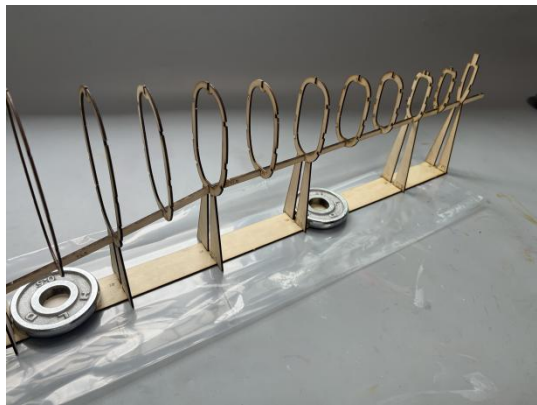

Step18

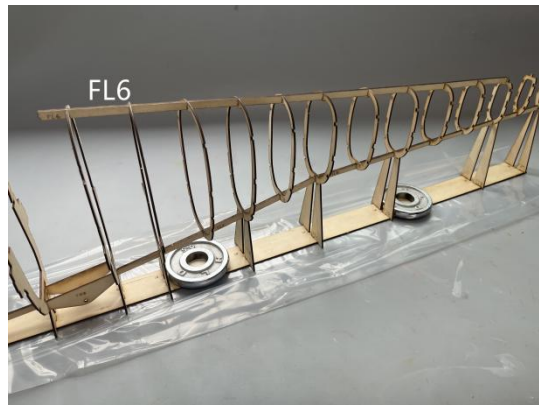

Step19

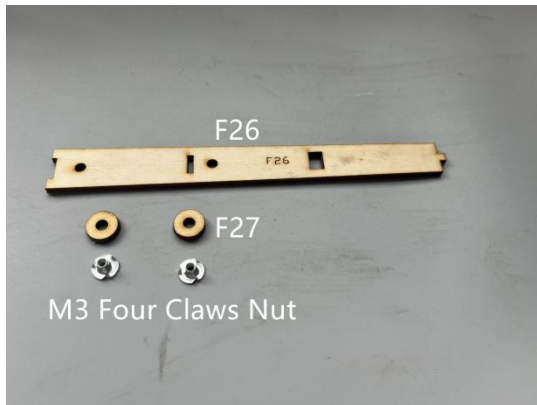

Step20



Step21



Step22

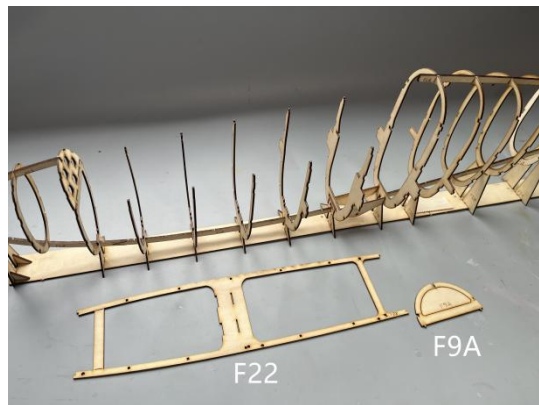



Step23

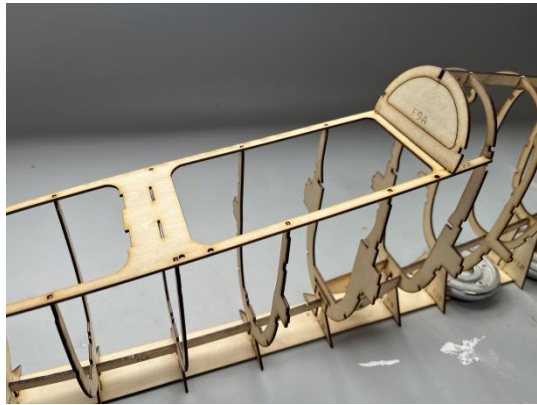

Step24

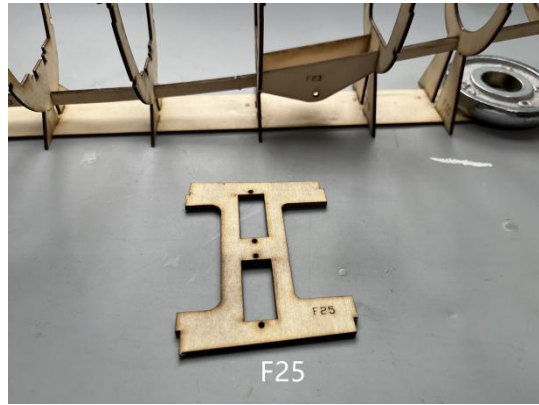

Step25



Step26

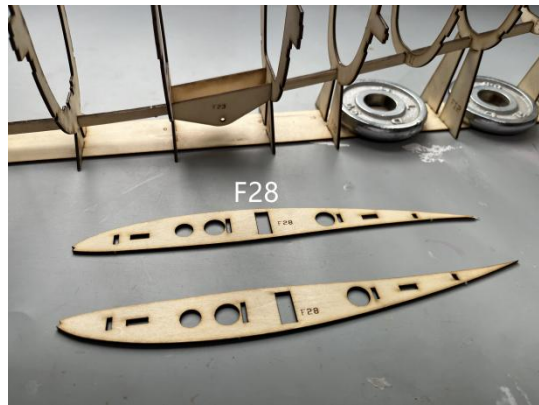

Step27

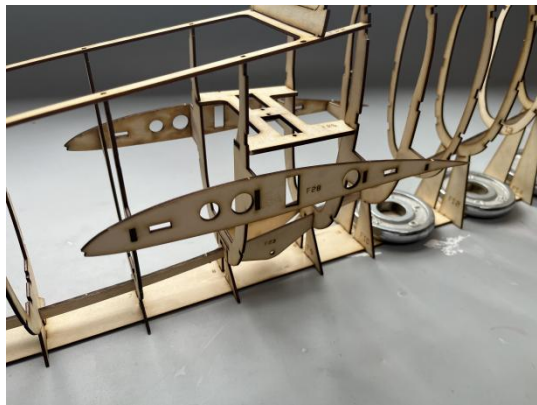

Step28

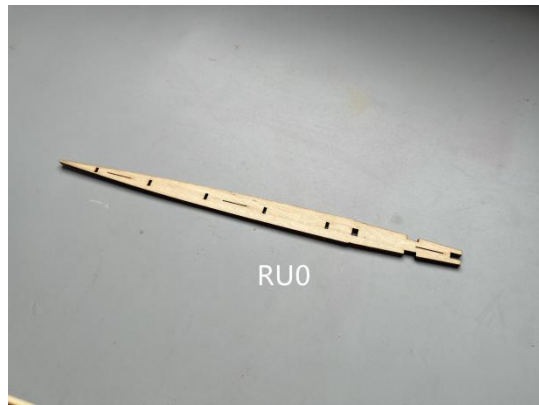

Step29

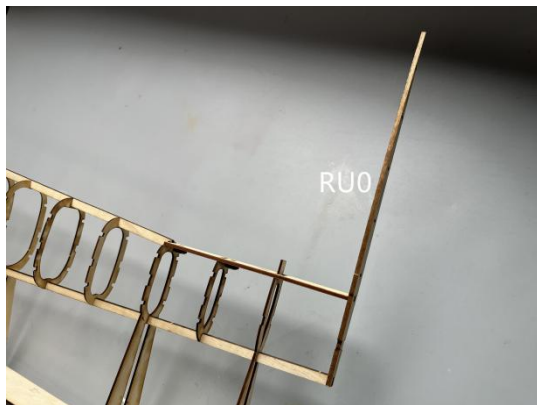

Step30

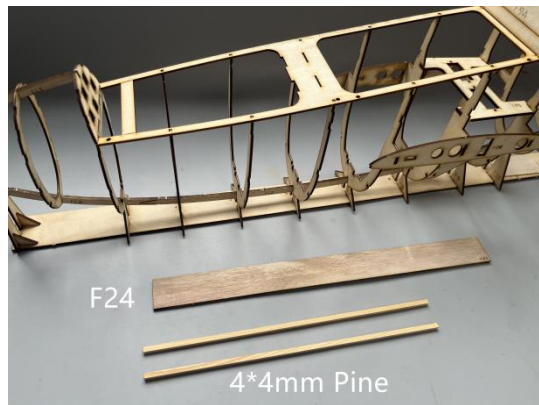

Step31

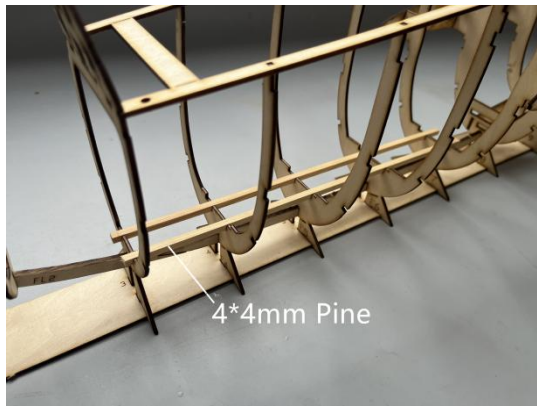

Step32

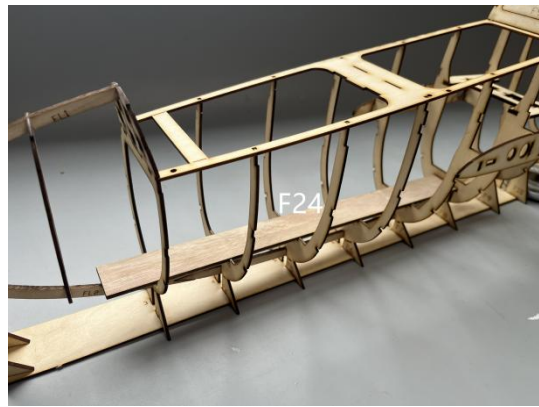

Step33

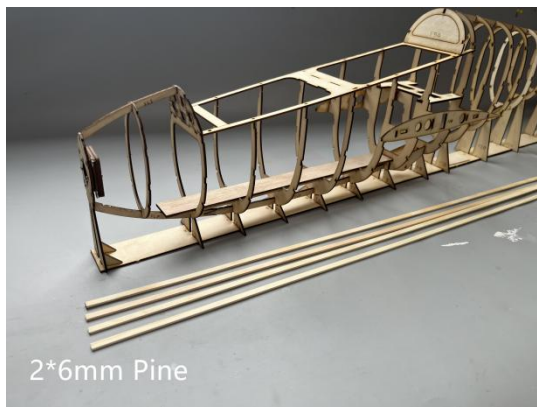

Step34



Step35

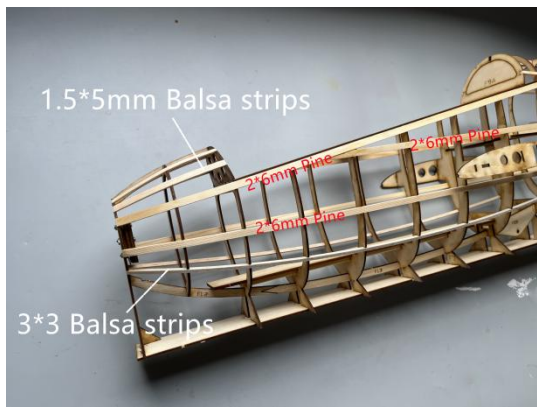

Step36



Step37

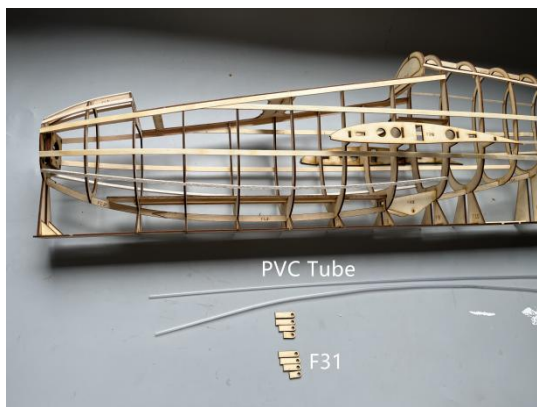

Step38

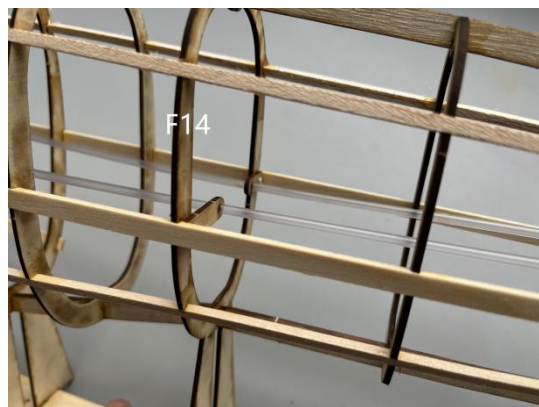

Step39



Step40

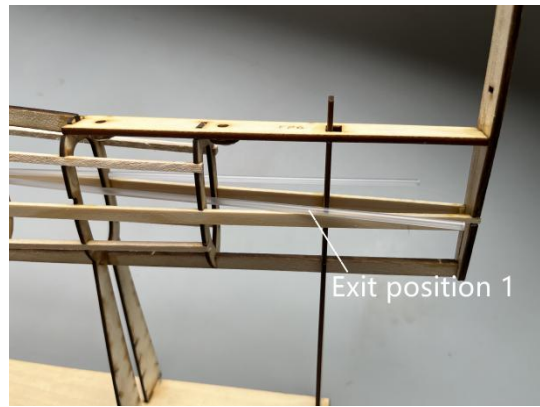

Step41

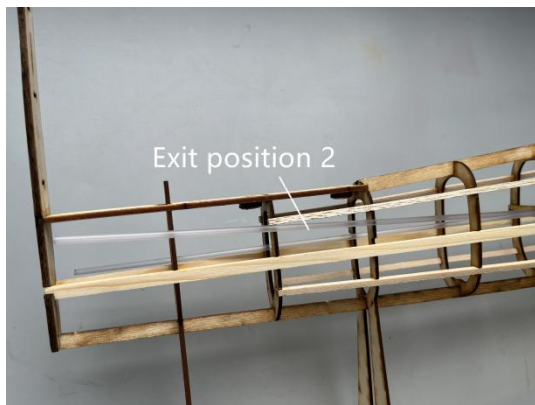

Step42

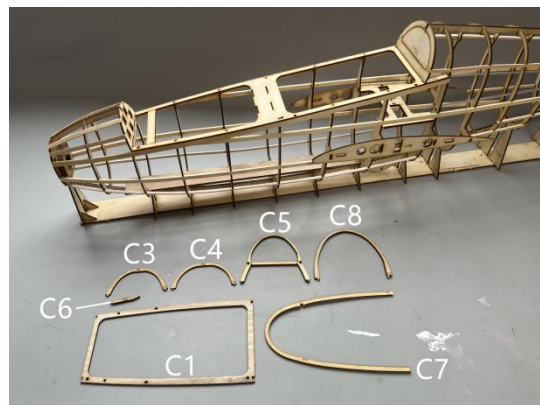

Step43

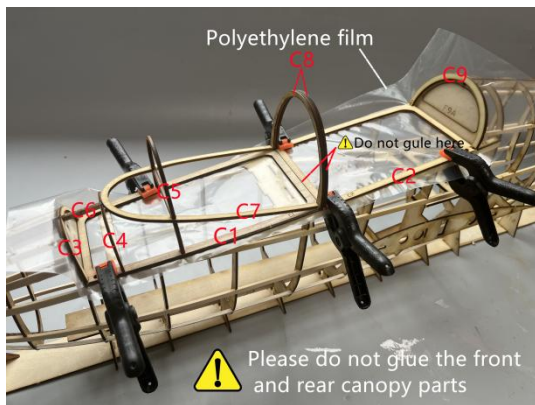

Step44

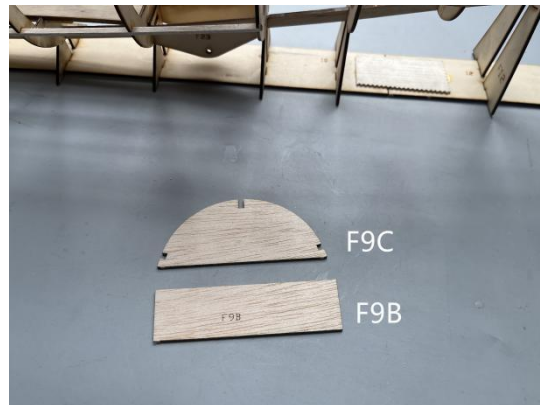

Step45

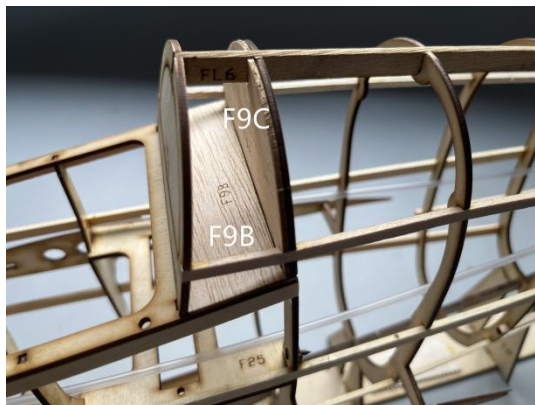

Step46



# ASSEMBLY-Fuselage II

Step1

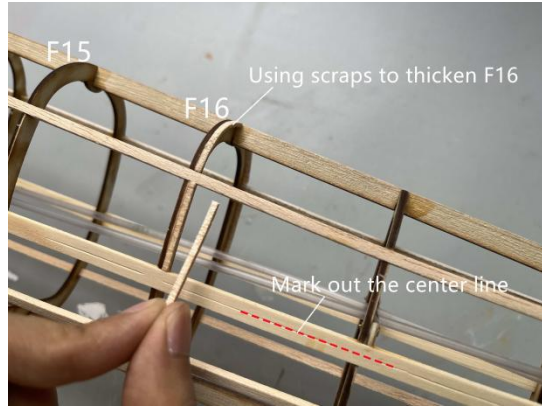

Step2

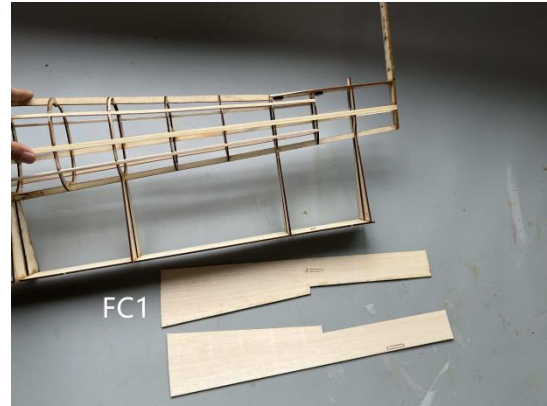

Step3



Step4



Step5

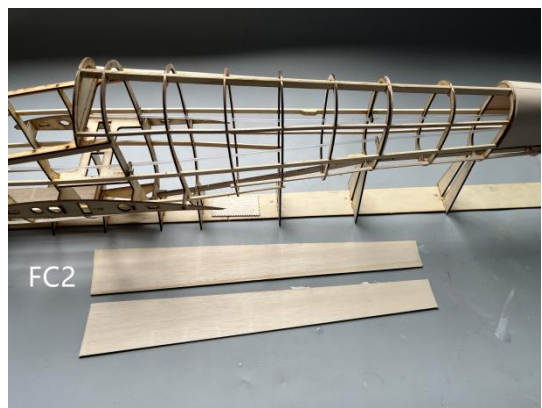

Step6

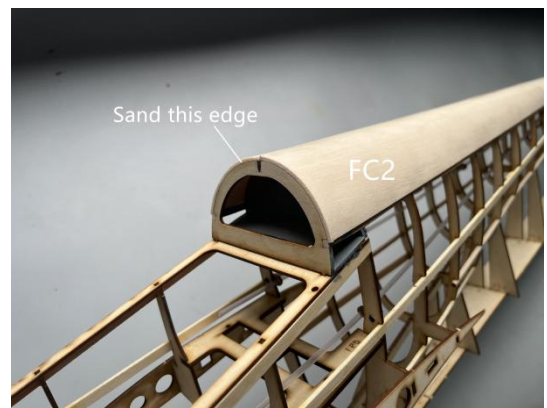

Step7



Step8

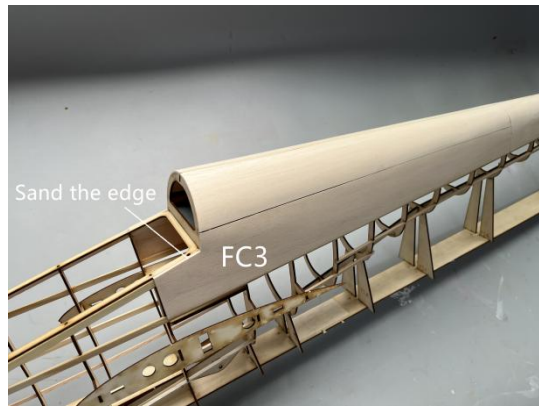

Step9

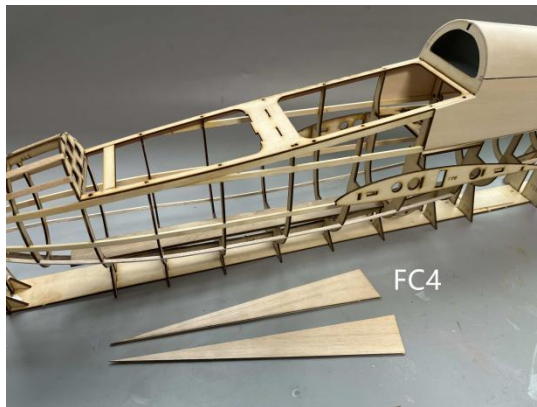

Step10

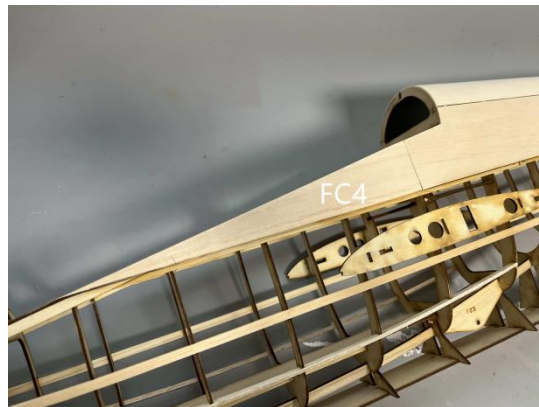

Step11



Step12

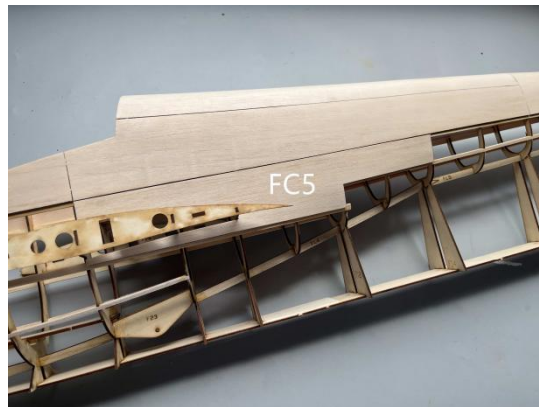

Step13

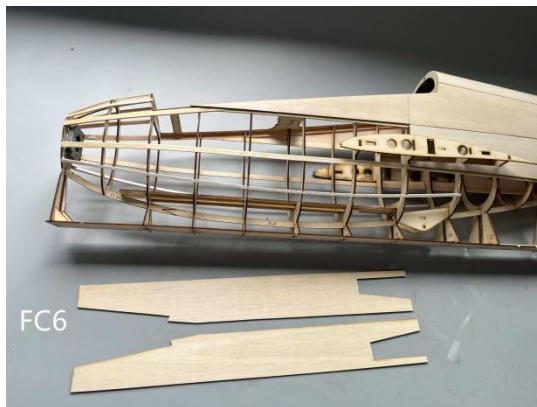

Step14



Step15

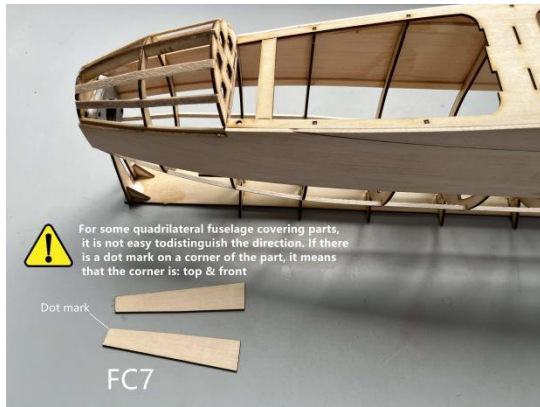

Step16

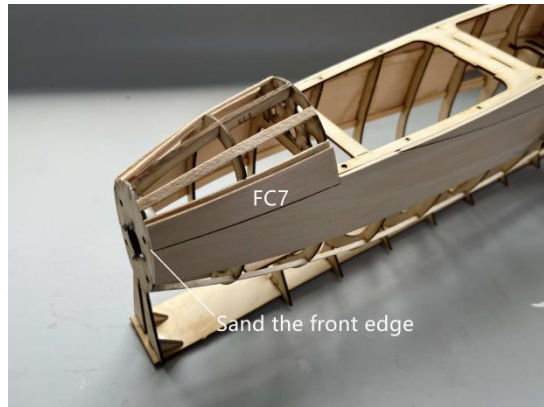

Step17

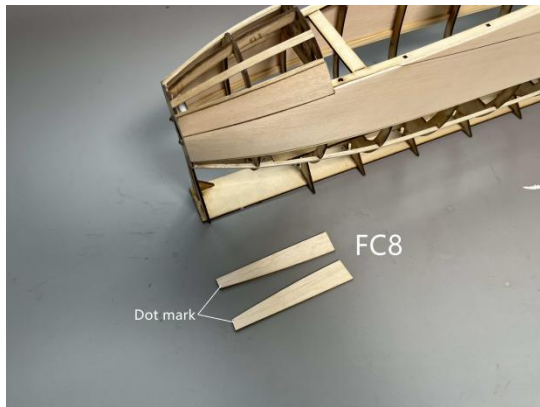

Step18

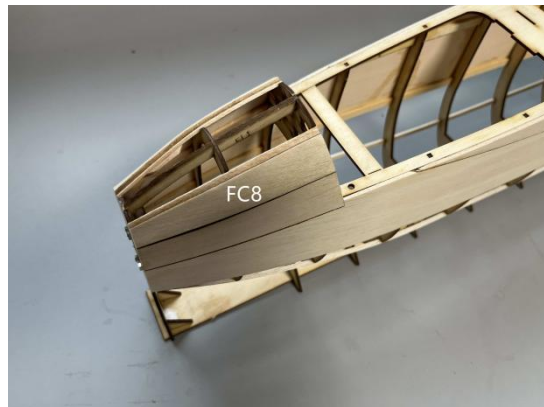

Step19

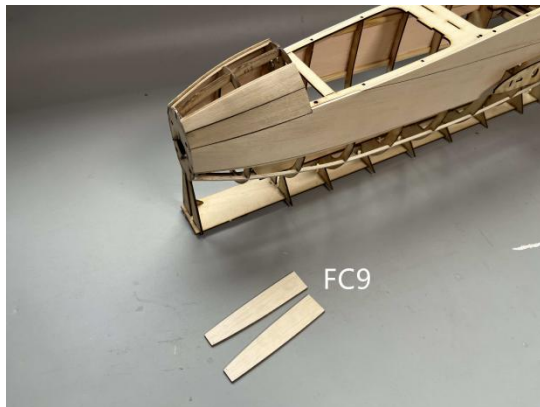

Step20

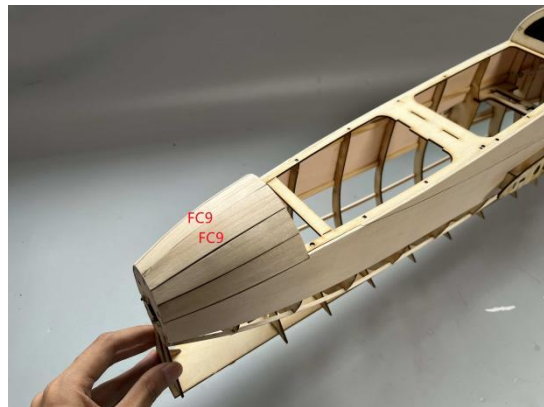

Step21

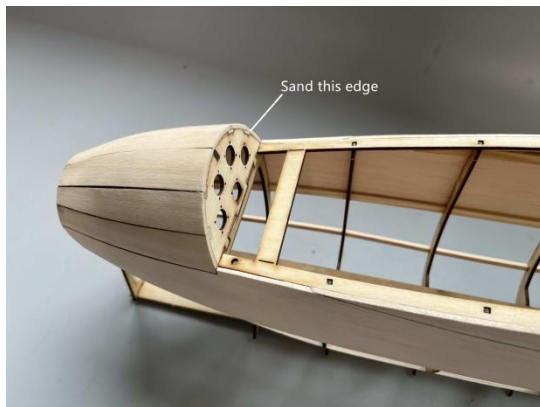

Step22



Step23

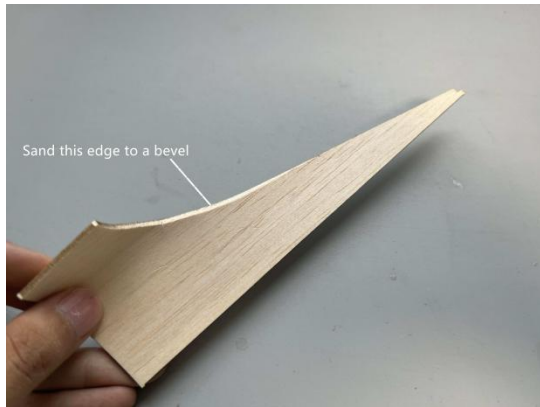

Step24



Step25



Step26

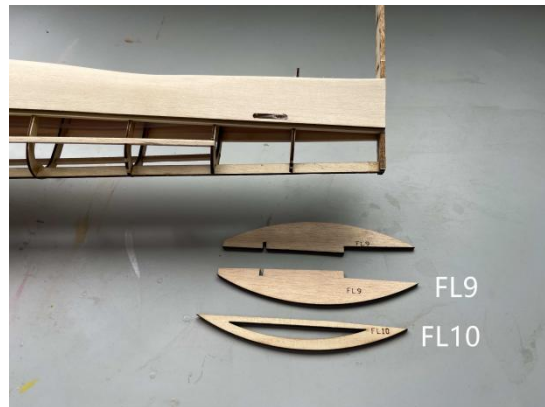

Step27

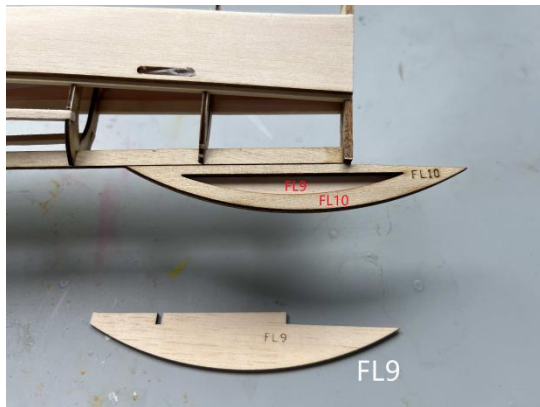

Step28



Step29

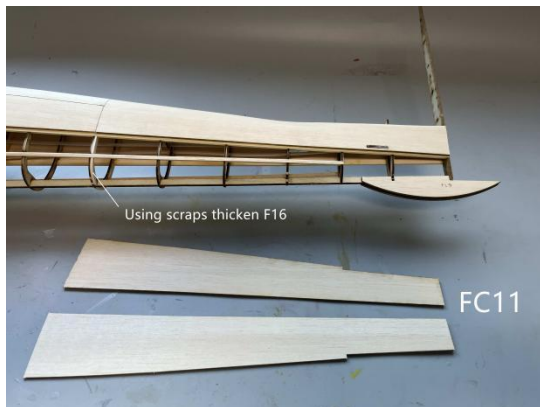

Step30

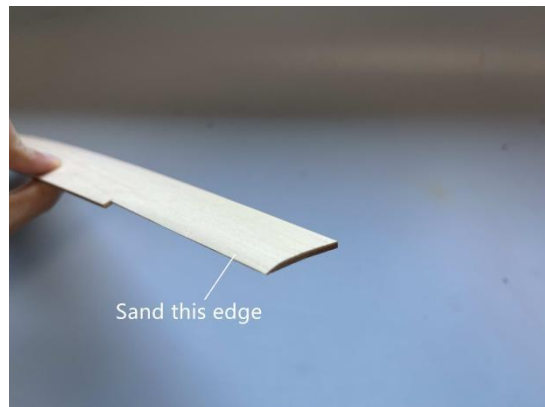

Step31

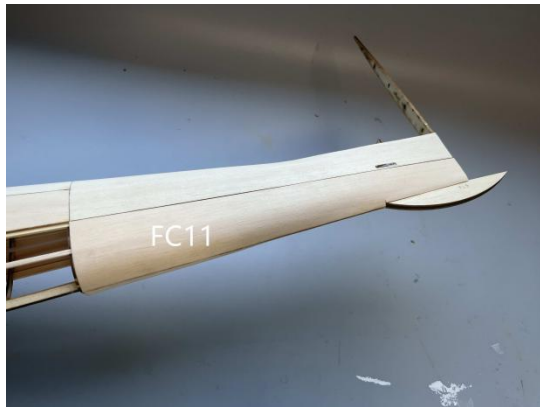

Step32

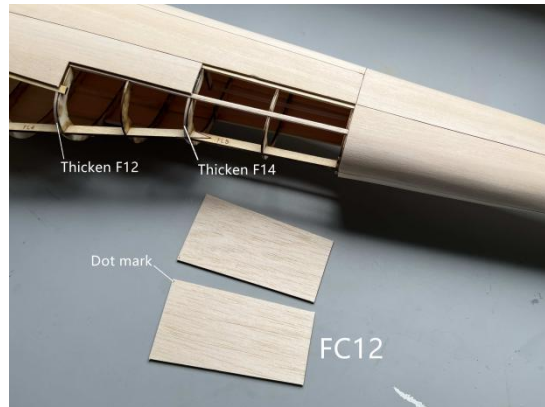

Step33



Step34

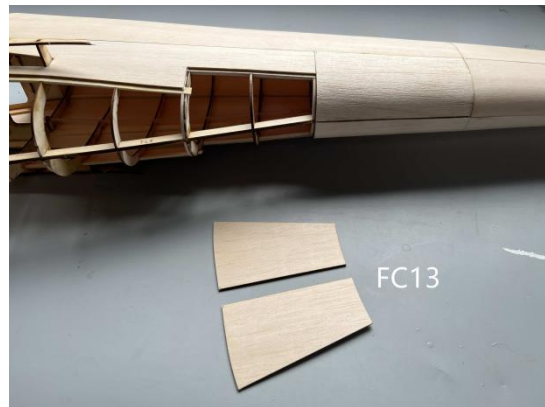

Step35



Step36

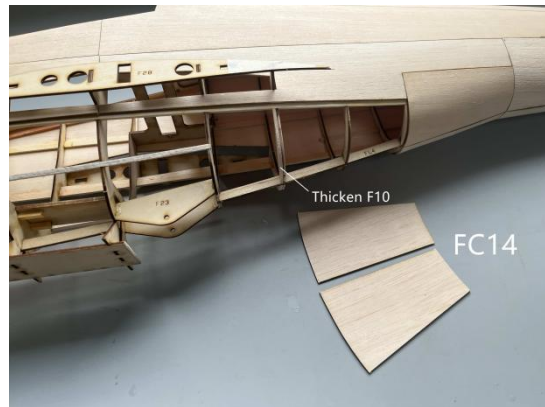

Step37



Step38

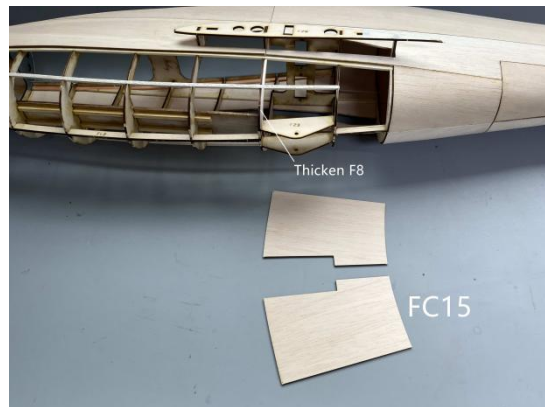



Step39



Step40



Step41

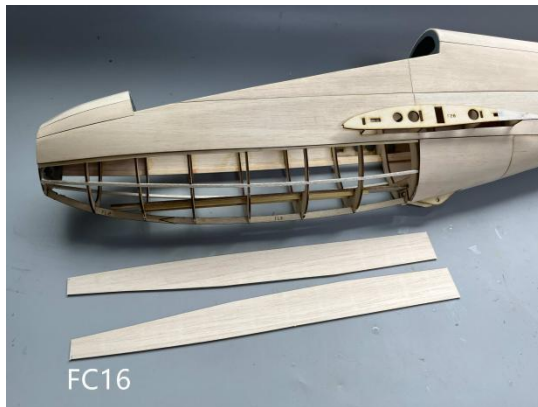

Step42



Step43

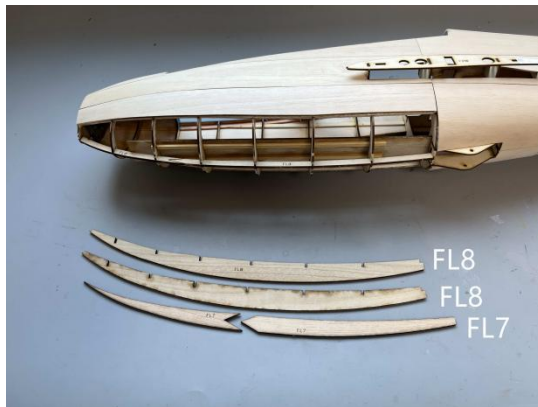

Step44

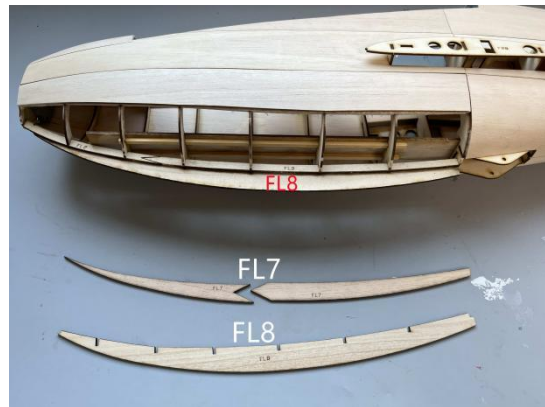

Step45



Step46



Step47

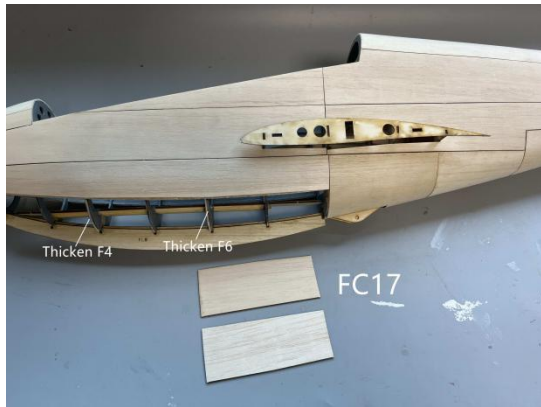

Step48



Step49



Step50



Step51



Step52

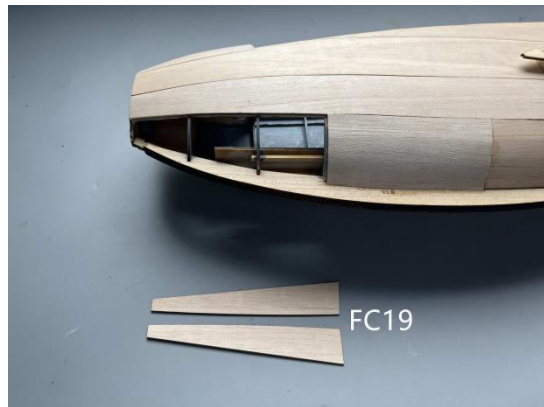

Step53



Step54



Step55



Step56

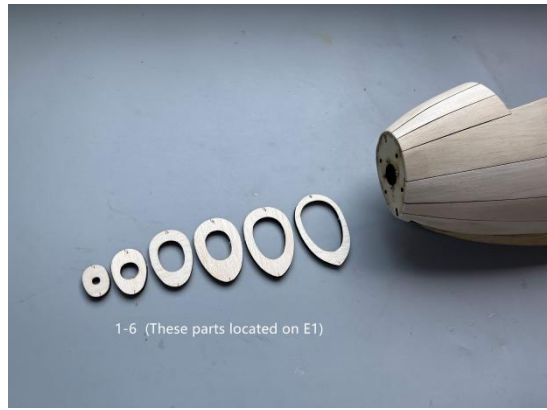

Step57

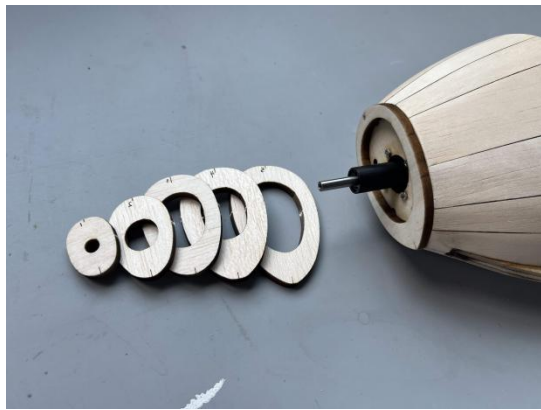

Step58

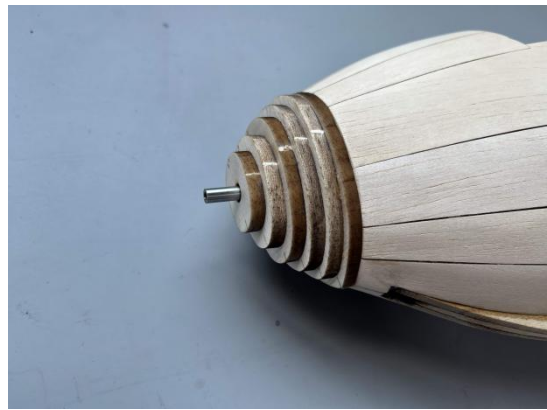

Step59



Step60



Step61

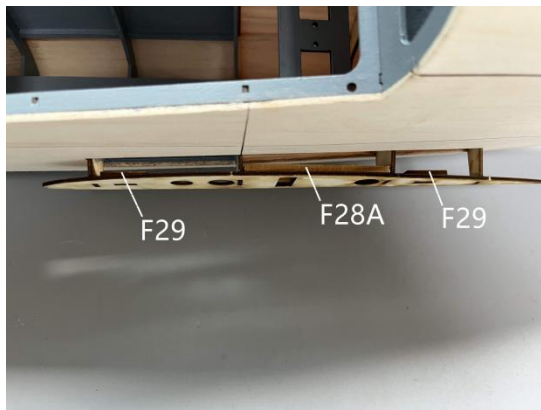

Step62



Step63



Step64

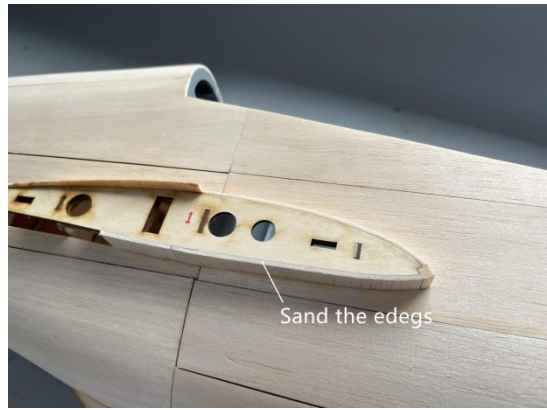

Step65

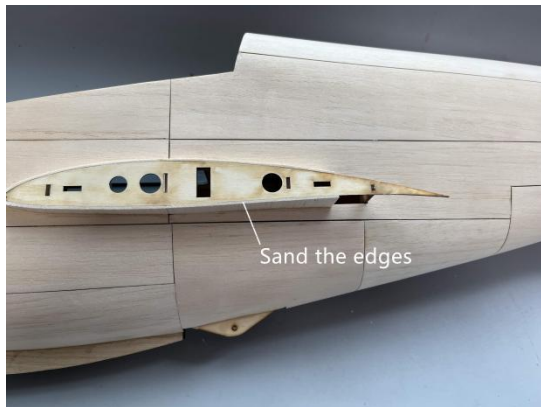

Step66



Step67

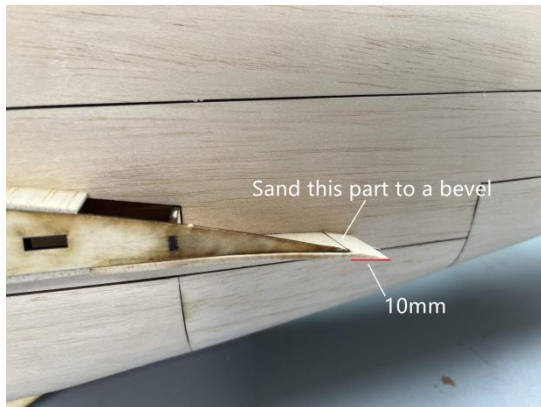

Step68



Step69



Step70



Step71

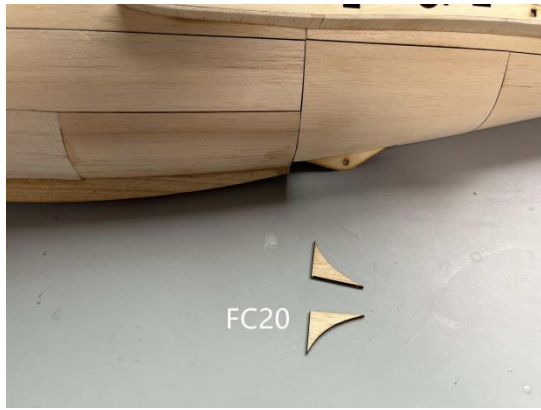

Step72

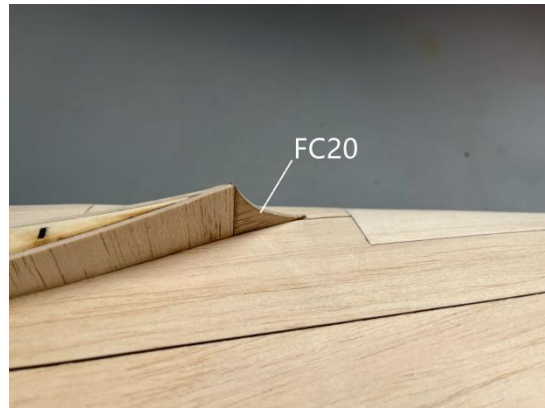

**Builder's note:**

# ASSEMBLY-Vertical & Horizontal Tail

Step1

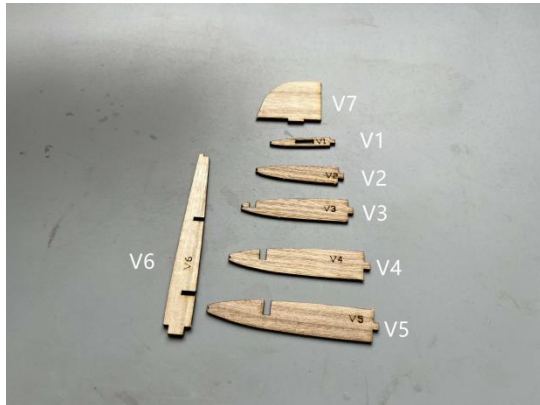

Step2

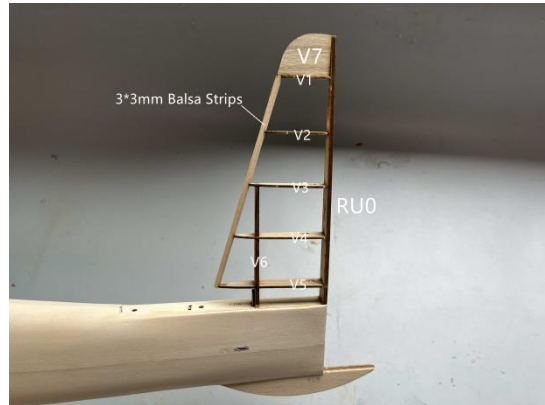

Step3

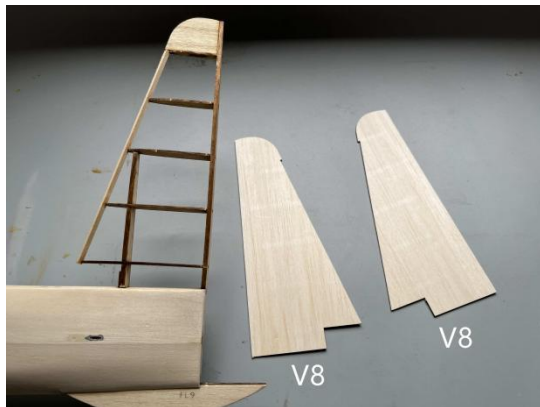

Step4

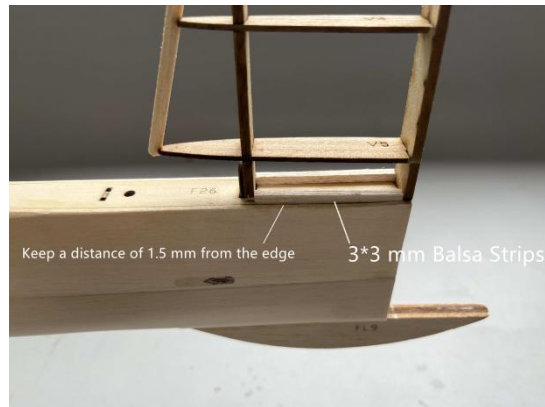

Step5

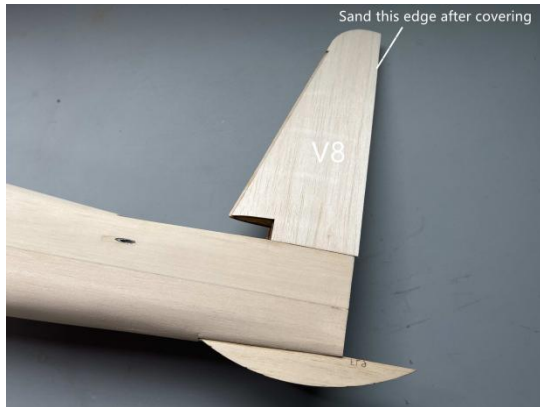

Step6

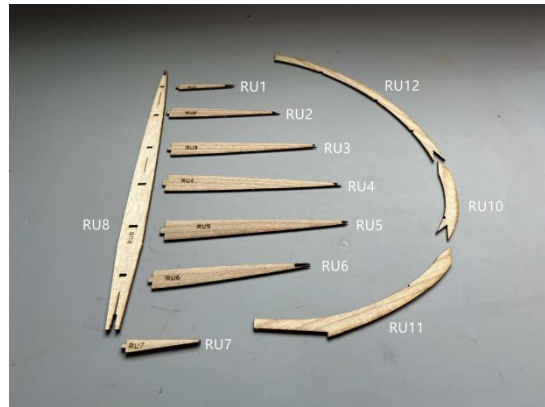

Step7



Step8



Step9



Step10

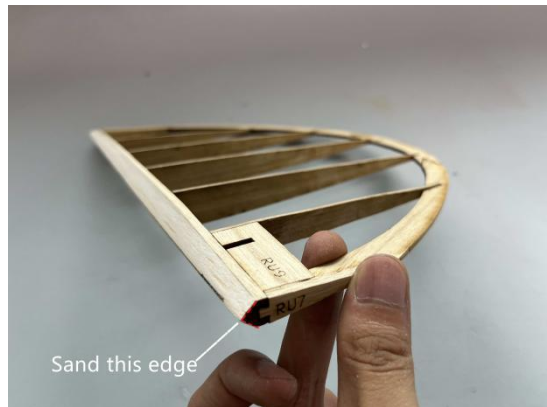

Step11



Step12

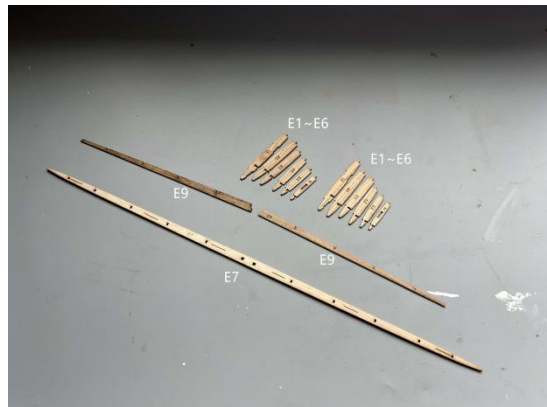

Step13

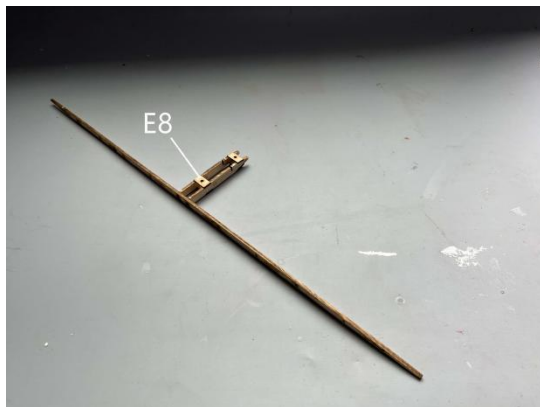

Step14



Step15



Step16

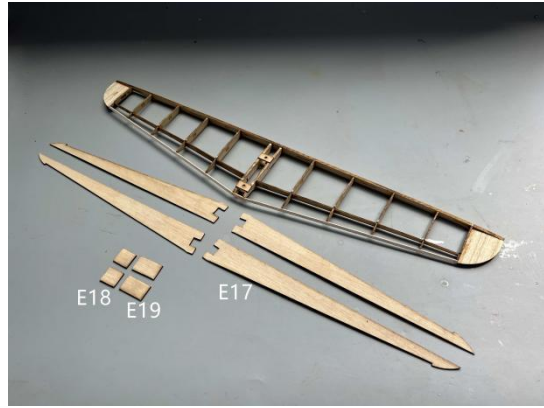

Step17



Step18



Step19

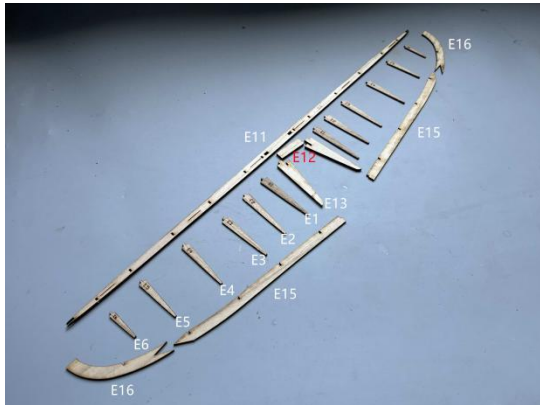

Step20

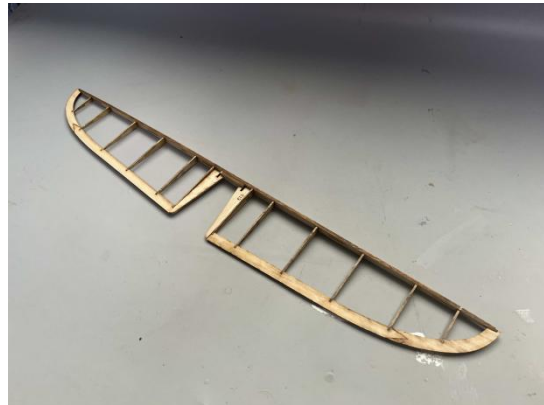

Step21

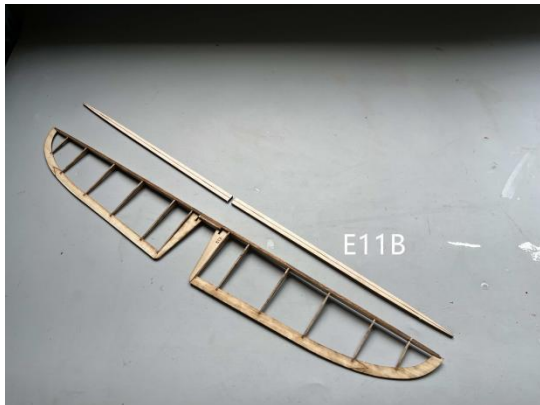

Step22





Step23



Step24

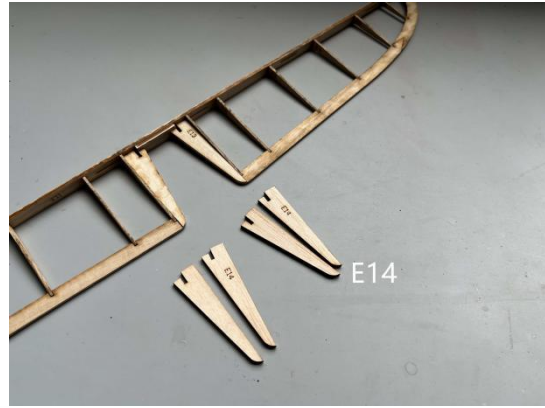

Step25

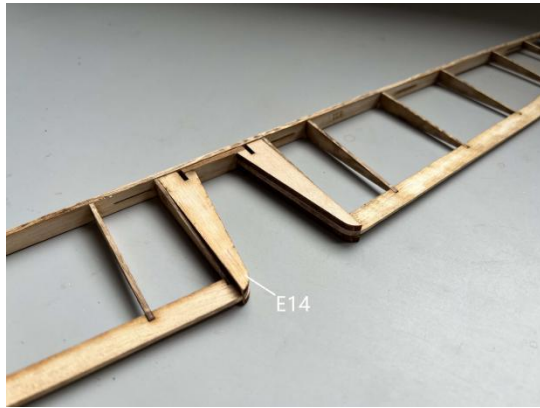

Step26

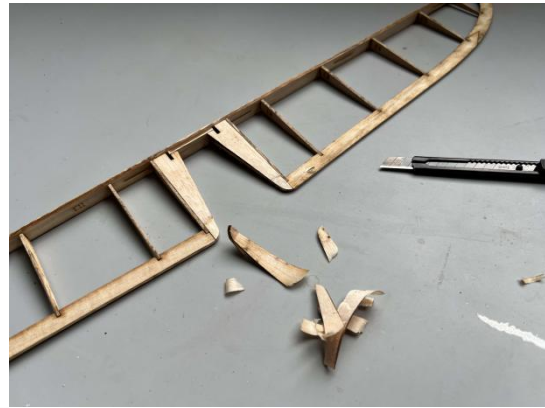

Step27

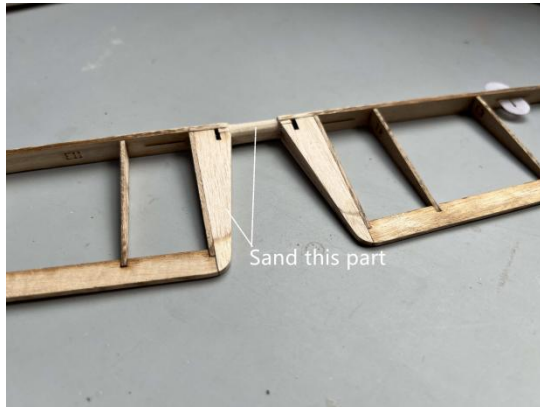

Step28

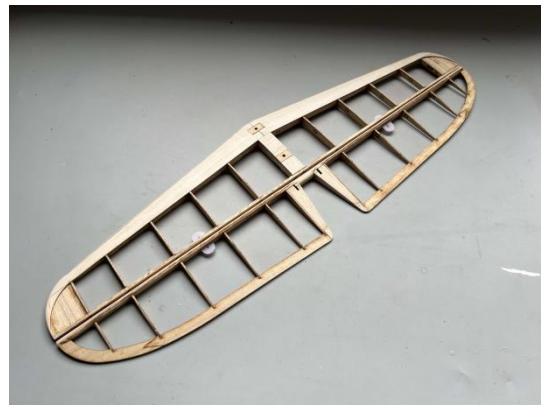

**Builder's note:**

# ASSEMBLY-Wing Structure

Step1

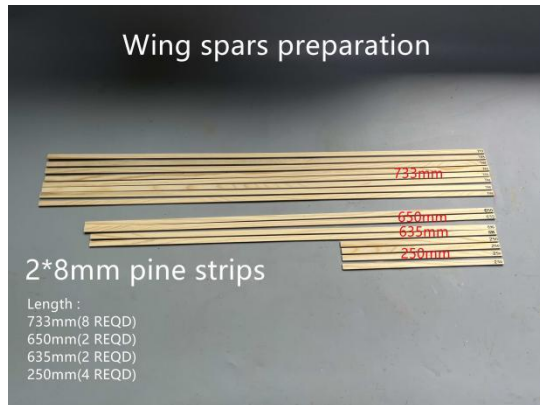

Step2



Step3



Step4



Step5

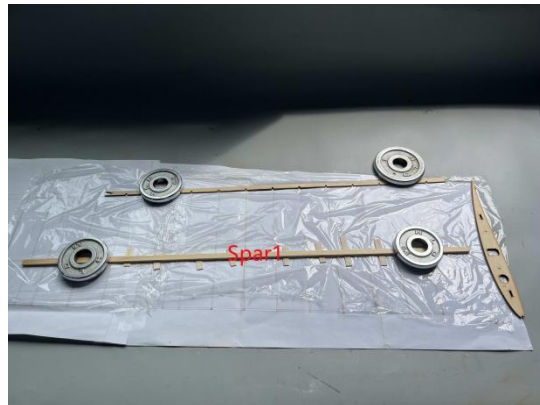

Step6

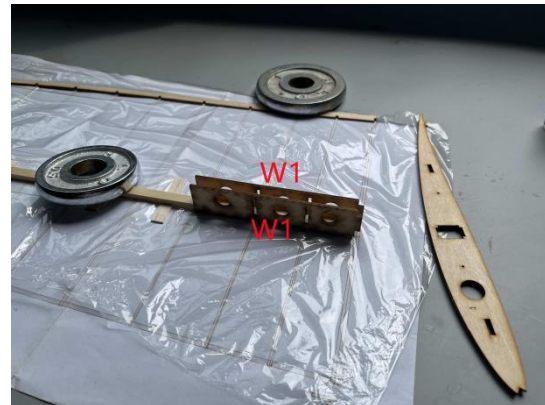

Step7



Step8



Step9



Step10



Step11



Step12



Step13

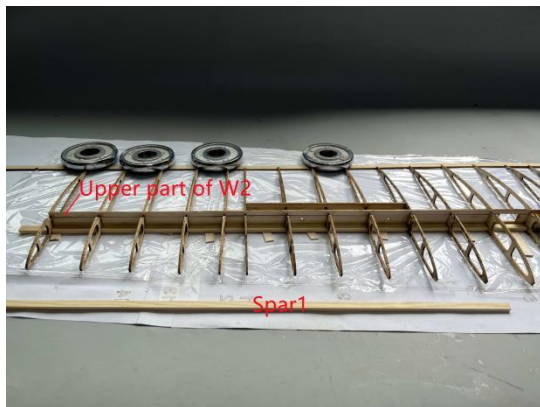

Step14



Step15

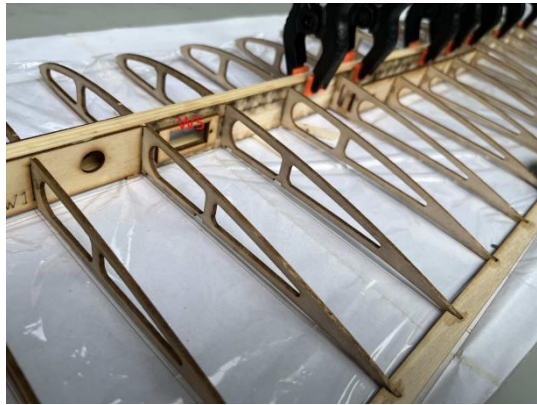

Step16

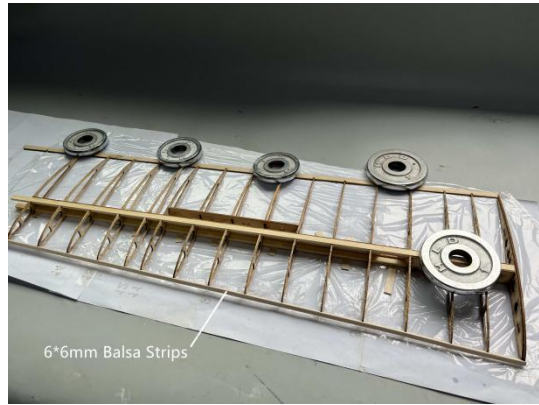

Step17

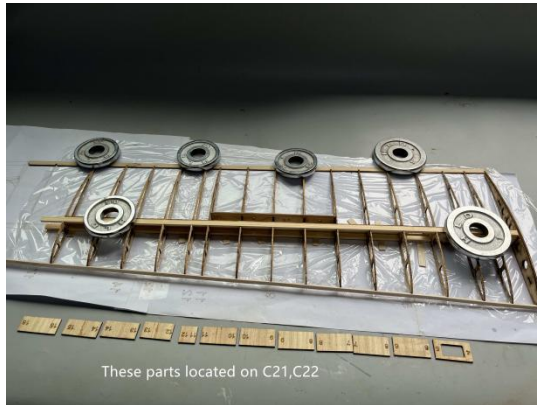

Step18

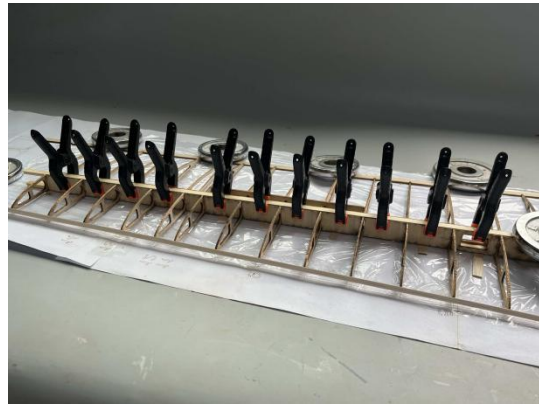

Step19



Step20

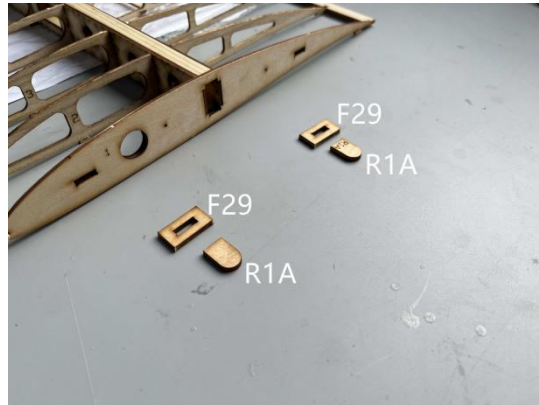

Step21

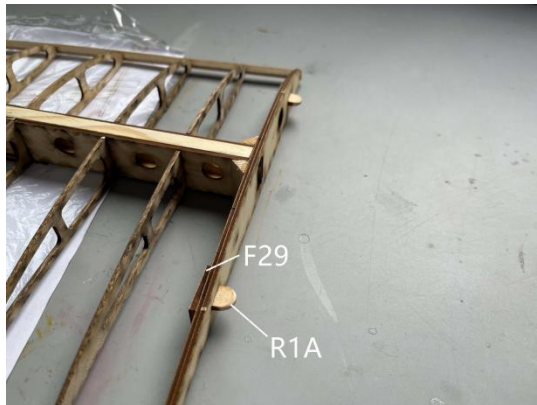

Step22

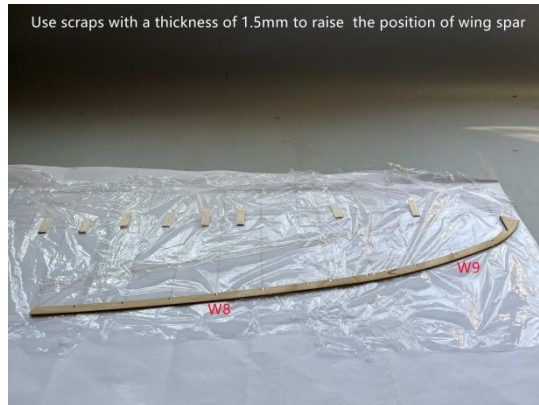

Step23



Step24

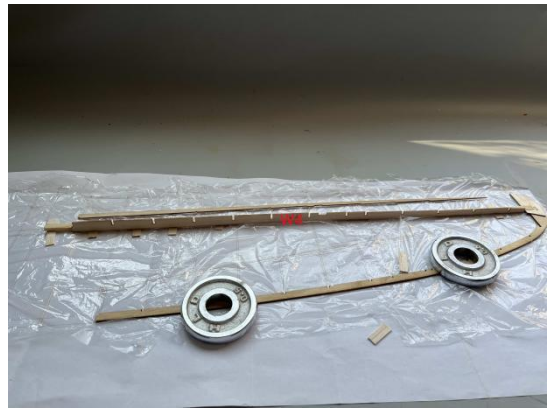

Step25



Step26



Step27



Step28



Step29



Step30



Step31

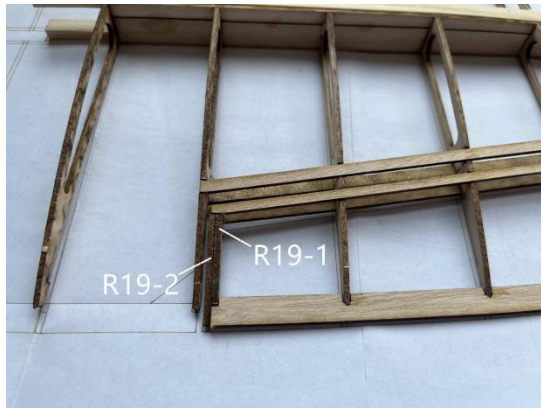

Step32

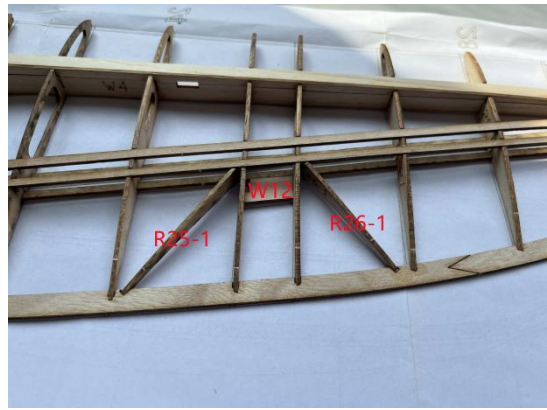

Step33



Step34

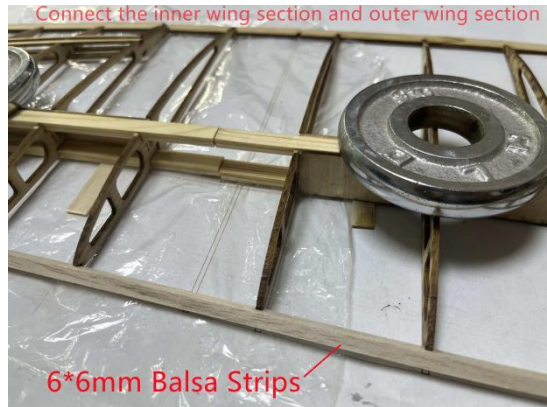

Step35



Step36



Step37

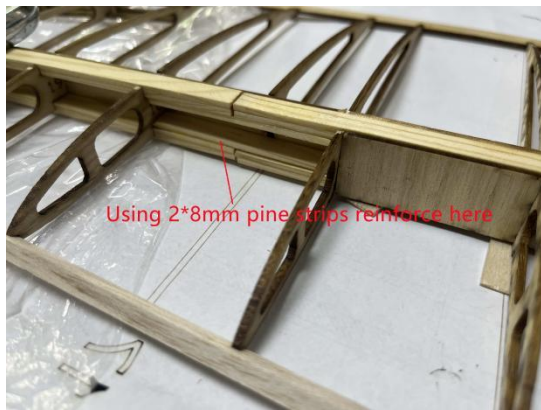

Step38

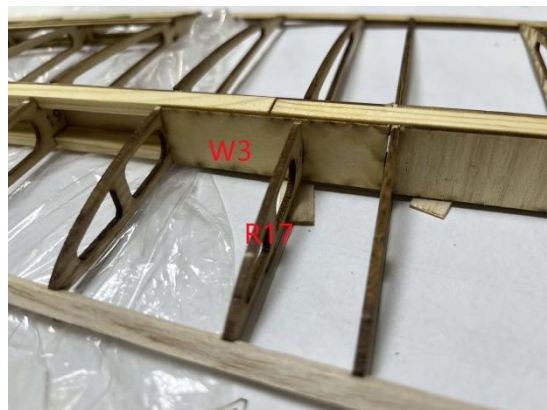

Step39



Step40

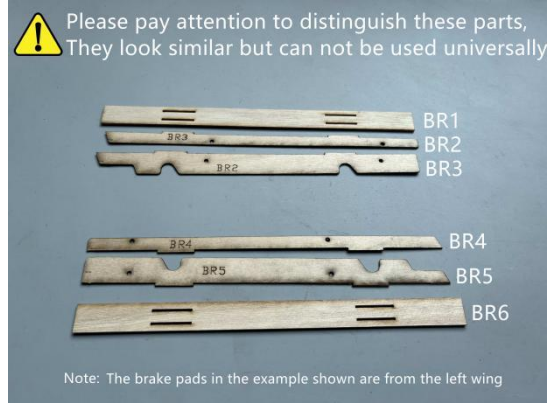

Step41

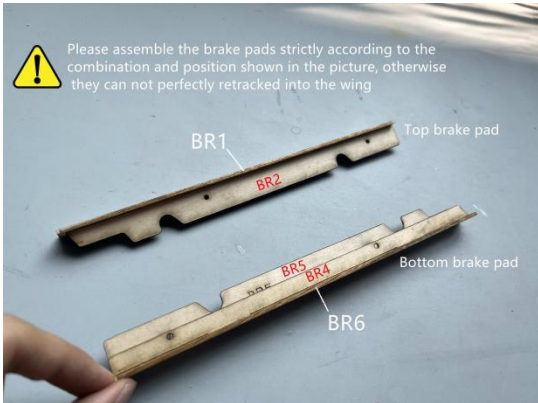

Step42

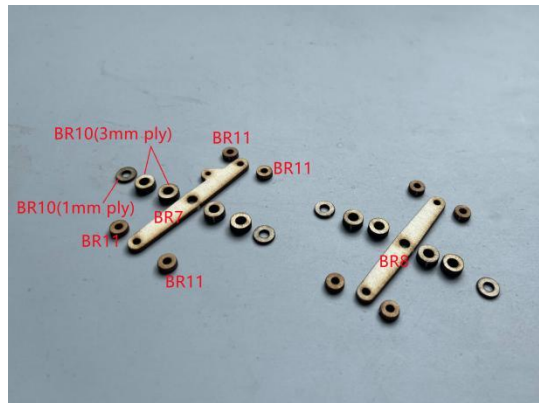

Step43



Step44

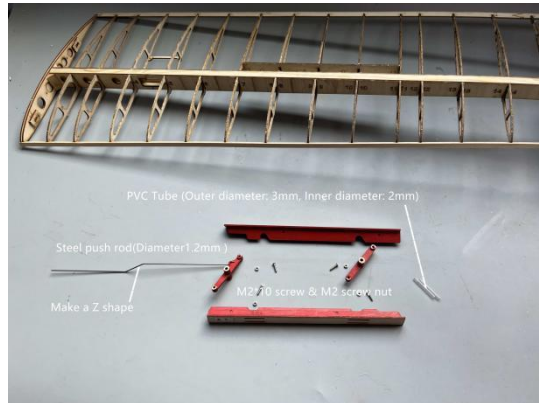

Step45

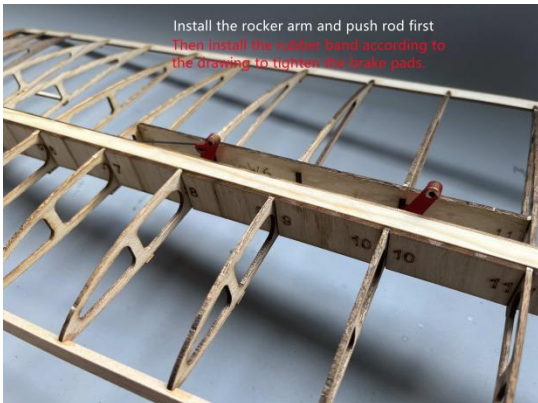

Step46

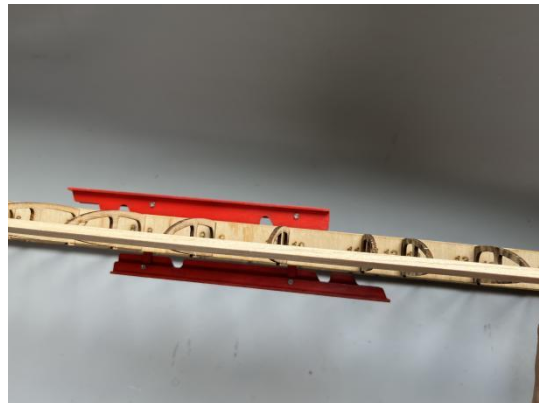

Step47

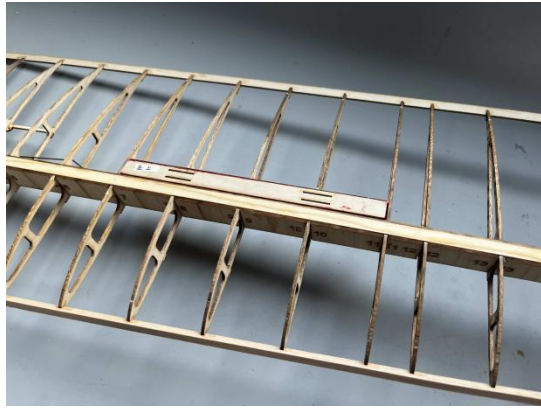

Step48



Step49



**Builder's note:**



# ASSEMBLY-Wing Covering

Step1

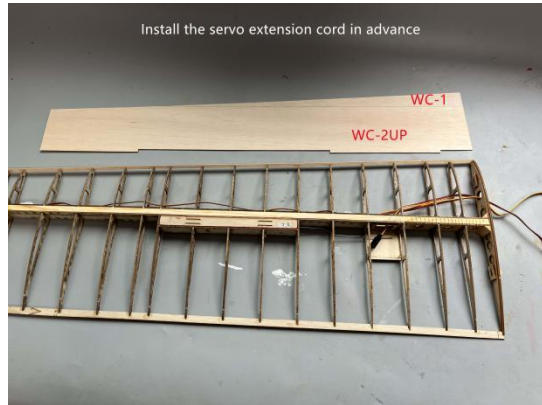

Step2

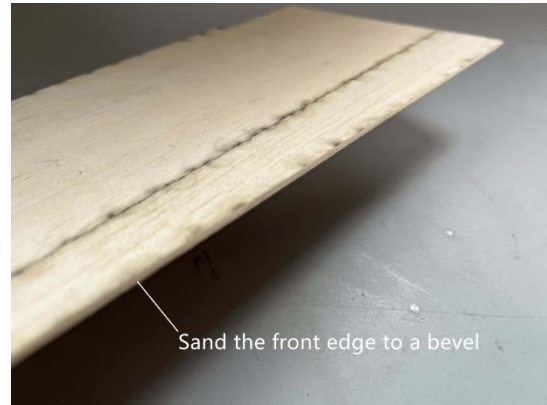

Step3



Step4



Step5

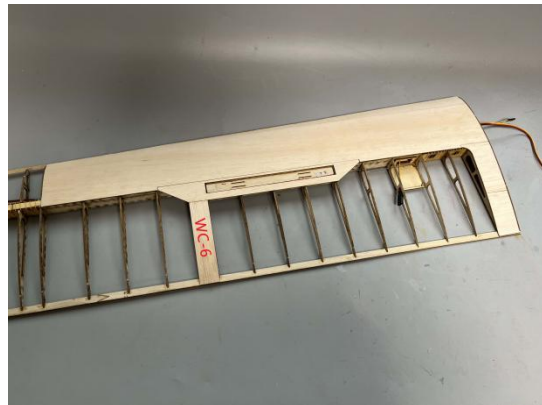

Step6



Step7

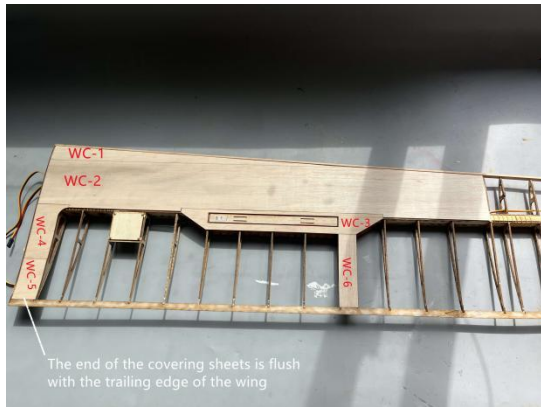

Step8

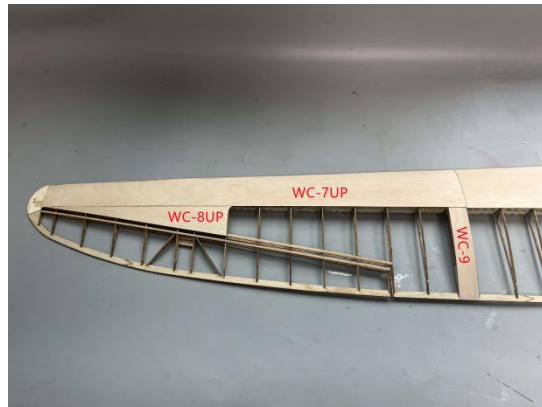

Step9

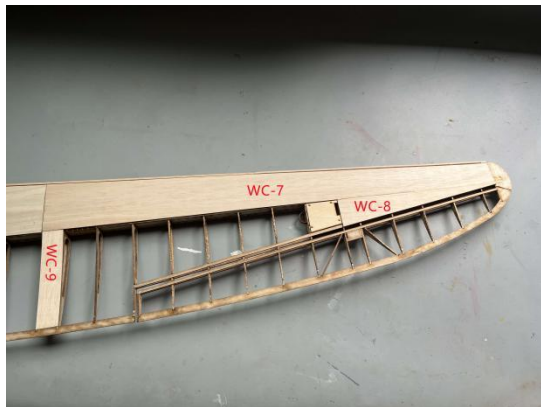

Step10



Step11



Step12

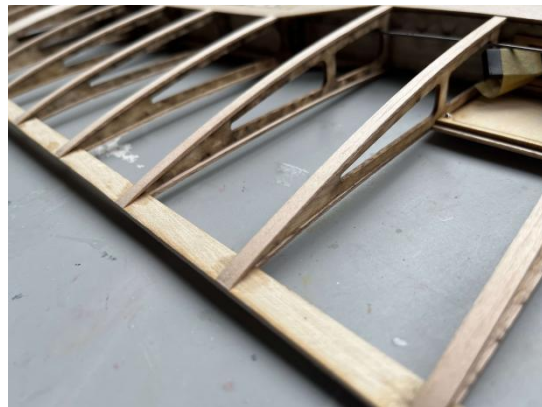

Step13



Step14

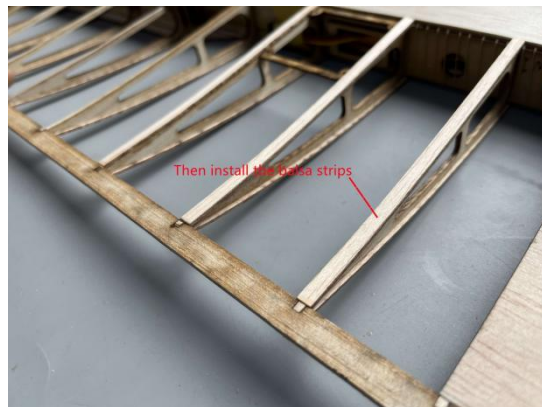

Step15

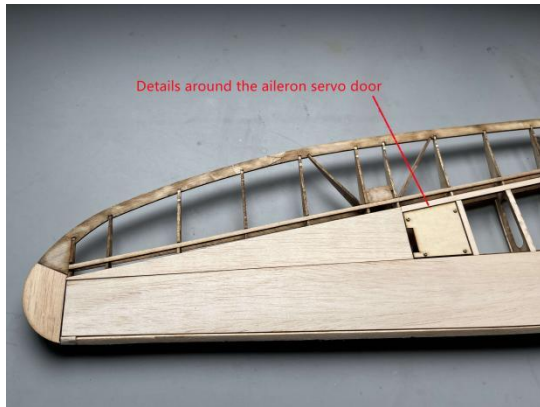

Step16



Step17



Step18



Step19



Step20



Step21



Step22

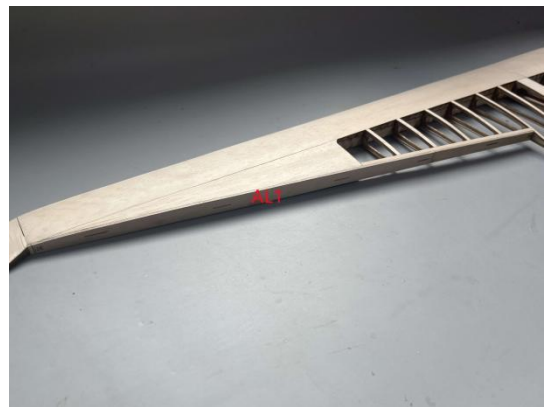

Step23

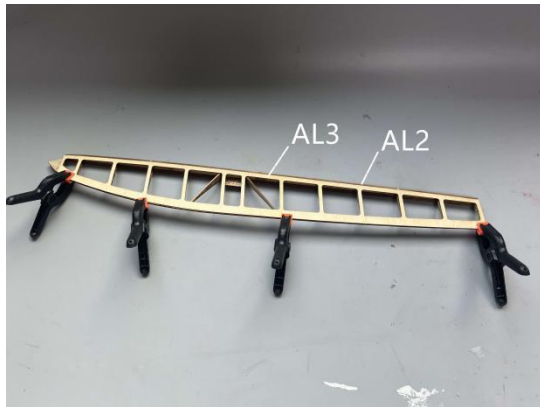

Step24

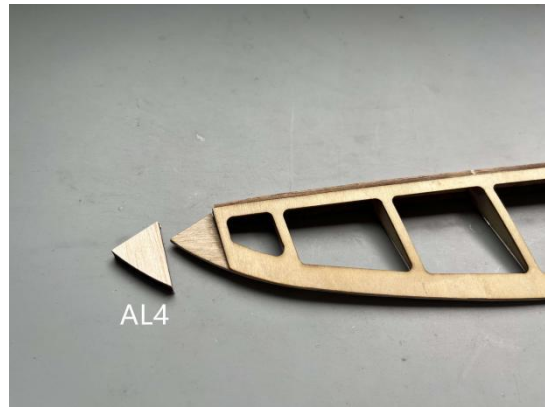

Step25



Step26

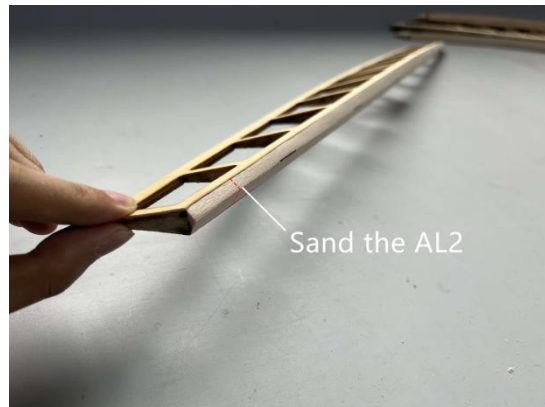

Step27

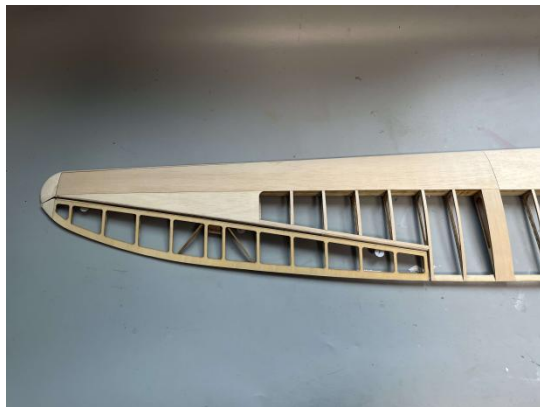

**Builder's note:**

# ASSEMBLY-Seats And Details

Step1



Step2

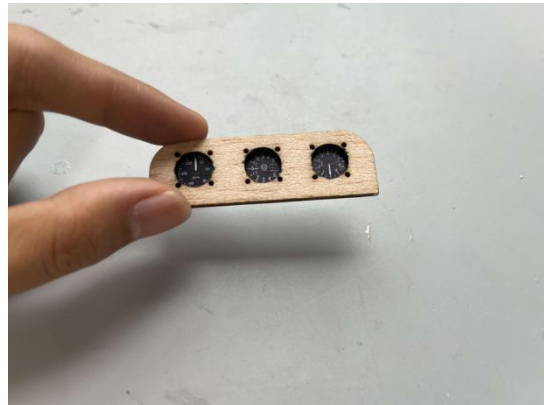

Step3

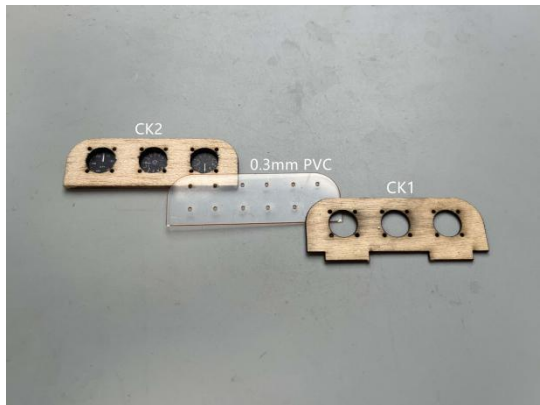

Step4



Step5



Step6



Step7



Step8



Step9

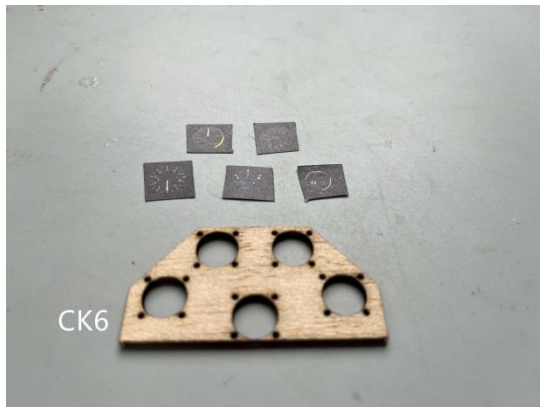

Step10

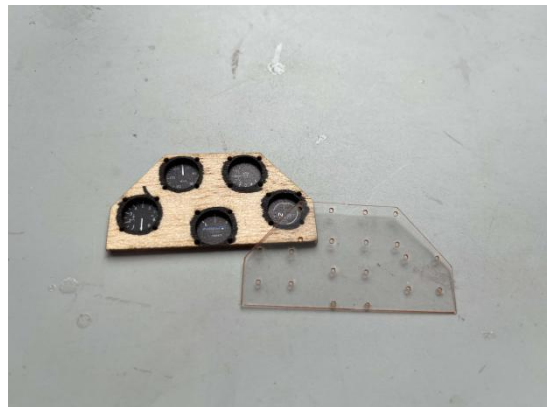

Step11



Step12



Step13



Step14

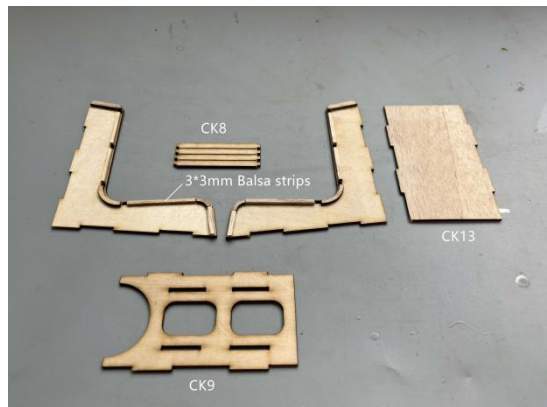

Step15



Step16



Step17

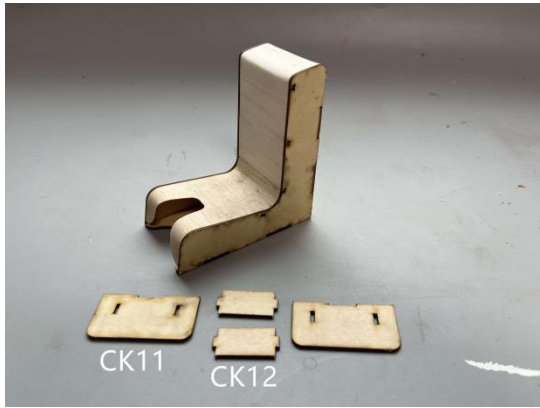

Step18



Step19

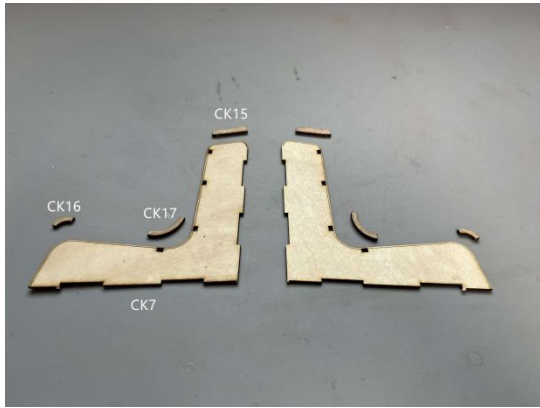

Step20

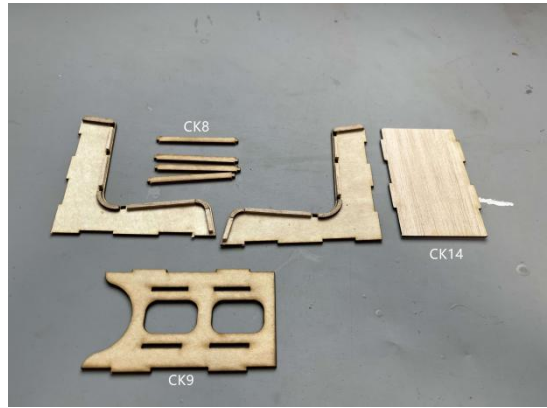

Step21



Step22



Step23



Step24



Step25

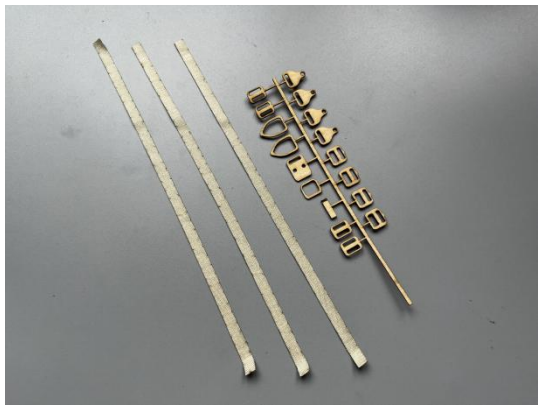

Step26

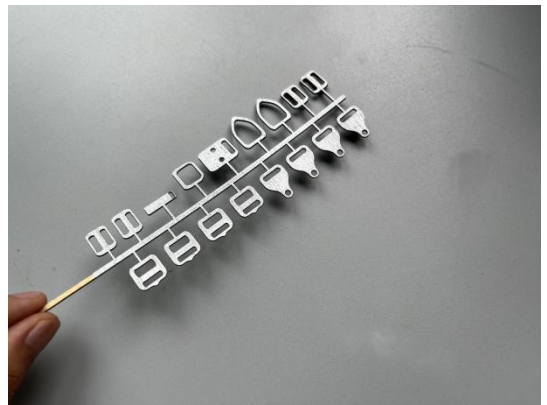

Step27

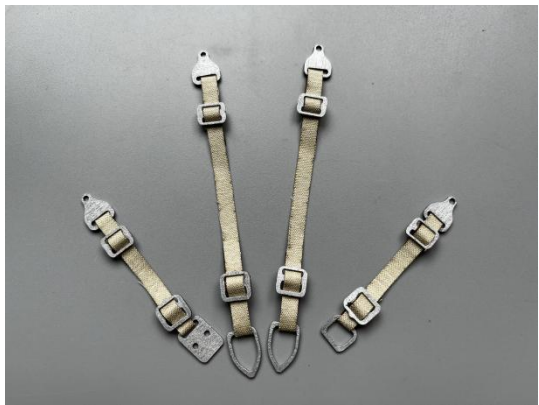

Step28



Step29



**Builder's note:**



# **ASSEMBLY-Electronics**

**(Reference example is motored version)**

Step1



Step2



Step3



Step4

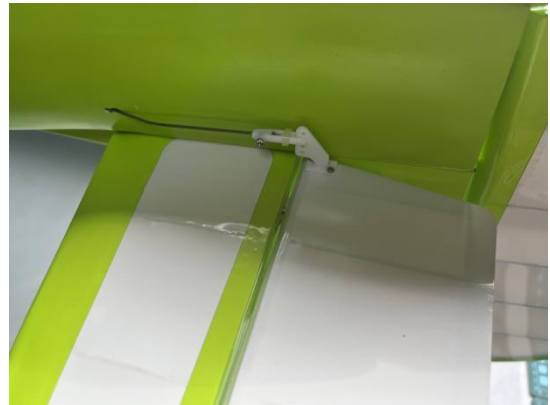

Step5

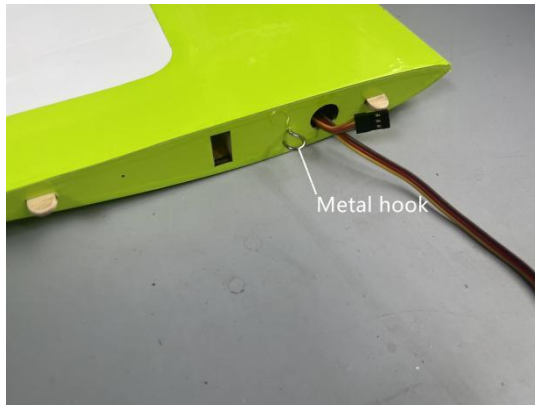

Step6



Step7



**Builder's note:**

## **BEFORE YOU FLY**

**1. CG: 85-90mm from the leading edge**



**2. Horizontal stabilizer mounting angle:**



<b>3.Control Travel</b>	
ELEVATOR	$\pm 15^\circ$
RUDDER	$\pm 15^\circ$
AILERON	$+30^\circ -10^\circ$

**Thank you!**



**Tony Ray's AeroModel**