

EUROFIGHTER TYPHOON

Wingspan:1030mm

Length:1450mm

Empty Weight:3230G[w/o Battery]



⚠️ 飞行注意事项：

- 1.首次飞行前需要给电调校准油门，否则涵道无法发挥出最大推力。
- 2.更换摇控器后需要给电调校准油门，否则涵道无法发挥出最大推力。
- 3.反推刹车：需要使用油门反推刹车功能的，需将油门反推刹车信号线插入到接收机的一个空闲开关通道上（信号范围和油门行程一致），通过该通道控制电机正反转，通道行程0-50%为电机默认设置转向，通道行程50%-100%触发电机反转。触发反转时，电机先刹停，再反转加速至油门摇杆输出的油门量。初次上电该通道摇杆所处位置需为该通道行程0-50%范围内（最好为0），否则电调通电以后会提示油门信号丢失报警。

⚠️ Flight precautions :

- 1.Before the first flight, ESC needs to calibrate the throttle, otherwise, the EDF power system cannot exert its maximum thrust.
- 2.After replace the other Remote Control, ESC needs to calibrate the throttle, otherwise, the EDF power system cannot exert its maximum thrust.
- 3.Reverse thrust function:When use the throttle reverse thrust function, the throttle reverse thrust signal cable should be inserted into an idle switch channel of the receiver (the signal range is consistent with the throttle travel), through which the forward and reverse rotation of the motor can be controlled. The channel travel is 0-50% of the motor's default setting direction, and the channel travel is 50% - 100% to trigger the motor's reverse rotation. When the reverse rotation is triggered, the motor stops first, and then reverses and accelerates to the throttle output of the throttle rocker.When the power is turned on for the first time, the rocker position of this channel should be within the range of 0-50% of the channel travel (preferably 0), otherwise the alarm of the throttle signal loss will be prompted after the power is turned on.



EN	1~14
中	15~27

- 1 Note
- 2 Product basic information
- 2 Package list
- PNP Assembly instructions
- 3 Install fuselage
- 4 Install canard
- 4 Install main wing
- 5 Install main wing
- 6 Install vertical stabilizer
- 6 Install nose cone
- 6 Install missiles
- 7 Install small plastic parts
- 8 Install battery
- 8 Pushrod instructions
- 8 Important additional notes
- 9 Center of gravity
- 9 Canard wing install diagram
- PNP Parameter setting
- 10 Setting and adjustment instructions
- 11 Flight precautions
- 12 Control direction test
- 13 Dual rates
- 13 Remote control EXP setting suggestion
- Pre-installed component overview
- 14 Servo direction
- 14 Motor specification

- 1.This is not a toy! Operater should have a certain experience, beginners should operate under the guidance of professional players.
- 2.Before install, please read through the instructions carefully and operate strictly under instructions.
- 3.Cause of wrong operation, Freewing and its vendors will not be held responsible for any losses.
- 4.Model planes' players must be on the age of 14 years old.
- 5.This plane used the EPO material with surface spray paint, don't use chemical to clean, otherwise it will damage.
- 6.You should be careful to avoid flying in areas such as public places, high-voltage-intensive areas, near the highway, near the airport or any other place where laws and regulation clearly prohibit.
- 7.You cannot fly in bad weather conditions such as thunderstorms, snows....
- 8.Model plane's battery, don't allowed to put in everywhere. Storage must ensure that there is no inflammable and explosive materials in the round of 2M range.
- 9.Damaged or scrap battery should be properly recycled, it can't discard to avoid spontaneous combustion and fire.
- 10.In flying field, the waste after flying should be properly handled, it can't be abandoned or burned.
- 11.In any case, you must ensure that the throttle is in the low position and transmitter switch on, then it can connect the lipo-battery in aircraft.
- 12.Do not try to take planes by hand when flying or slow landing process. You must wait for landing stop, then carry it.

⚠ NOTE: This is not a toy. Not for children under 14 years. Young people under the age of 14 should only be permitted to operate this model under the instruction and supervision of an adult. Please keep these instructions for further reference after completing model assembly.

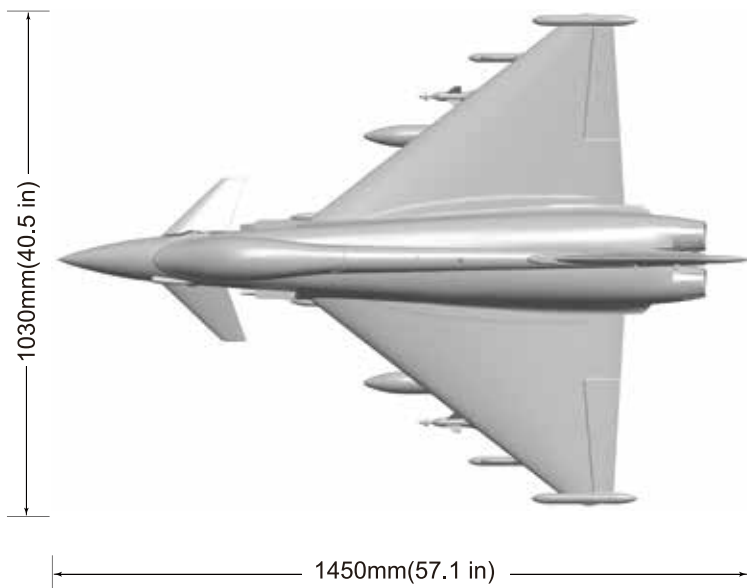

Standard Version

Wingload: 129 g/dm²
 Wing Area: 31 dm²
 Motor: 3668-1960KV I/R Motor
 Servo: 9g Hybrid digital servo ×4
 9g MG digital servo ×2
 17g MG digital servo ×3
 ESC: 120A Brushless ESC (Thrust Reverse Function)
 Ducted fan: 90mm 12-blade fan
 Weight: 3230g (w/o Battery)

Other features

Material: EPO
 Aileron: Yes Canard: Yes
 Rudder: Yes
 Landing gear: Electric Landing Gear
 Cabin door: Nose gear cabin door
 Rear gear cabin door
 Scale Pilot figure
 Li-Po Battery: 6S 5000-6000mAh (1pcs)

⚠ Note: The parameters in here are derived from test result using our accessories. If use other accessories, the test result will be different. Any problem since of using other accessories, we are not able to provide technical support.

Package List

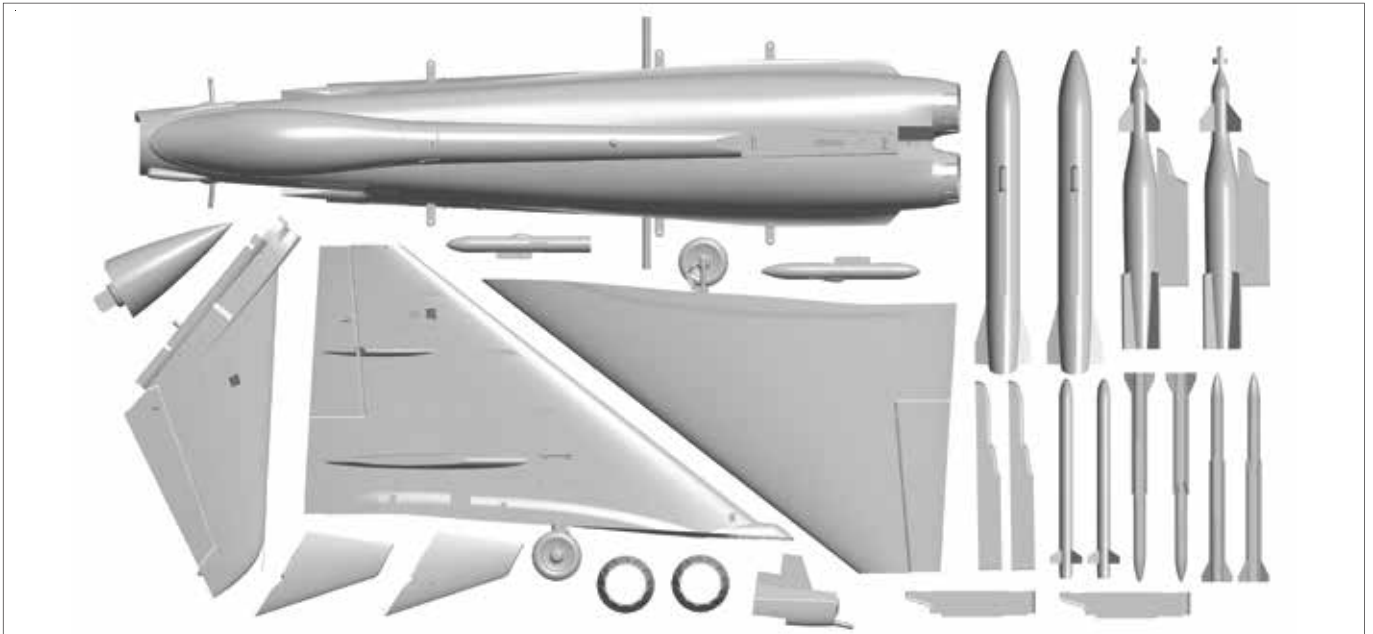

Different equipment include different spareparts. Please refer to the following contents to check your sparepart list.

No.	Name	PNP	ARF Plus
1	Fuselage	Pre-installed all electronic parts	Pre-installed servo
2	Main wing	Pre-installed all electronic parts	Pre-installed servo
3	Canard	✓	✓
4	Vertical tail	Pre-installed all electronic parts	Pre-installed servo
5	Nose cone	✓	✓

No.	Name	PNP	ARF Plus
6	Missiles	✓	✓
7	Pylons	✓	✓
6	Pushrod	✓	✓
7	Screw bag	✓	✓
8	Manual	✓	✓

Install Fuselage

As the photo show :
1. Use glue to install the tail foam part on the fuselage.

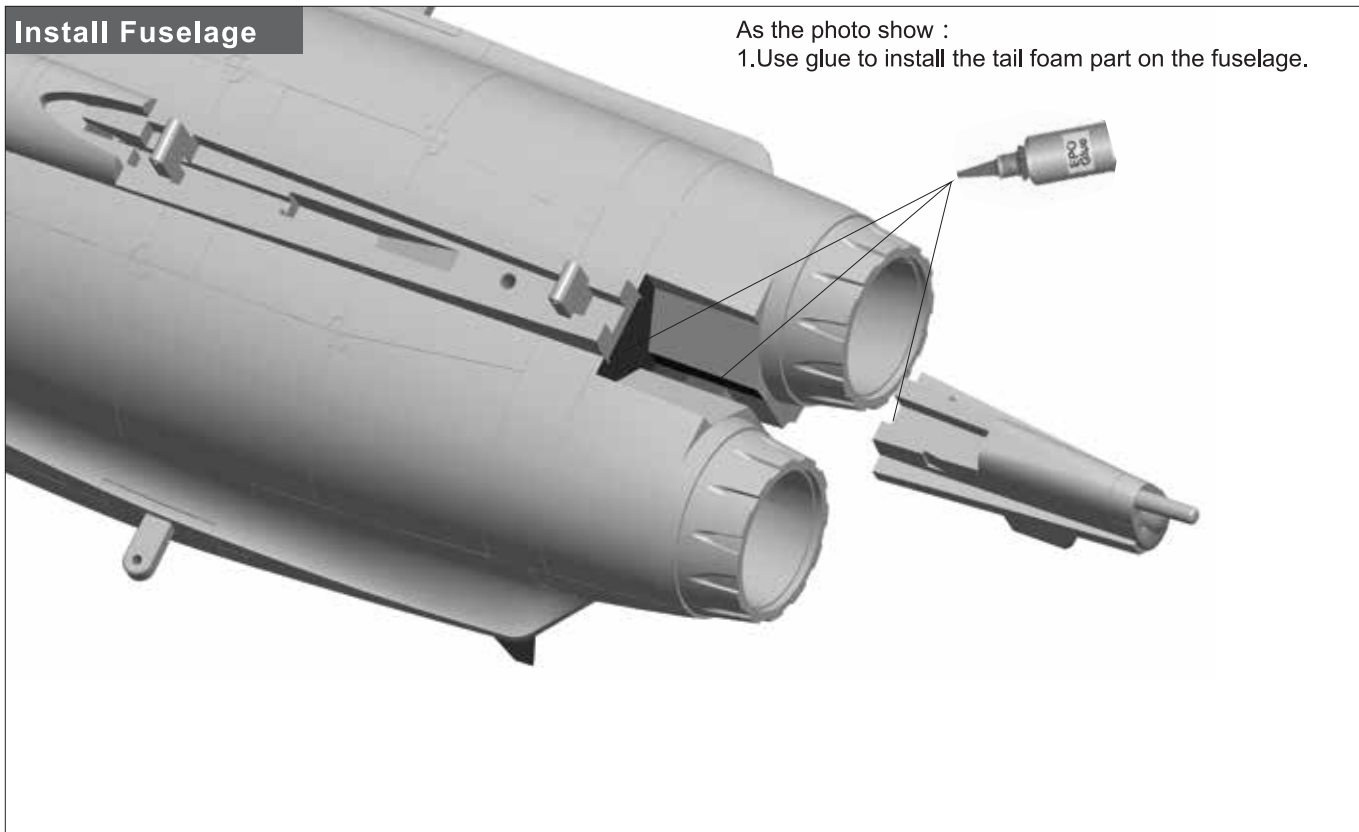

2. Use glue to install the tail nozzle on the fuselage.

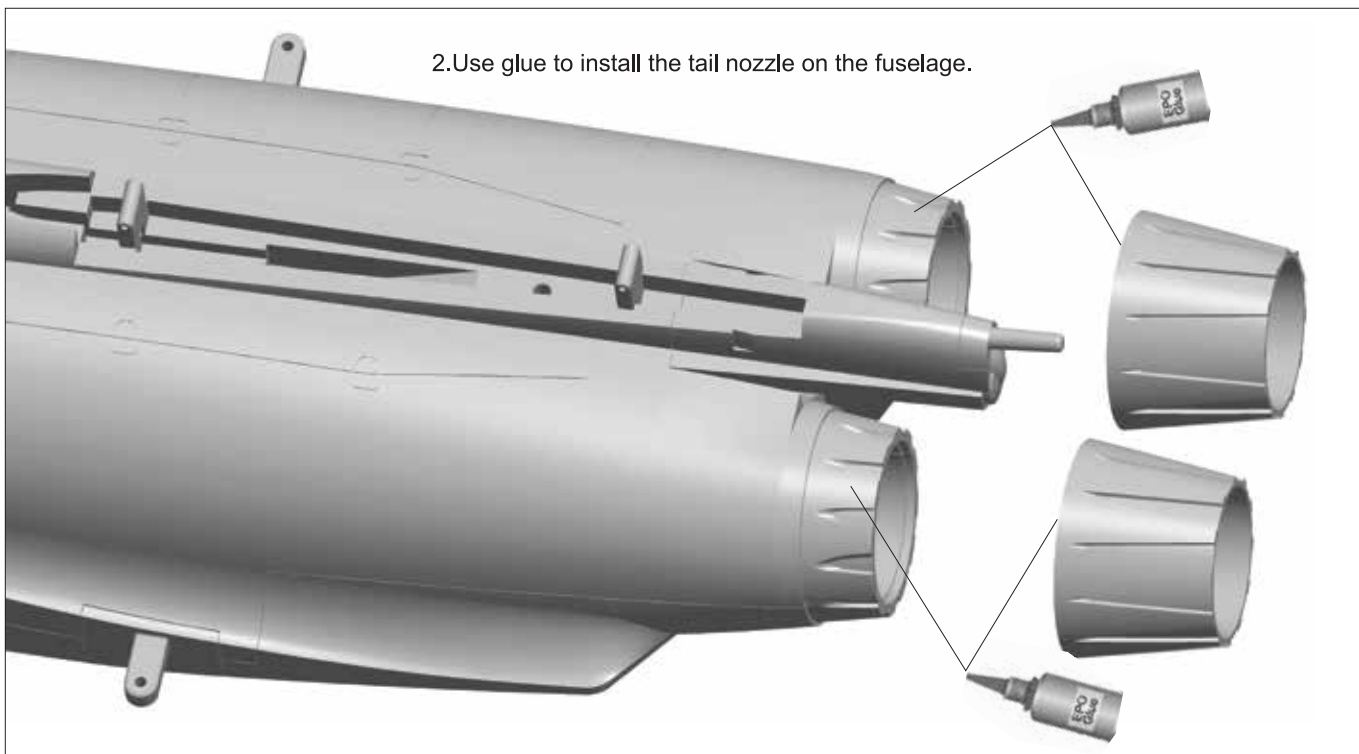

Install Canard

As the photo show :

1. Turn over the fuselage to belly up, then install the canard.
2. Put the canard into the rotating shaft, and confirm that the screw holes on the canard plastic part completely overlap with the screw holes on the rotating shaft, and then lock in the screws to fix them.

Screw (KM3X6mm 2PCS)

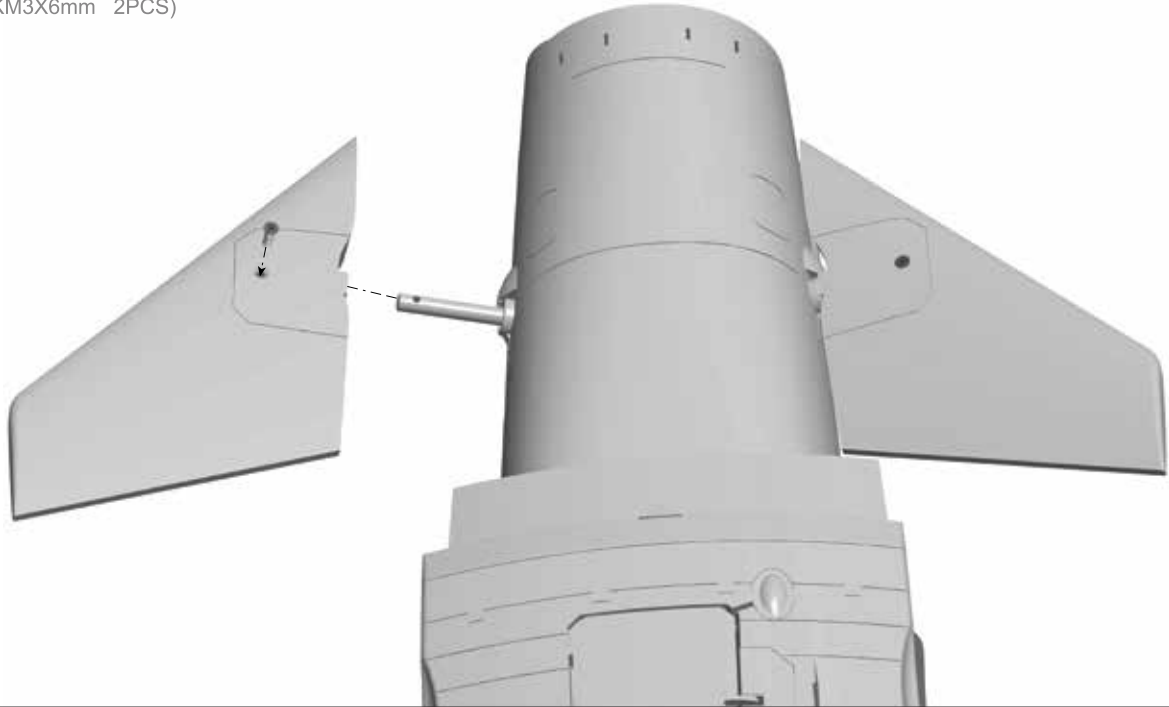

Install Main Wing

As the photo show :

1. Connect the LED light plug of wingtip on the LED light plug of main wing. (Note that there are positive and negative poles).
2. Install the left/right wingtip cowling on the main wing, and fix it by screw.

Screw (KA3X10mm 4PCS)

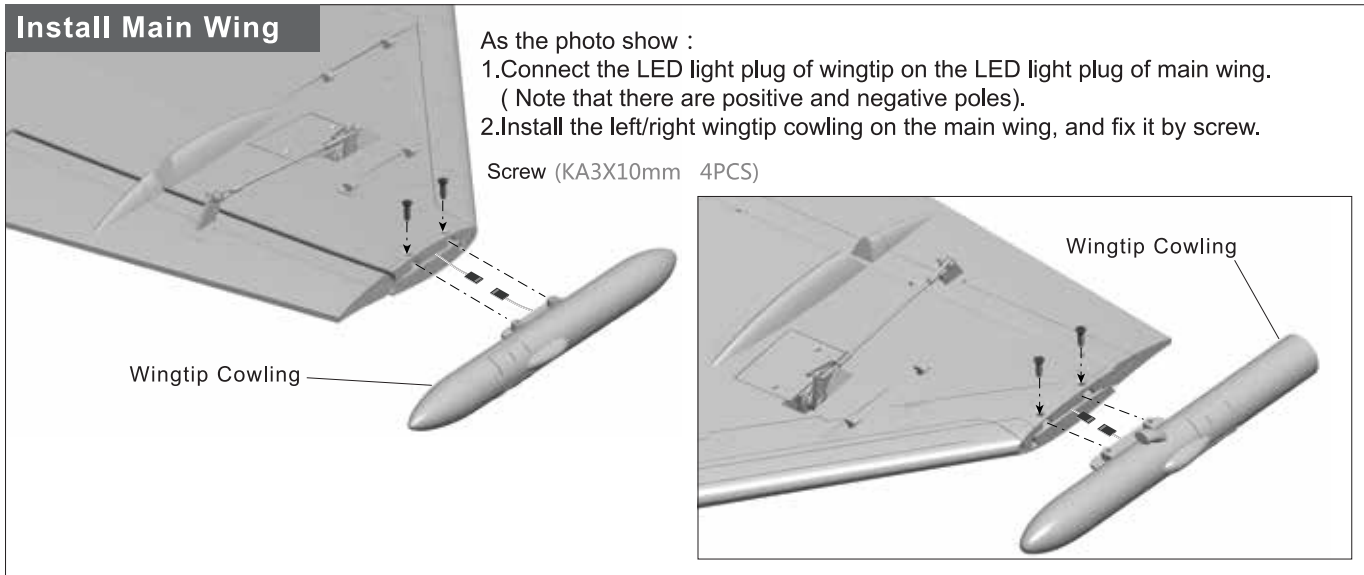

As the photo show :

1. Open the rear cabin door, and insert the ribbon wire to the main wing control board, then install the main wing on the fuselage and fix it by screws.

Screw (M4X16mm 6PCS)

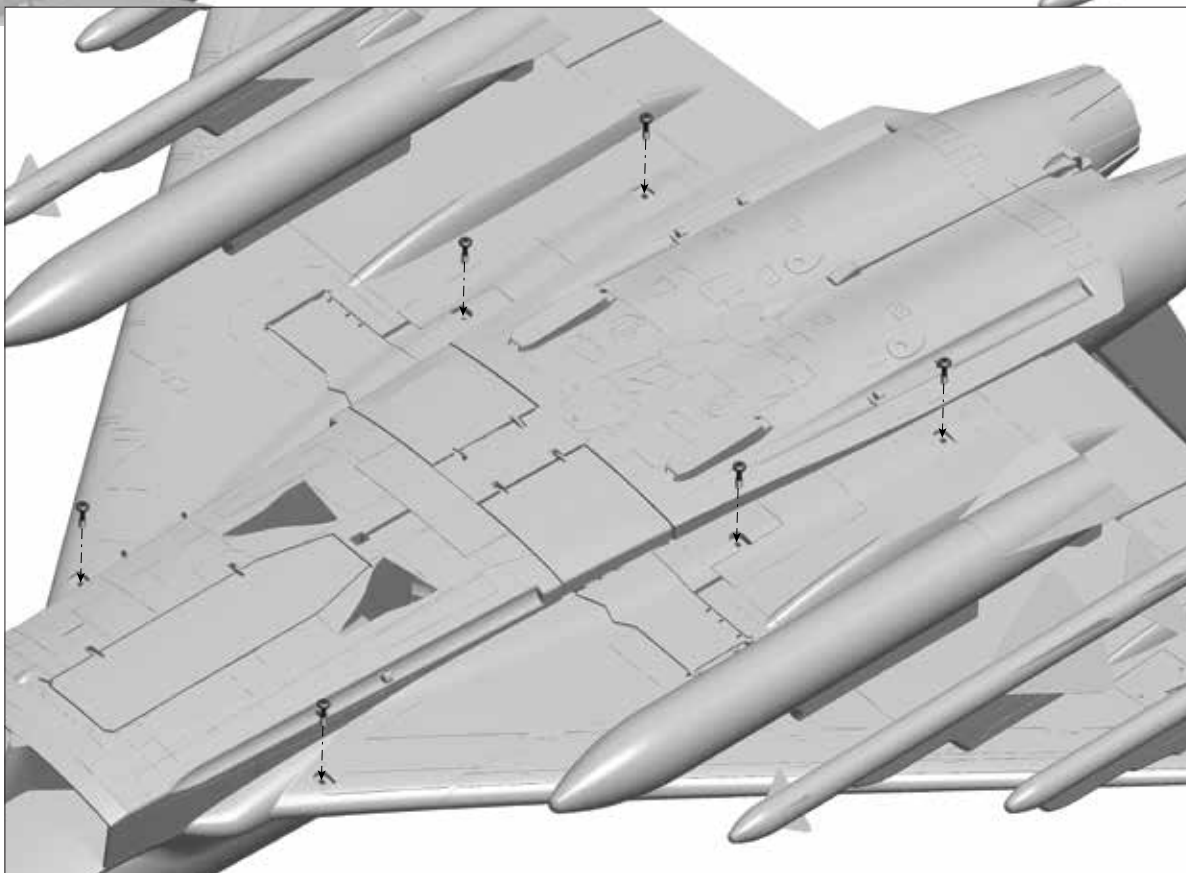
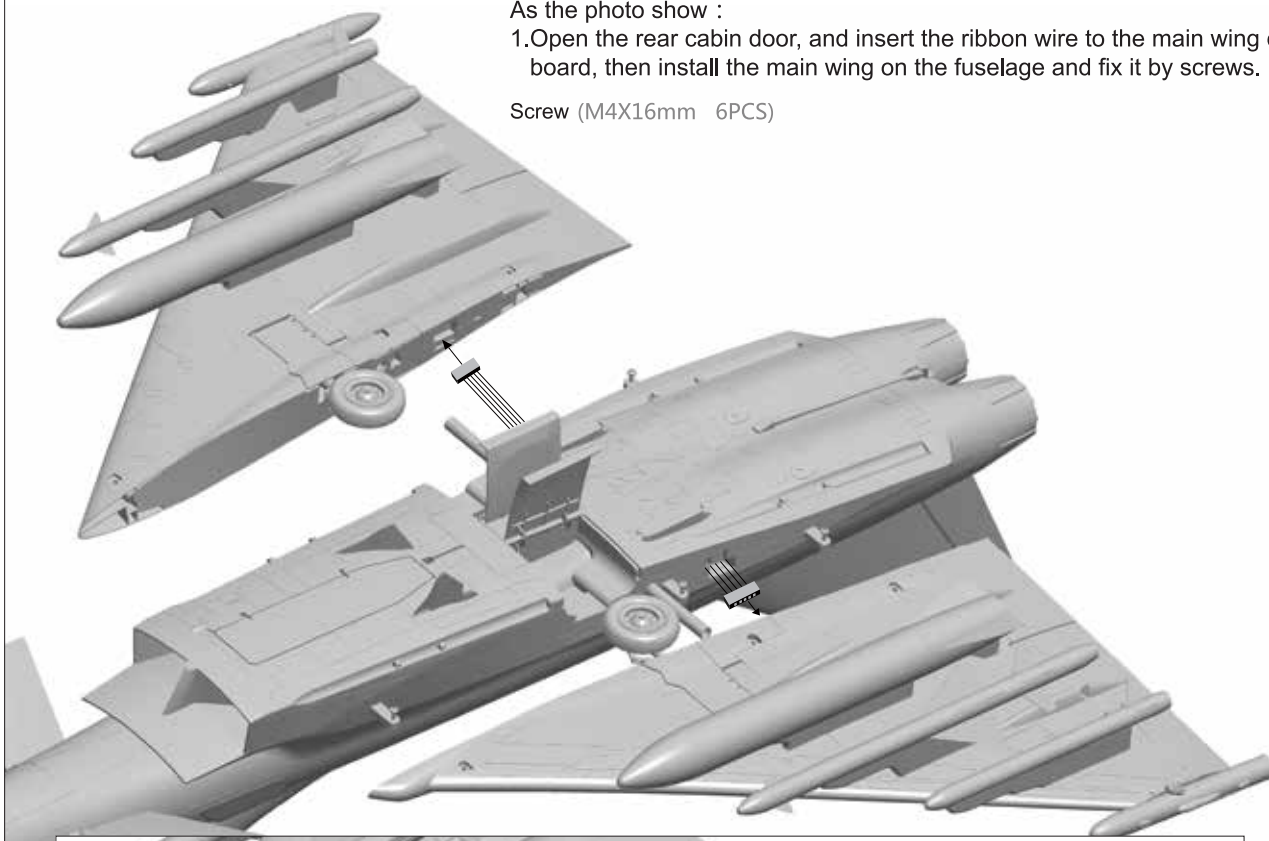

Install Vertical Stabilizer

As the photo show :

1. Connect the rudder servo extension cable and fuselage extension cable, and install the vertical stabilizer on the fuselage with screws.

Screw (KA3X10mm 4PCS)

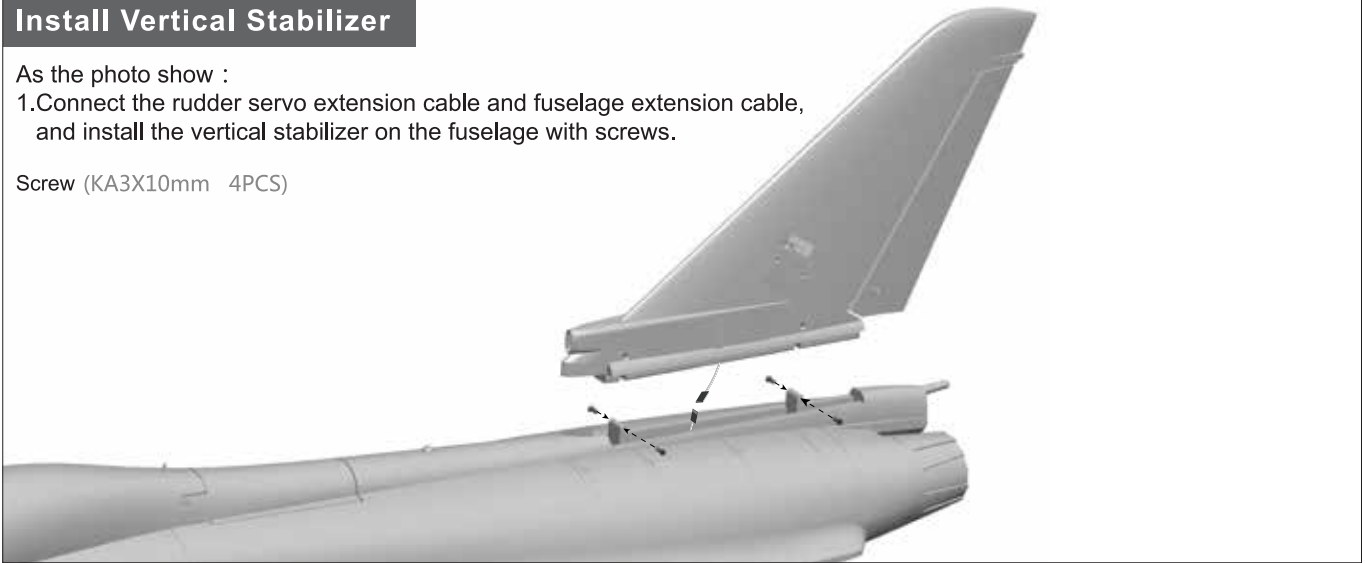

Install Nose Cone

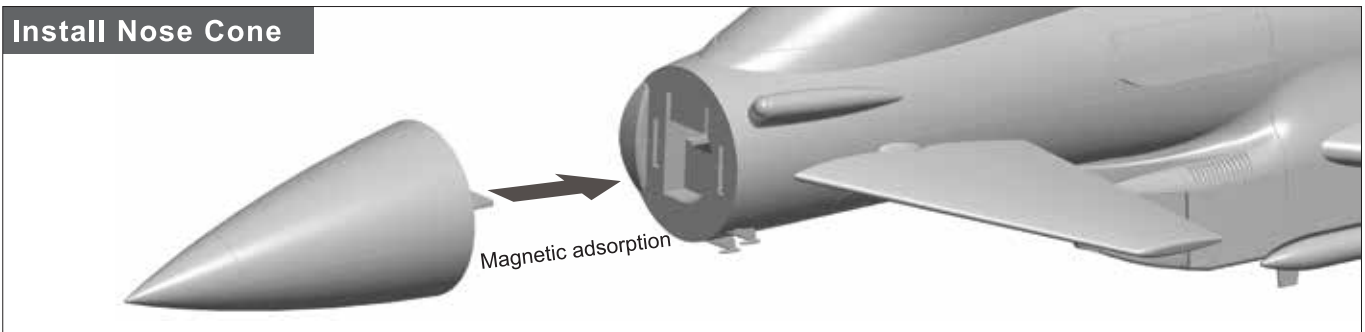

Install Missiles

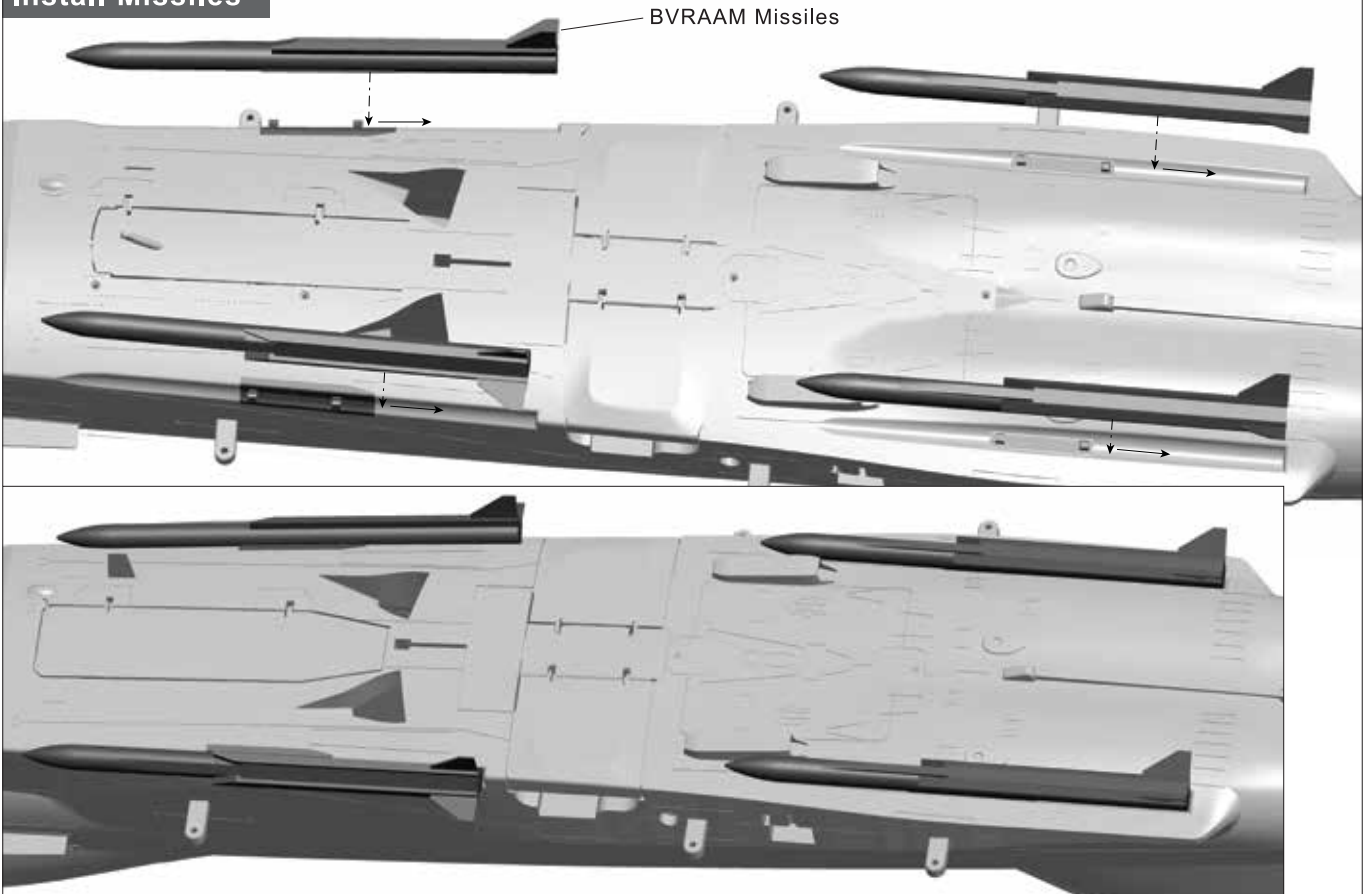

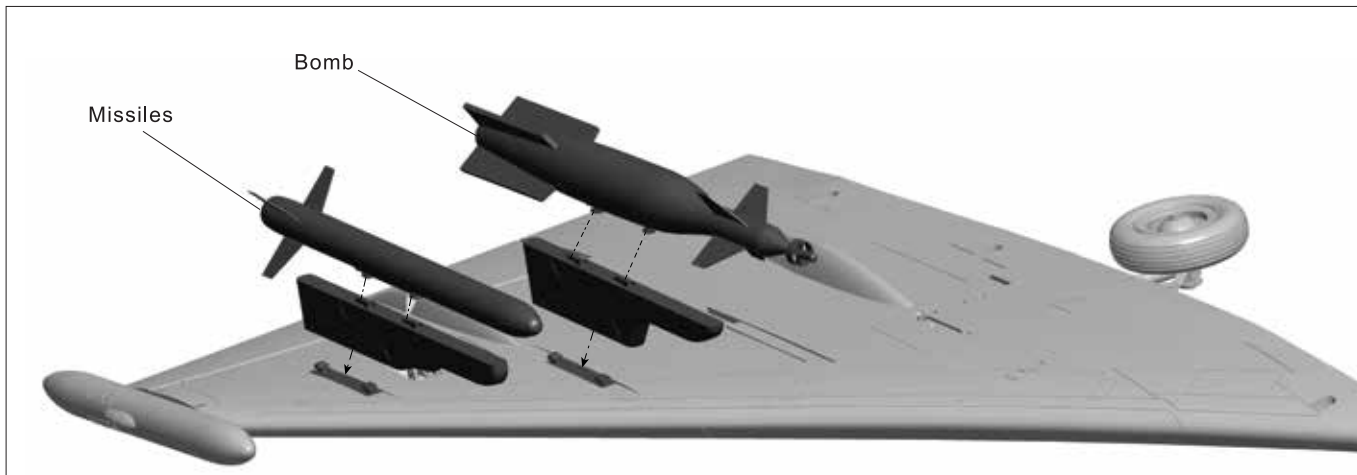

Install Small Plastic Parts

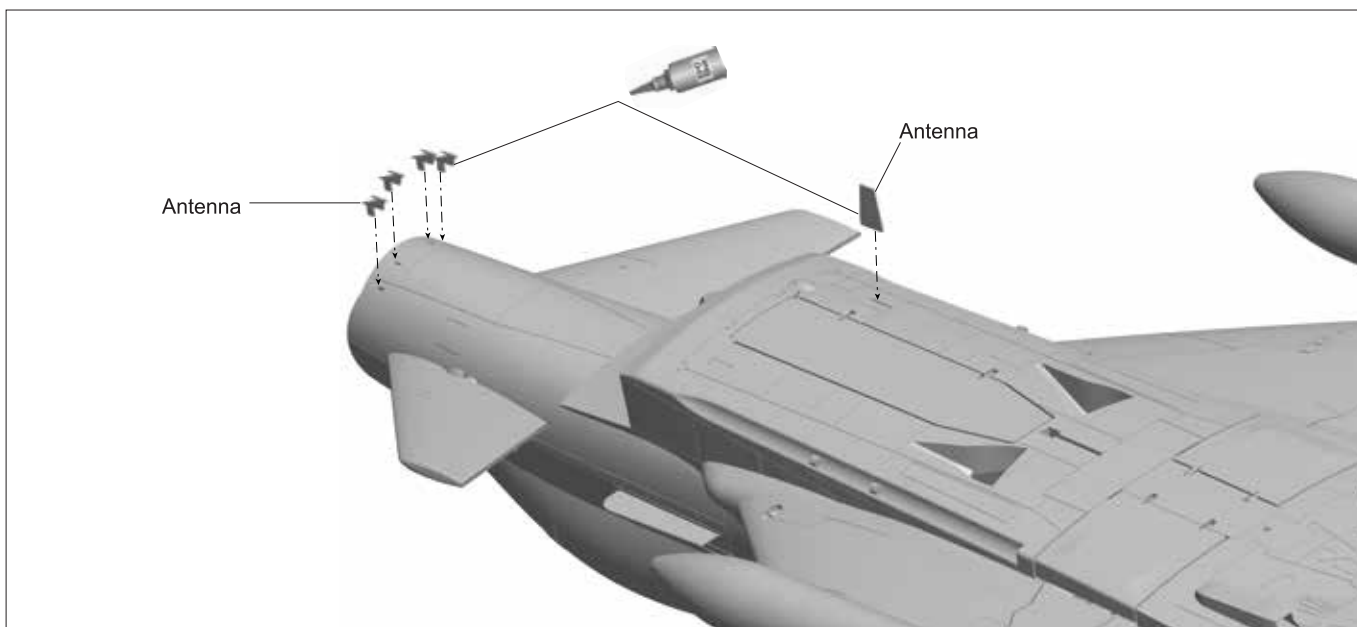
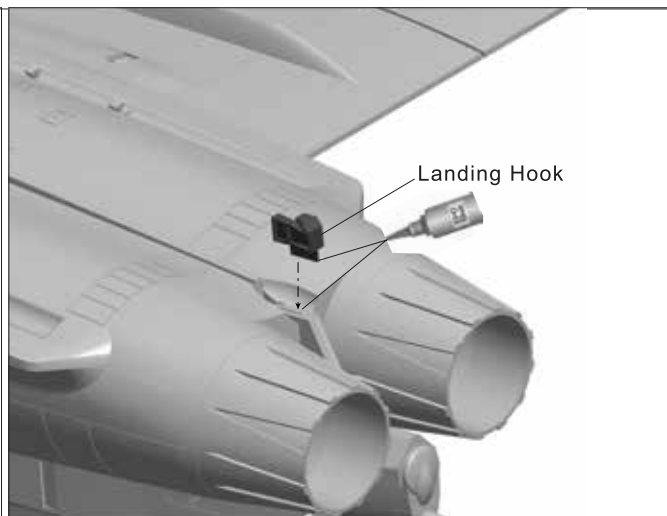
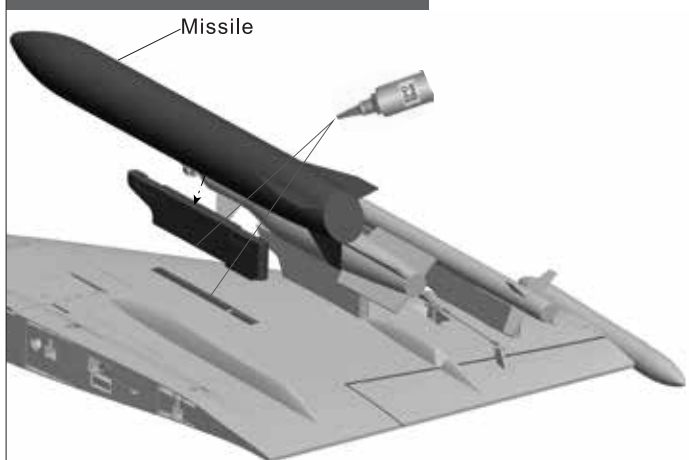

Install Battery

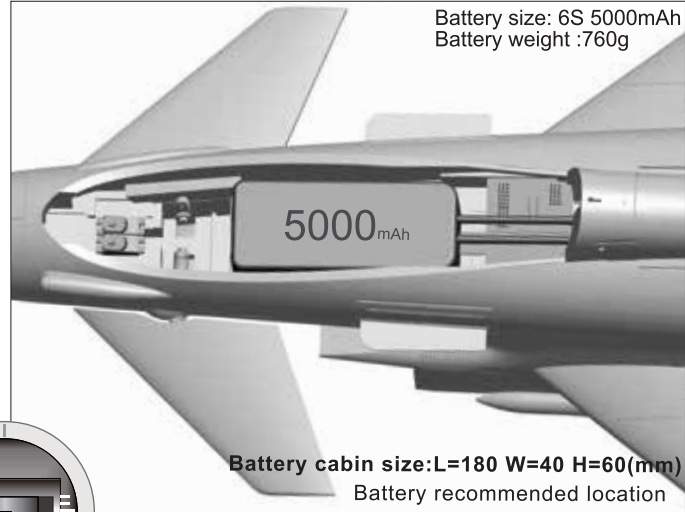
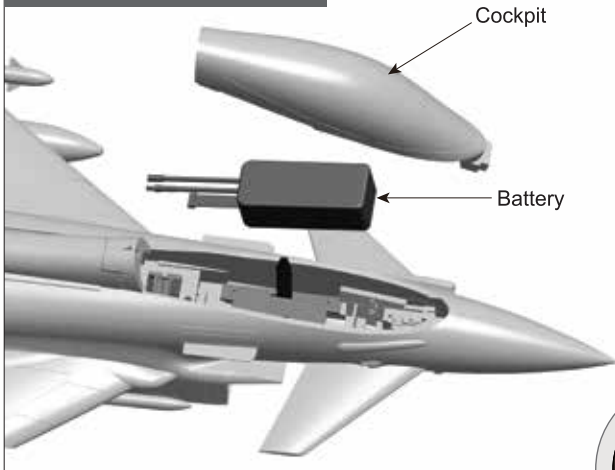

Before connecting the battery and receiver, please switch on the transmitter power and make sure the throttle stick is in the lowest position. Bind your receiver to your transmitter according to your transmitter's instruction manual.

We recommend the following LiPo battery:
6S 22.2V 5000mAh~6S 22.2V 6000mAh
 Discharge rate of C ≥ 35C

Pushrod instructions

Nose gear steering pushrod length

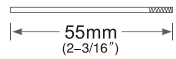

Pushrod diameter Ø1.2mm

Nose gear steering pushrod mounting hole



Nose cabin door pushrod length

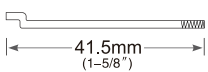

Pushrod diameter Ø1.2mm

Nose cabin door pushrod mounting hole



Rear follow-up cabin door pushrod length

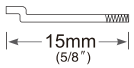

Pushrod diameter Ø1.2mm

Rear follow-up cabin door pushrod mounting hole



Rear cabin door pushrod length

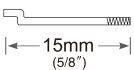

Pushrod diameter Ø1.2mm

Rear cabin door pushrod mounting hole



Aileron pushrod length

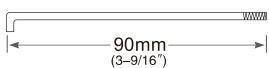

Pushrod diameter Ø1.5mm

Aileron pushrod mounting hole



Rudder pushrod length

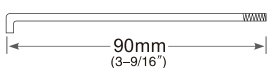

Pushrod diameter Ø1.5mm

Rudder pushrod mounting hole



Canard pushrod length

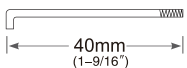

Pushrod diameter Ø1.5mm

Canard pushrod mounting hole



Important additional notes

The Y-type clevis used in this product is equipped with a transparent silicone ring for secondary reinforcement, which can effectively prevent the clevis from accidentally loosening.

As shown in the following figure, when you buckle the clevis into the control surface horn, use the silicone ring to cover the clevis.

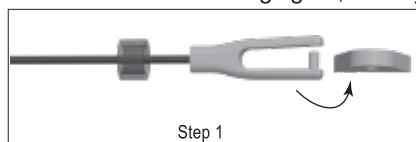

Step 1

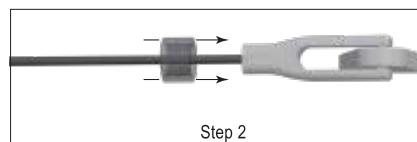

Step 2

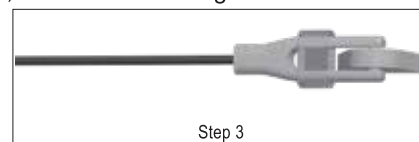

Step 3

Center of Gravity

Correct Center of Gravity ("CG") is critical for enabling safe aircraft stability and responsive control. Please refer to the following CG diagram to adjust your aircraft's Center of Gravity.

- Depending on the capacity and weight of your chosen flight batteries, move the battery forward or backward to adjust the Center of Gravity.
- If you cannot obtain the recommended CG by moving the battery to a suitable location, you can also install a counterweight to achieve correct CG. However, with the recommended battery size, a counterweight is not required. We recommend flying without unnecessary counterweight.

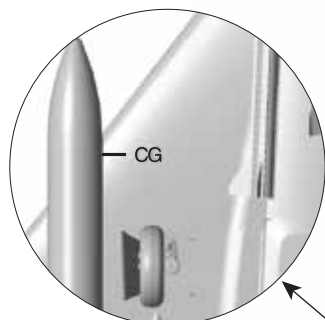

As the photo show, We marked the center of gravity on the bottom of the Main wing. Please confirm the CG based on this marked position.

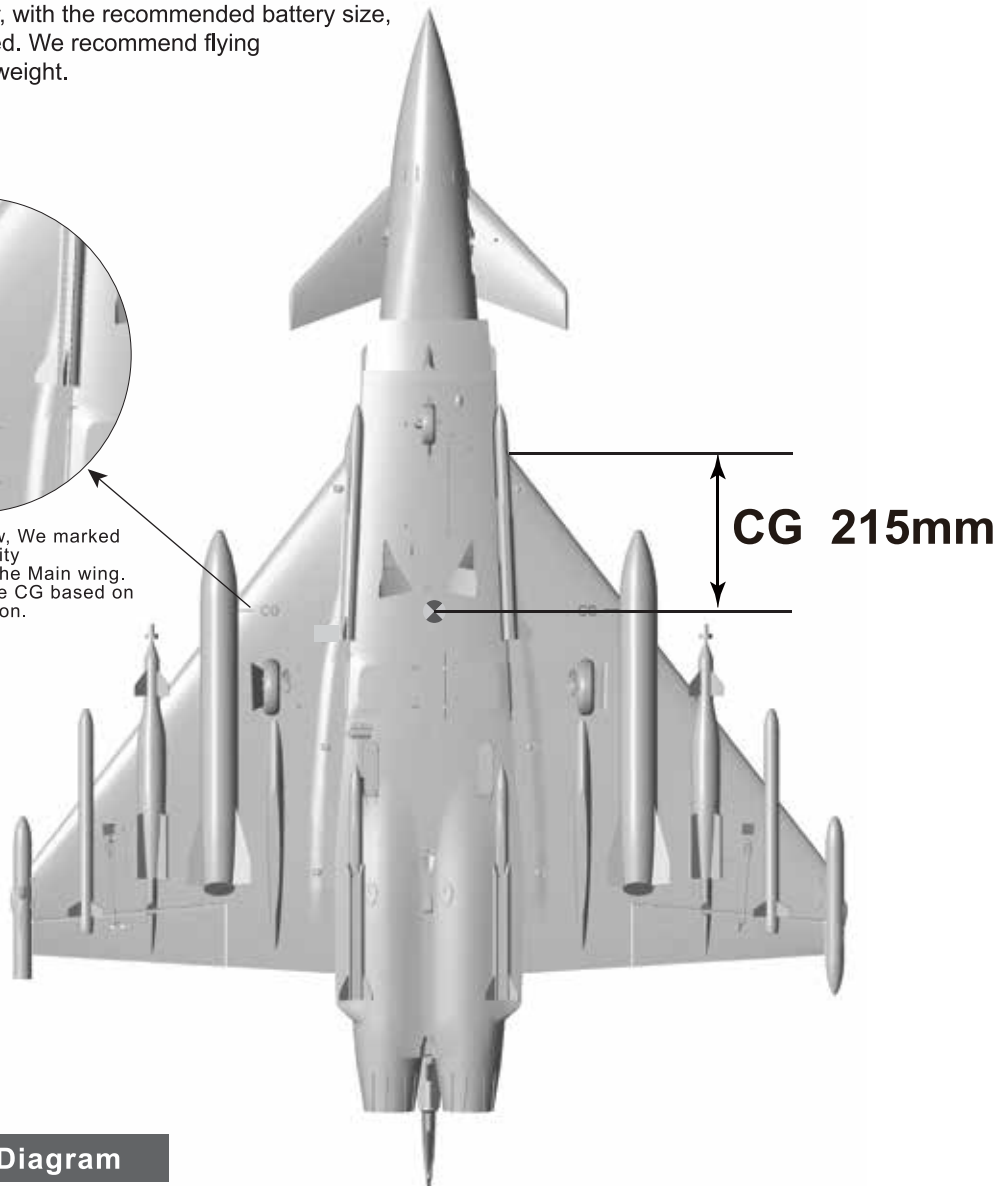

Canard Wing Install Diagram

The installation position of canard wing is shown in the below, there is a scale on the fuselage, you can use the leading edge of the canard to align with the scale line (the black line in the figure below).

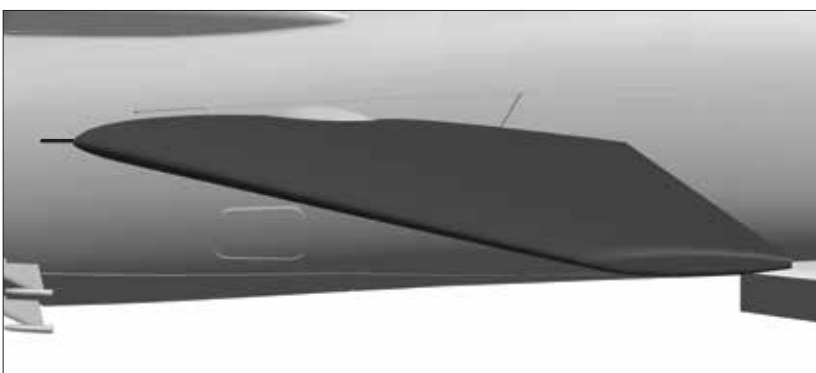

Setting and Adjustment Instructions

1. Eurofighter control board have been set the mix of delta wing and canard wing, so you don't need to set the mix at remote control, only need the normal fixed wing mode.

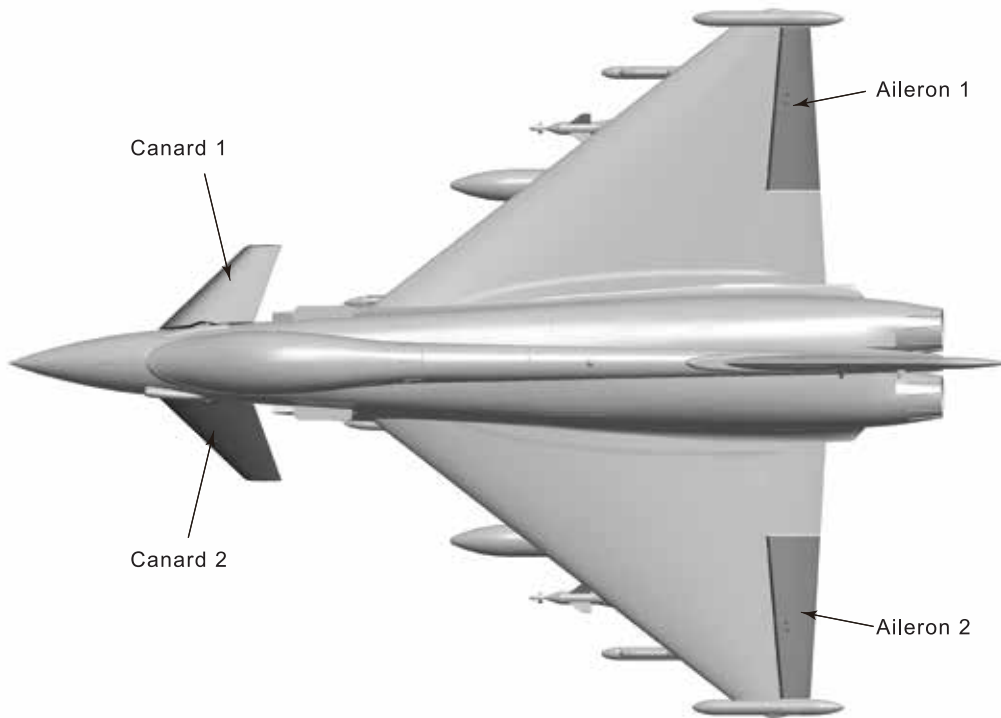

2. If you found the elevator control direction of Canard 1 and Canard 2 is not correct when you found in adjusting, please try to adjust and exchange the two canard plugs position on the control board, as the following photo show.

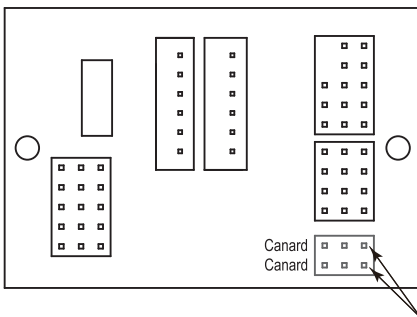

Please exchange the two canard plugs position

3. If you found the elevator control direction of elevator 1 and elevator 2 is not correct when you found in adjusting, please try to adjust and exchange the two six-pin-plugs position on the control board, as the following photo show.

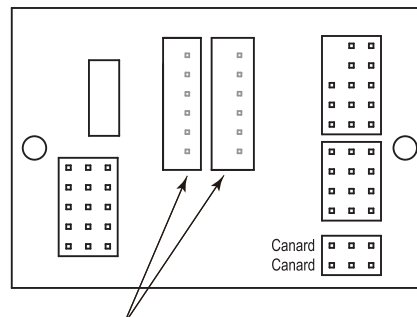

Please exchange the two six-pin-plugs position

4. Use method of Rear cabin door mode switch . Switch on is Dual stage mode, its: (Door Open—Gear Down—Door Close. And Door Open—Gear Up—Door Close). Switch off is Single stage mode, its: (Door Open—Gear Down. And Door Open—Gear Up) . It shown as the following photo:

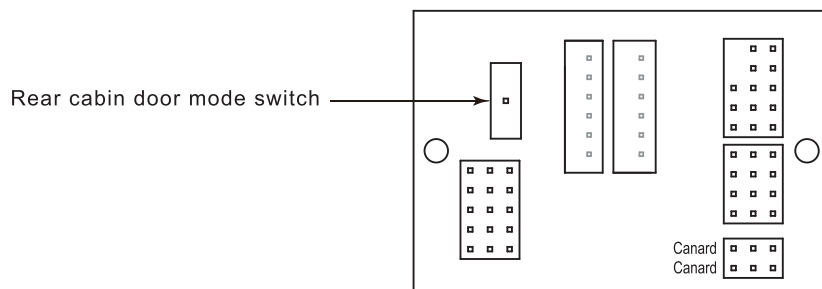

Flight Precautions

1. Before the first flight, ESC needs to calibrate the throttle, otherwise, the EDF power system cannot exert its maximum thrust.
2. After replace the other Remote Control, ESC needs to calibrate the throttle, otherwise, the EDF power system cannot exert its maximum thrust.
3. Reverse thrust function: When use the throttle reverse thrust function, the throttle reverse thrust signal cable should be inserted into an idle switch channel of the receiver (the signal range is consistent with the throttle travel), through which the forward and reverse rotation of the motor can be controlled. The channel travel is 0-50% of the motor's default setting direction, and the channel travel is 50% - 100% to trigger the motor's reverse rotation. When the reverse rotation is triggered, the motor stops first, and then reverses and accelerates to the throttle output of the throttle rocker. When the power is turned on for the first time, the rocker position of this channel should be within the range of 0-50% of the channel travel (preferably 0), otherwise the alarm of the throttle signal loss will be prompted after the power is turned on.

Control Direction Test

After installed the plane, before flying, we need a fully charged battery and connect to the ESC, then use radio to test and check that every control surface work properly.

Aileron

Stick Left



Stick Right



Canard

Stick down

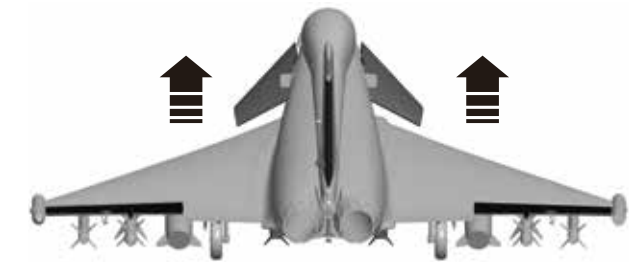

Stick up



Rudder

Stick Left



Stick Right



Dual Rates

According to our testing experience, use the following parameters to set Aileron/Elevator Rate. Program your preferred Exponential % in your radio transmitter. We recommend using High Rate for the first flight, and switching to Low Rate if you desire a lower sensitivity. On successive flights, adjust the Rates and Expo to suit your preference.

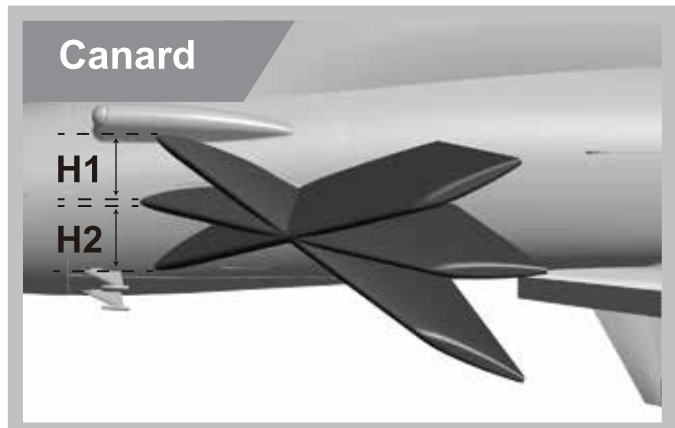
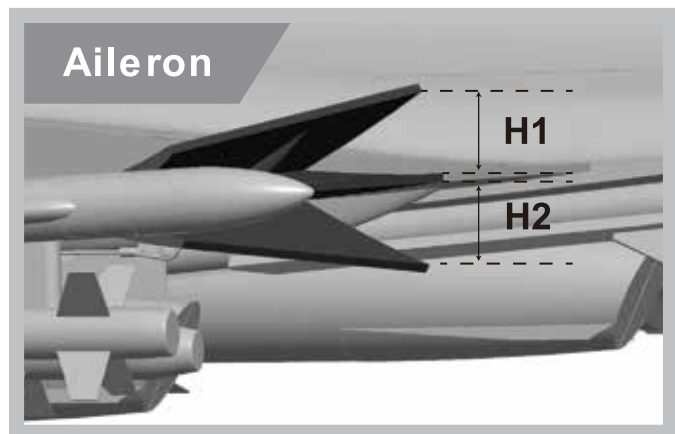

	Main Wing Aileron	Main Wing Elevator	Canard Aileron	Canard Elevator	Rudder
Low Rate	H1/H2 16mm/16mm D/R Rate : 40%	H1/H2 35mm/35mm D/R Rate : 80%	H1/H2 10mm/10mm D/R Rate : 40%	H1/H2 20mm/20mm D/R Rate : 80%	H1/H2 27mm/27mm D/R Rate : 80%
High Rate	H1/H2 24mm/24mm D/R Rate : 60%	H1/H2 43mm/43mm D/R Rate : 100%	H1/H2 15mm/15mm D/R Rate : 60%	H1/H2 26mm/26mm D/R Rate : 100%	H1/H2 32mm/32mm D/R Rate : 100%

Remote Control EXP Setting Suggestion

1. Aileron EXP curve is shown as below :

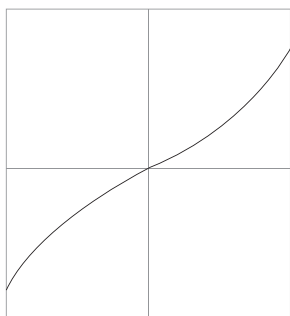

Futaba brand Remote Control : EXP A -30
EXP B -30

2. Elevator EXP curve is shown as below :

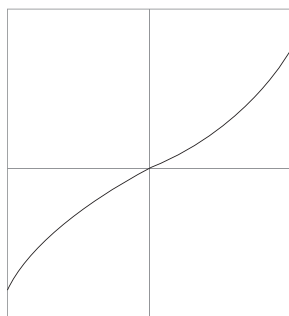

Futaba brand Remote Control : EXP A -30
EXP B -30

3. Rudder EXP curve is shown as below :

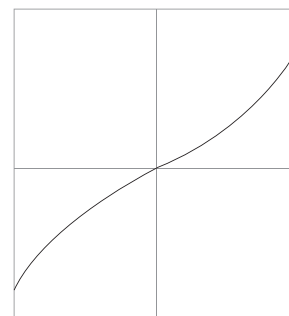

Futaba brand Remote Control : EXP A -30
EXP B -30

Spektrum brand Remote Control : EXPO 30% 30% Spektrum brand Remote Control : EXPO 30% 30% Spektrum brand Remote Control : EXPO 30% 30%

Servo Direction

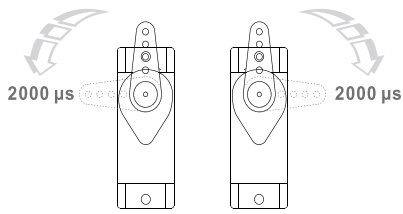

The servo positive or reverse rotation is defined as follows:
 When servo input signal change from 1000μs to 2000μs,
 The servo arm is **rotated clockwise**, its **positive servo**.
 The servo arm is **rotated counterclockwise**, its **reverse servo**.

If you need to purchase another brand's servo, please refer to the following list to choose a suitable servo.

Position	Servo regulation	No.	Pos. / Rev.	Cable length
Nose gear steering servo	9g Digital-Hybrid	1	Positive	200mm
Landing gear door	9g Digital-Hybrid	2	Positive	200mm
Rear cabin door left	9g Digital-Hybrid	3	Positive	500mm
Rear cabin door right	9g Digital-Hybrid	4	Reverse	500mm
Aileron(L)	17g Digital-MG	5	Positive	300mm
Aileron(R)	17g Digital-MG	6	Positive	300mm
Canard(L)	9g Digital-MG	7	Positive	400mm
Canard(R)	9g Digital-MG	8	Positive	400mm
Rudder	17g Digital-MG	9	Positive	100mm

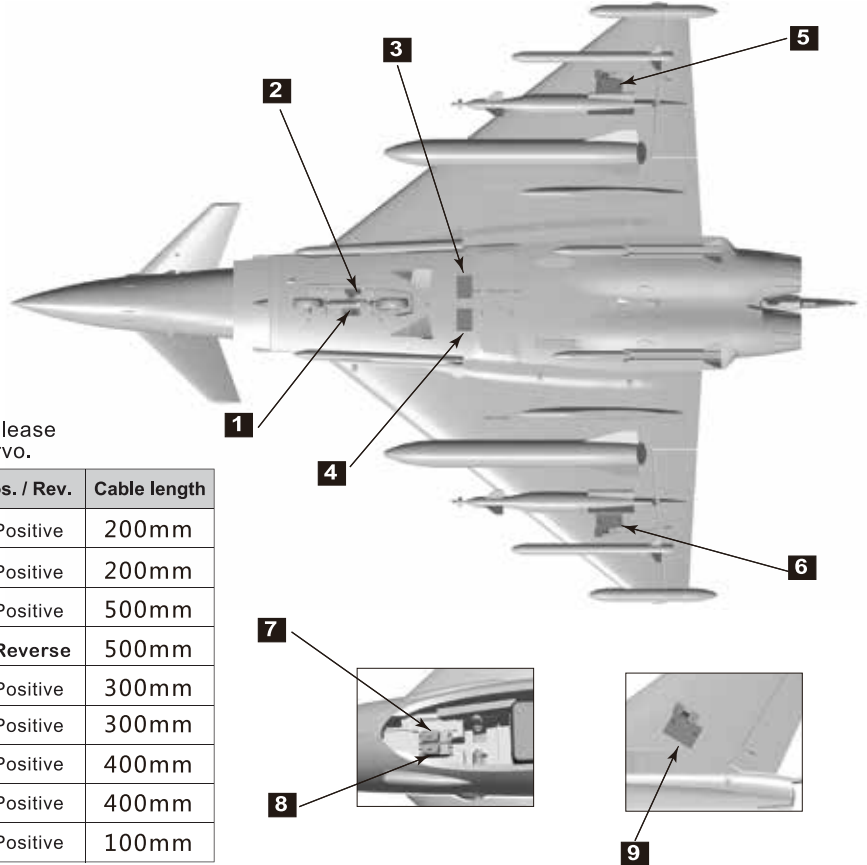

Motor Specification

3668-1960
 Item No.:MI036681

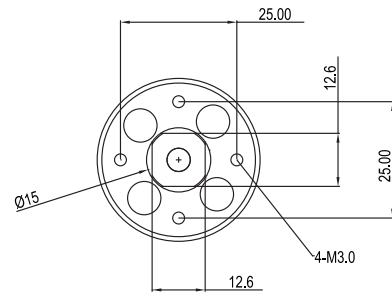
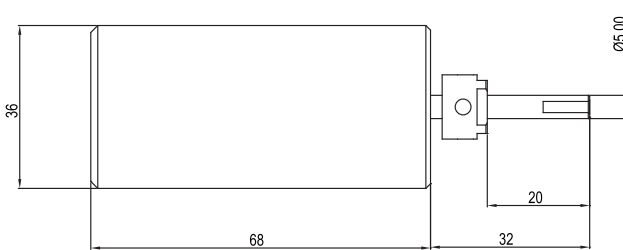

Unit :mm

3668-1960KV

Item No.	EDF Fans	Use voltage (V)	Current(A)	Max power (W)	Thrust(g)	Efficiency (g/w)	Motor(KV)	Use ESC (A)	Weight (g)
E72216	90mm 12-Blade	22.2	110	2442	4300	1.76	3668-1960	120	400