

1/10 LUXURY ELECTRIC TOURING CAR FWD

XRAY X4F



INSTRUCTION MANUAL
FOR X4F'24 EDITION

BEFORE YOU START

This is a high-competition, high-quality RC car intended for persons aged 16 years and older with previous experience building and operating RC model racing cars. This is not a toy; it is a precision racing model. This model racing car is not intended for use by beginners, inexperienced customers, or by children without direct supervision of a responsible, knowledgeable adult. If you DO NOT fulfill these requirements, please return the kit in unused and unassembled form back to the shop where you have purchased it.

Before building and operating your XRAY, YOU MUST read through all of the operating instructions and instruction manual and fully understand them to get the maximum enjoyment and prevent unnecessary damage.

CUSTOMER SUPPORT

We have made every effort to make these instructions as easy to understand as possible. However, if you have any difficulties, problems, or questions, please DO NOT hesitate to contact the XRAY support team at info@teamxray.com. Also, please visit our Web site at www.teamxray.com to find the latest updates, set-up information, option parts, and many other goodies. We pride ourselves on taking excellent care of our customers.

You can join thousands of XRAY fans and enthusiasts in our online community at: www.teamxray.com

Read carefully and fully understand the instructions before beginning assembly.

Make sure you review this entire manual, download and use set-up book from the web, and examine all details carefully. If for some reason you decide this is not what you wanted or expected, **DO NOT continue any further**. Your hobby dealer can not accept your kit for return or exchange after it has been partially or fully assembled.

Contents of the box may differ from pictures. In line with our policy of continuous product development, the exact specifications of the kit may vary without prior notice.

XRAY Europe

K Vystavisku 6992
91101 Trenčín
Slovakia, EUROPE
Phone: 421-32-7401100
Fax: 421-32-7401109
E-mail: info@teamxray.com

XRAY USA

RC America, 2030 Century Center Blvd #15
Irving, TX 75062
USA
Phone: (214) 744-2400
Fax: (214) 744-2401
E-mail: xray@rcamerica.com

FAILURE TO FOLLOW THESE INSTRUCTIONS WILL BE CONSIDERED AS ABUSE AND/OR NEGLIGENCE.

SAFETY PRECAUTIONS

Contains:

LEAD (CAS 7439-92-1) ANTIMONY (CAS 7440-36-0)

WARNING: This product contains a chemical known to the state of California to cause cancer and birth defects or other reproductive harm.

CAUTION: CANCER HAZARD

Contains lead, a listed carcinogen. Lead is harmful if ingested. Wash thoroughly after using. DO NOT use product while eating, drinking or using tobacco products. May cause chronic effects to gastrointestinal tract, CNS, kidneys, and blood. MAY CAUSE BIRTH DEFECTS.

When building, using and/or operating this model always wear protective glasses and gloves.

Take appropriate safety precautions prior to operating this model. You are responsible for this model's assembly and safe operation! Please read the instruction manual before building and operating this model and follow all safety precautions. Always keep the instruction manual at hand for quick

reference, even after completing the assembly. Use only genuine and original authentic XRAY parts for maximum performance. Using any third party parts on this model will void warranty immediately.

Improper operation may cause personal and/or property damage. XRAY and its distributors have no control over damage resulting from shipping, improper construction, or improper usage. XRAY assumes and accepts no responsibility for personal and/or property damages resulting from the use of improper building materials, equipment and operations. By purchasing any item produced by XRAY, the buyer expressly warrants that he/she is in compliance with all applicable federal, state and local laws and regulation regarding the purchase, ownership and use of the item. The buyer expressly agrees to indemnify and hold harmless XRAY for all claims resulting directly or indirectly from the purchase, ownership or use of the product. By the act of assembling or operating this product, the user accepts all resulting liability. If the buyer is not prepared to accept this liability, then he/she should return this kit in new, unassembled, and unused condition to the place of purchase.



IMPORTANT NOTES - GENERAL

- This product is not suitable for children under 16 years of age without the direct supervision of a responsible and knowledgeable adult.
- Carefully read all manufacturers warnings and cautions for any parts used in the construction and use of your model.
- Assemble this kit only in places away from the reach of very small children.
- First-time builders and users should seek advice from people who have building experience in order to assemble the model correctly and to allow the model to reach its performance potential.
- Exercise care when using tools and sharp instruments.
- Take care when building, as some parts may have sharp edges.
- Keep small parts out of reach of small children. Children must not be allowed to put any parts in their mouth, or pull vinyl bag over their head.
- Read and follow instructions supplied with paints and/or cement, if used (not included in kit).
- Immediately after using your model, DO NOT touch equipment on the model such as the motor and speed controller, because they generate high temperatures. You may seriously burn yourself seriously touching them.
- Follow the operating instructions for the radio equipment at all times.
- DO NOT put fingers or any objects inside rotating and moving parts, as this may cause damage or serious injury as your finger, hair, clothes, etc. may get caught.
- Be sure that your operating frequency is clear before turning on or running your model, and never share the same frequency with somebody else at the same time. Ensure that others are aware of the operating frequency you are using and when you are using it.
- Use a transmitter designed for ground use with RC cars. Make sure that no one else is using the same frequency as yours in your operating area. Using the same frequency at the same time, whether it is driving, flying or sailing, can cause loss of control of the RC model, resulting in a serious accident.
- Always turn on your transmitter before you turn on the receiver in the car. Always turn off the receiver before turning your transmitter off.
- Keep the wheels of the model off the ground when checking the operation of the radio equipment.
- Disconnect the battery pack before storing your model.
- When learning to operate your model, go to an area that has no obstacles that can damage your model if your model suffers a collision.
- Remove any sand, mud, dirt, grass or water before putting your model away.
- If the model behaves strangely, immediately stop the model, check and clear the problem.
- To prevent any serious personal injury and/or damage to property, be responsible when operating all remote controlled models.
- The model car is not intended for use on public places and roads or areas where its operation can conflict with or disrupt pedestrian or vehicular traffic.
- Because the model car is controlled by radio, it is subject to radio interference from many sources that are beyond your control. Since radio interference can cause momentary loss of control, always allow a safety margin in all directions around the model in order to prevent collisions.
- DO NOT use your model:
 - Near real cars, animals, or people that are unaware that an RC car is being driven.
 - In places where children and people gather
 - In residential districts and parks
 - In limited indoor spaces
 - In wet conditions
 - In the street
 - In areas where loud noises can disturb others, such as hospitals and residential areas.
 - At night or anytime your line of sight to the model may be obstructed or impaired in any way.

To prevent any serious personal injury and/or damage to property, please be responsible when operating all remote controlled models.

XRAY

IMPORTANT NOTES - ELECTRICAL

- Insulate any exposed electrical wiring (using heat shrink tubing or electrical tape) to prevent dangerous short circuits. Take maximum care in wiring, connecting and insulating cables. Make sure cables are always connected securely. Check connectors for if they become loose. And if so, reconnect them securely. Never use RC models with damaged wires. A damaged wire is extremely dangerous, and can cause short-circuits resulting in fire. Please have wires repaired at your local hobby shop.
- Low battery power will result in loss of control. Loss of control can occur due to a weak battery in either the transmitter or the receiver. Weak running battery may also result in an out of control car if your car's receiver power is supplied by the running battery. Stop operation immediately if the car starts to slow down.
- When not using RC model, always disconnect and remove battery.
- DO NOT disassemble battery or cut battery cables. If the running battery short-circuits, approximately 300W of electricity can be discharged, leading to fire or burns. Never disassemble battery or cut battery cables.
- Use a recommended charger for the receiver and transmitter batteries and follow the instructions correctly. Over-charging, incorrect charging, or using inferior chargers can cause the batteries to become dangerously hot. Recharge battery when necessary. Continual recharging may damage battery and, in the worst case, could build up heat leading to fire. If battery becomes extremely hot during recharging, please ask your local hobby shop for check and/or repair and/or replacement.
- Regularly check the charger for potential hazards such as damage to the cable, plug, casing or other defects. Ensure that any damage is rectified before using the charger again. Modifying the charger may cause short-circuit or overcharging leading to a serious accident. Therefore DO NOT modify the charger.
- Always unplug charger when recharging is finished.
- DO NOT recharge battery while battery is still warm. After use, battery retains heat. Wait until it cools down before charging.
- DO NOT allow any metal part to short circuit the receiver batteries or other electrical/electronic device on the model.
- Immediately stop running if your RC model gets wet as may cause short circuit.
- Please dispose of batteries responsibly. Never put batteries into fire.

R/C & BUILDING TIPS

- Make sure all fasteners are properly tightened. Check them periodically.
- Make sure that chassis screws DO NOT protrude from the chassis.
- For the best performance, it is very important that great care is taken to ensure the free movement of all parts.
- Clean all ball-bearings so they move very easily and freely.
- Tap or pre-thread the plastic parts when threading screws.
- Self-tapping screws cut threads into the parts when being tightened. DO NOT use excessive force when tightening the self-tapping screws because you may strip out the thread in the plastic. We recommended you stop tightening a screw when you feel some resistance.
- Ask your local hobby shop for any advice.

Please support your local hobby shop. We at XRAY Model Racing Cars support all local hobby dealers. Therefore we ask you, if at all possible, to purchase XRAY products at your hobby dealer and give them your support like we do. If you have difficulty finding XRAY products, please check out www.teamxray.com to get advice, or contact us via email at info@teamxray.com, or contact the XRAY distributor in your country.

WARRANTY

XRAY guarantees this model kit to be free from defects in both material and workmanship within 30 days of purchase. The total monetary value under warranty will in no case exceed the cost of the original kit purchased. This warranty does not cover any components damaged by use or modification or as a result of wear. Part or parts missing from this kit must be reported within 30 days of purchase. No part or parts will be sent under warranty without proof of purchase. Should you find a defective or missing part, contact the local distributor. Service and customer support will be provided through local hobby store where you have purchased the kit, therefore make sure to purchase any XRAY products at your local hobby store. This model racing car is considered to be a high-performance racing vehicle. As such this vehicle will be used in an extreme range of conditions and situations, all which may cause premature wear or failure of any component. XRAY has no control over usage of vehicles once they leave the dealer, therefore XRAY can only offer warranty against all manufacturer's defects in materials, workmanship, and assembly at point of sale and before use. No warranties are expressed or implied that cover damage caused by what is considered normal use, or cover or imply how long any model cars' components or electronic components will last before requiring replacement.

Due to the high performance level of this model car you will need to periodically maintain and replace consumable components. Any and all warranty coverage will not cover replacement of any part or component damaged by neglect, abuse, or improper or unreasonable use. This includes

but is not limited to damage from crashing, chemical and/or water damage, excessive moisture, improper or no maintenance, or user modifications which compromise the integrity of components. Warranty will not cover components that are considered consumable on RC vehicles. XRAY does not pay nor refund shipping on any component sent to XRAY or its distributors for warranty. XRAY reserves the right to make the final determination of the warranty status of any component or part.

Limitations of Liability

XRAY makes no other warranties expressed or implied. XRAY shall not be liable for any loss, injury or damages, whether direct, indirect, special, incidental, or consequential, arising from the use, misuse, or abuse of this product and/or any product or accessory required to operate this product. In no case shall XRAY's liability exceed the monetary value of this product.

Take adequate safety precautions prior to operating this model. You are responsible for this model's assembly and safe operation.

Disregard of the any of the above cautions may lead to accidents, personal injury, or property damage. XRAY MODEL RACING CARS assumes no responsibility for any injury, damage, or misuse of this product during assembly or operation, nor any addictions that may arise from the use of this product.

All rights reserved.

QUALITY CERTIFICATE

XRAY MODEL RACING CARS uses only the highest quality materials, the best compounds for molded parts and the most sophisticated manufacturing processes of TQM (Total Quality Management). We guarantee that all parts of a newly-purchased kit are manufactured with the highest regard to quality. However, due to the many factors inherent in model racecar competition, we

cannot guarantee any parts once you start racing the car. Products which have been worn out, abused, neglected or improperly operated will not be covered under warranty.

We wish you enjoyment of this high-quality and high-performance RC car and wish you best success on the track!

In line with our policy of continuous product development, the exact specifications of the kit may vary. In the unlikely event of any problems with your new kit, you should contact the model shop where you purchased it, quoting the part number.

We do reserve all rights to change any specification without prior notice. All rights reserved.

TOOLS REQUIRED



Combination Pliers (HUDY #189020)

Side Cutters (HUDY #189010)

Pocket Hobby Knife (HUDY #188981)

Special Tool for Turnbuckles & Nuts (HUDY #181090)

Turnbuckle Wrench 4mm (HUDY #181040)

Turnbuckle Wrench 3mm (HUDY #181030)

Tweezer

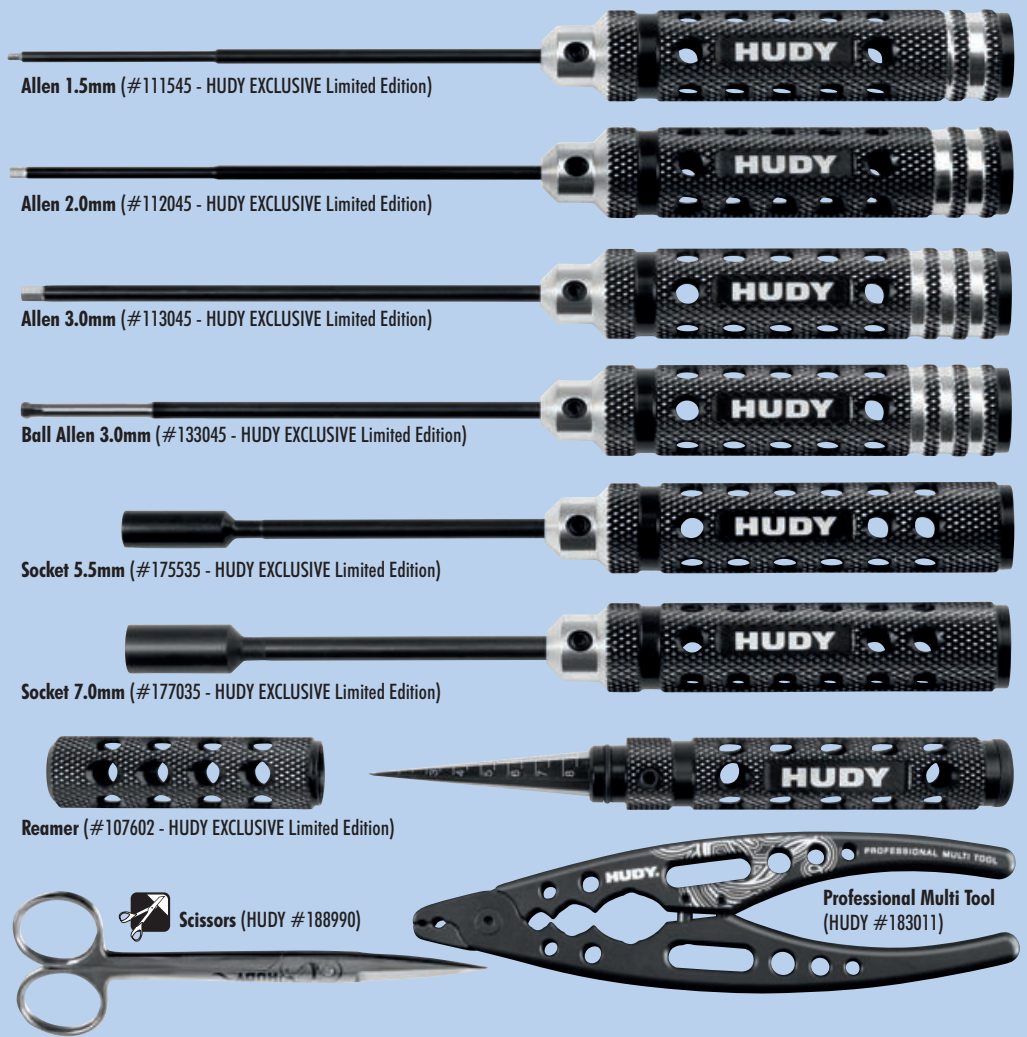

Allen 1.5mm (#111545 - HUDY EXCLUSIVE Limited Edition)

Allen 2.0mm (#112045 - HUDY EXCLUSIVE Limited Edition)

Allen 3.0mm (#113045 - HUDY EXCLUSIVE Limited Edition)

Ball Allen 3.0mm (#133045 - HUDY EXCLUSIVE Limited Edition)

Socket 5.5mm (#175535 - HUDY EXCLUSIVE Limited Edition)

Socket 7.0mm (#177035 - HUDY EXCLUSIVE Limited Edition)

Reamer (#107602 - HUDY EXCLUSIVE Limited Edition)

Scissors (HUDY #188990)

Professional Multi Tool (HUDY #183011)

INCLUDED

* Kit includes smaller but sufficient amount of oil and grease to build the car.

350cSt (#106335) HUDY Premium Silicone Oils

500.000cSt (#106650) HUDY Premium Silicone Oils



(HUDY #106210) Premium Graphite Grease



EQUIPMENT REQUIRED

<p>Transmitter</p>	<p>Receiver</p>	<p>Speed Controller</p>	<p>Steering Servo</p>
<p>Electric Motor</p>	<p>Pinion Gear with Setscrew</p>	<p>LiPo Battery</p>	<p>Battery Charger</p>
<p>Lexan™ Paint</p>	<p>Wheels & Tires & Inserts (HUDY #803041 SLICK PRECUT)</p>	<p>190mm Bodyshell</p>	<p>Double-sided Tape (HUDY #107875)</p>
<p>Fibre Tape (HUDY #107870)</p>	<p>Bearing Oil (HUDY #106230)</p>	<p>Threadlock</p>	<p>CA glue</p>

BUILD TIPS & NOTES



Alexander Hagberg (Factory Driver)

When a QR CODE is found in the instruction manual, scan the code to be directed to an online video that explains that feature or adjustment in more detail. Make sure to watch all of the instructional videos to get the most performance out of your car.

VIDEO TECH TIP



NOTE!

Please note that the videos are made specifically for the X4, but will contain very good information that may apply to the X4F as well.



SAMPLE OF OPTIONAL PARTS

#30XXX	TYPE1	OPTION 1
#30XXX	TYPE1	OPTION 2
#30XXX	TYPE1	INCLUDED
#30XXX	TYPE1	OPTION 3

XRAY offers wide range of OPTIONAL tuning parts which are listed in a table like this. Please refer to the exploded view of each main section to verify which part is included in the kit while all other parts are available only as an optional part and must be purchased separately.

COLOR INDICATIONS

At the beginning of each section is an exploded view of the parts to be assembled. There is also a list of all the parts and part numbers that are related to the assembly of that section.

The part descriptions are color-coded to make it easier for you to identify the source of a part. Here are what the different colors mean:

- 304911** **STYLE A** - indicates parts that are included in the bag marked for the section.
- 301017** **STYLE B** - indicates parts that are included in the box.
- 304902** **STYLE C** - indicates parts that are already assembled from previous steps.
- 301080** **STYLE D** - indicates parts that are optional.

CHASSIS PREPARATION



VIDEO TECH TIP



CHASSIS PREPARATION

To protect and seal edges of graphite parts, sand edges smooth and then apply CA glue.

Do this for: chassis edges and countersunk holes.

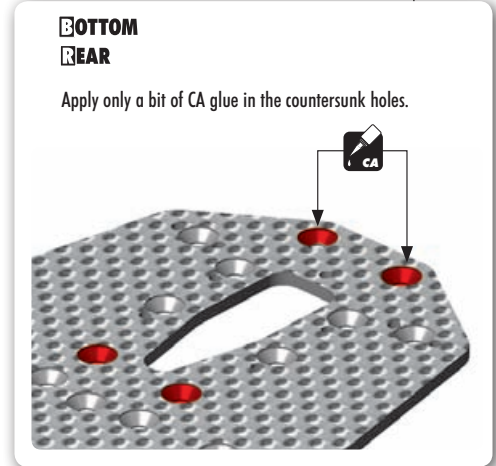
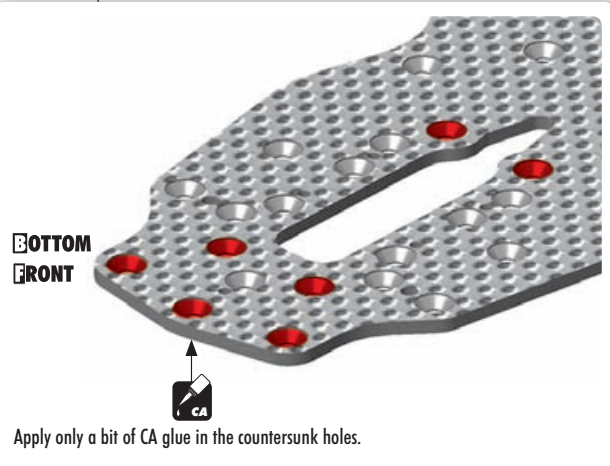
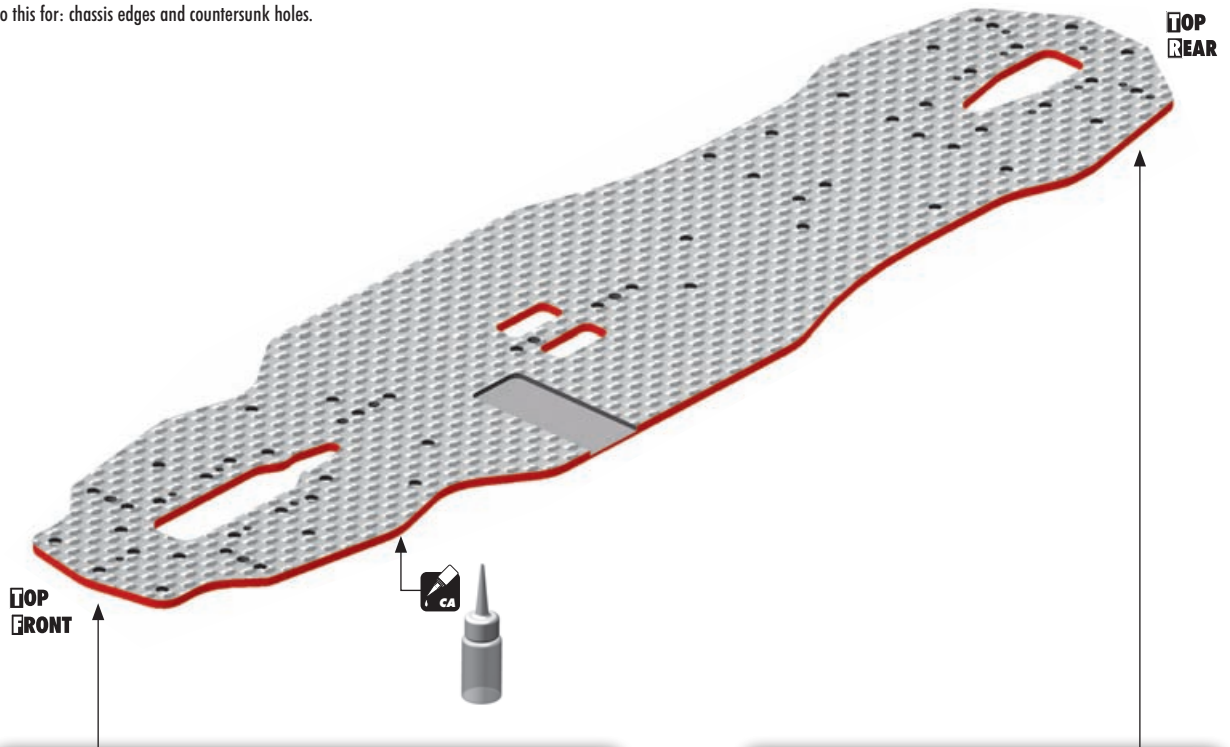

1. GEAR DIFFERENTIAL

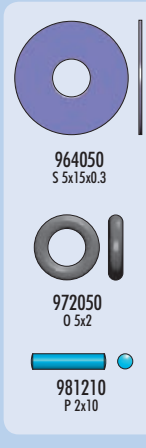

NOTE ORIENTATION

STEP 4 DETAIL
Use tweezers to insert pin.

If the diff is not turning freely after assembly, use thin sand paper to lightly polish the surface.

TIP

CUTAWAY VIEW



#304932 OPTION
GRAPHITE GEAR DIFF BEVEL & SATELLITE GEARS (2+4)

If the cross does not enter into the diff freely, use fine sand paper to lightly polish the ends of the cross.

INITIAL SETTING
500.000cSt

TIP
Fill differential up to the top of the diff pin. DO NOT fill the diff to the top of the housing.

TO ENSURE YOU HAVE THE SAME AMOUNT OF OIL FROM REBUILD TO REBUILD, DO THE FOLLOWING:

VIDEO TECH TIP
REAR DIFFERENTIAL

#107865
HUDY Ultimate Digital Pocket Scale 300g ± 0.01g

1 Put the diff (without oil) on the scale and check the weight (approximately 12.10g)

2 Slowly pour oil into the diff and watch the weight. Add 1.50g of oil into the diff. The approximate weight of the diff including oil is 13.60g.

$12.10g + 1.50g = 13.60g$

TIPS FOR DIFFERENTIALS

- 100.000cSt (HUDY #106610)
- 150.000cSt (HUDY #106615)
- 200.000cSt (HUDY #106620)
- 300.000cSt (HUDY #106630)
- 500.000cSt (HUDY #106650) **INITIAL SETTING**
- 1 000.000cSt (HUDY #106692)
- 2 000.000cSt (HUDY #106694)

If softer oil is used, the car has better rotation, but traction decreases.

SOFTER

↑

HARDER

↓

If harder oil is used, the car has more forward traction and is more stable, but rotation decreases.

TIP To make sure that all the air is removed from the diff oil, we recommend using the HUDY Air Vac.



#104002 OPTION
HUDY AIR VAC – VACUUM PUMP

1. GEAR DIFFERENTIAL

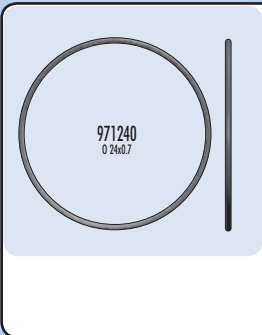

After disassembling the gear diff, the large O-ring may have an increased size and may be more difficult to re-install. We recommend either inserting the old O-ring carefully in the diff cover, or installing a new O-ring if the old one cannot be made to fit properly.



903258
SFH M2.5x8

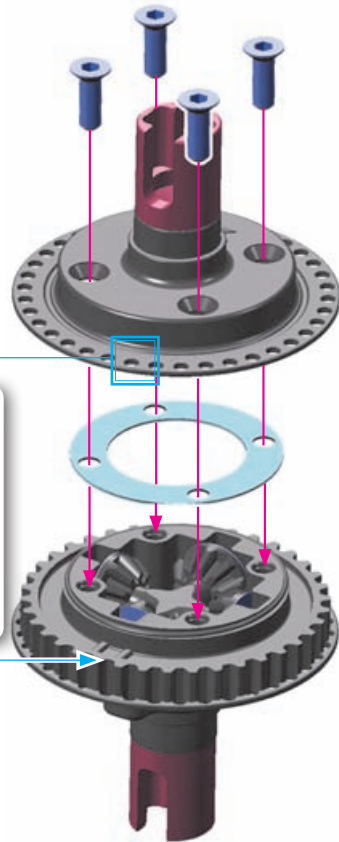
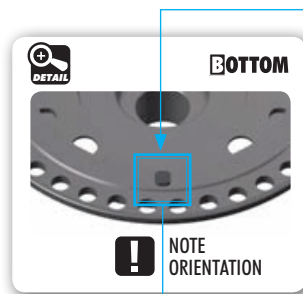

Tighten the screws equally but DO NOT tighten them completely.



Finish tightening in this order.

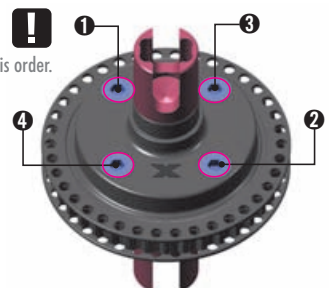

941015
BB 10x15x4

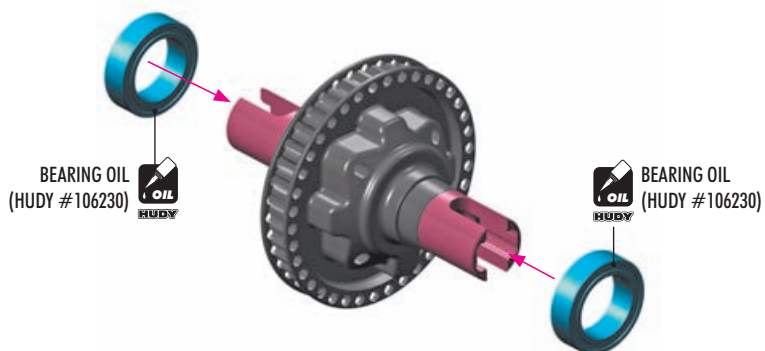

2. FRONT & REAR SUSPENSION

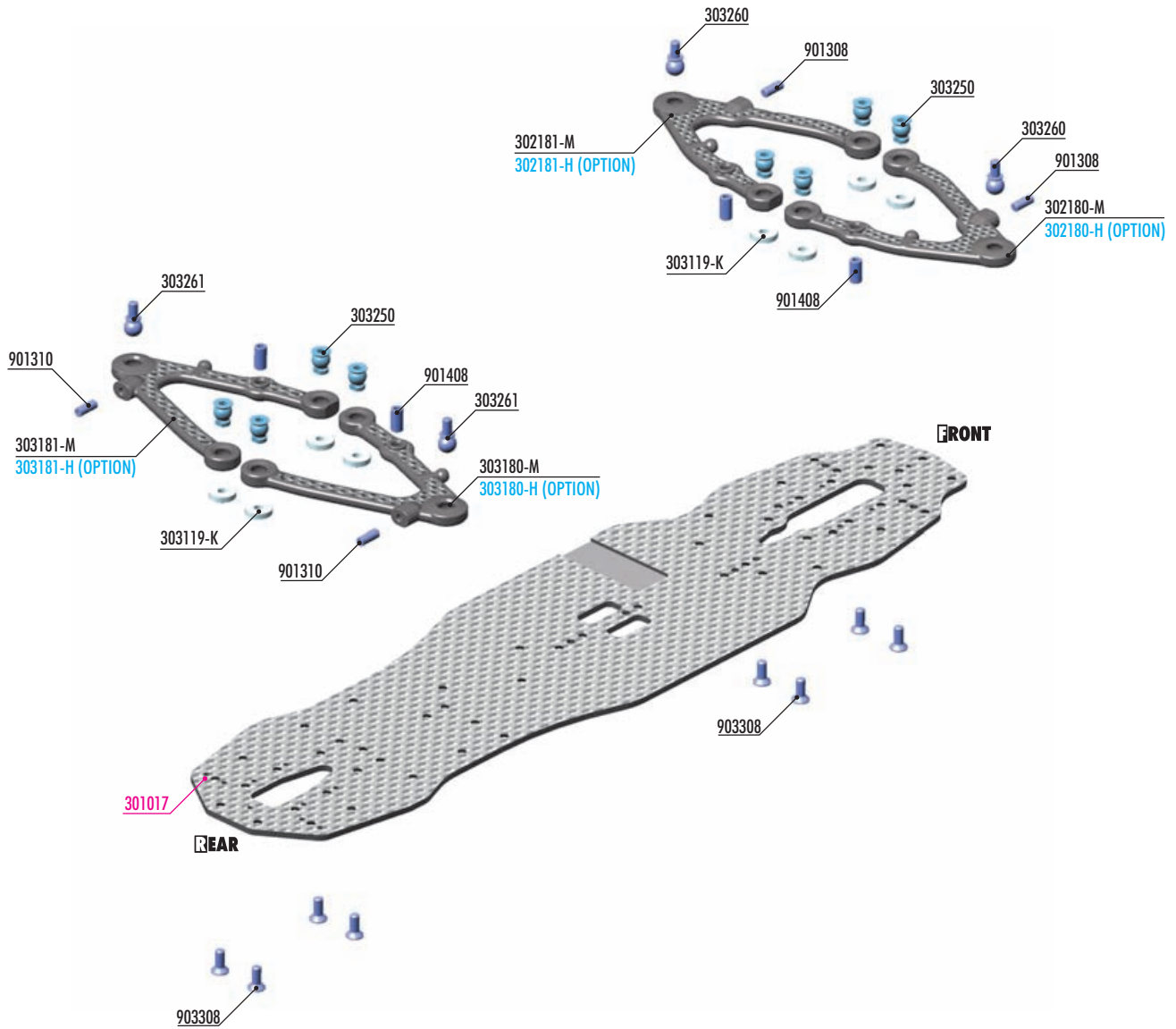

 #302121
FRONT ROLL-CENTER SPACER (2)



 #302122
REAR ROLL-CENTER SPACER (2)



FRONT LOWER ARMS			
#302181-M	LEFT	MEDIUM	INCLUDED
#302180-M	RIGHT	MEDIUM	INCLUDED
#302181-H	LEFT	HARD	OPTION
#302180-H	RIGHT	HARD	OPTION



REAR LOWER ARMS			
#303181-M	LEFT	MEDIUM	INCLUDED
#303180-M	RIGHT	MEDIUM	INCLUDED
#303181-H	LEFT	HARD	OPTION
#303180-H	RIGHT	HARD	OPTION



BAG

02

302180-M	X4 COMPOSITE CFF™ CARBON-FIBER FUSION FRONT LOWER ARM - MEDIUM - RIGHT
302181-M	X4 COMPOSITE CFF™ CARBON-FIBER FUSION FRONT LOWER ARM - MEDIUM - LEFT
303119-K	ALU SHIM 3x9x2.0MM - BLACK (10)
303180-M	X4 COMPOSITE CFF™ CARBON-FIBER FUSION REAR LOWER ARM - MEDIUM - RIGHT
303181-M	X4 COMPOSITE CFF™ CARBON-FIBER FUSION REAR LOWER ARM - MEDIUM - LEFT
303250	X4 LOWER ARM BALL UNIVERSAL 6.0MM WITH HEX - HUDY SPRING STEEL™ (2)
303260	X4 PIVOT BALL 6.0MM WITH M3x5.5MM THREAD - HUDY SPRING STEEL™ (2)
303261	X4 PIVOT BALL 6.0MM WITH M3x6.5MM THREAD - HUDY SPRING STEEL™ (2)

901308	HEX SCREW SB M3x8 (10)
901310	HEX SCREW SB M3x10 (10)
901408	HEX SCREW SB M4x8 (10)
903308	HEX SCREW SFH M3x8 (10)

301017 X4F GRAPHITE CHASSIS 2.2MM

2. FRONT & REAR SUSPENSION

REAR SUSPENSION ARMS

LEFT **RIGHT**

NOTE ORIENTATION (x3)

IMPORTANT 6.5mm Thread REAR SUSPENSION ARMS

TIP Install the pivot balls with Professional Multi Tool (HUDY #183011).

NOTE ORIENTATION Press straight

- 901310 SB M3x10
- 901408 SB M4x8

VIDEO TECH TIP

LOWER ARMS

REAR SUSPENSION ARMS

LEFT = RIGHT

4x8mm

3x10mm

! Make sure to use 10mm set screw for rear arms.

5.0mm

! Make sure to not overtighten this value.

2.6mm

FRONT SUSPENSION ARMS

LEFT **RIGHT**

NOTE ORIENTATION (x3)

IMPORTANT 5.5mm Thread FRONT SUSPENSION ARMS

TIP Install the pivot balls with Professional Multi Tool (HUDY #183011).

NOTE ORIENTATION Press straight

2. FRONT & REAR SUSPENSION



901308
SB M3x8



901408
SB M4x8

FRONT SUSPENSION ARMS

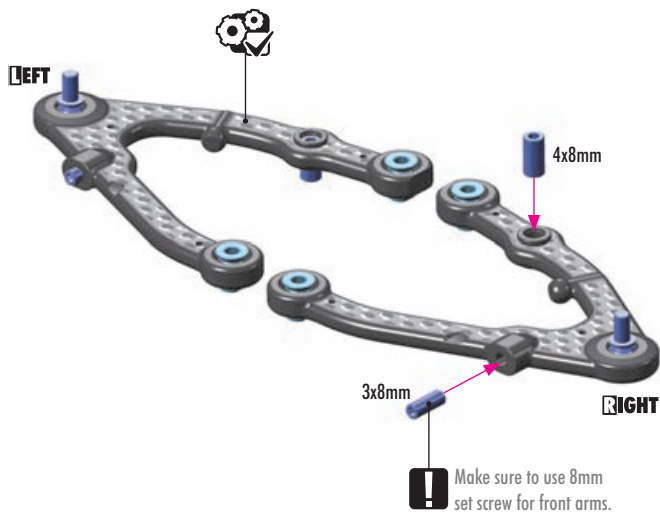

L=R LEFT = RIGHT

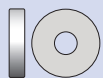
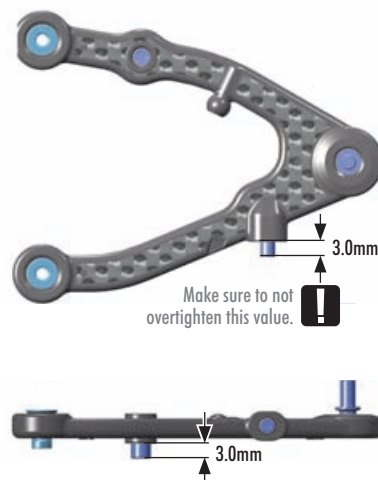

303119-K
SHIM 3x9x2



903308
SFH M3x8



#302121
FRONT ROLL-CENTER SPACER (2)



#302122
REAR ROLL-CENTER SPACER (2)



NOTE ORIENTATION
Front Arms.

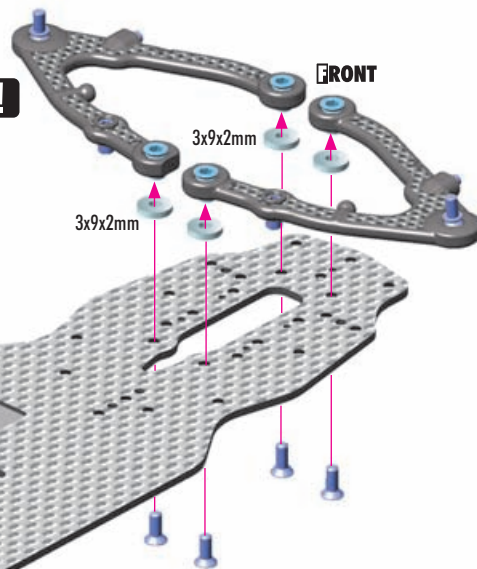

NOTE ORIENTATION
Rear Arms.

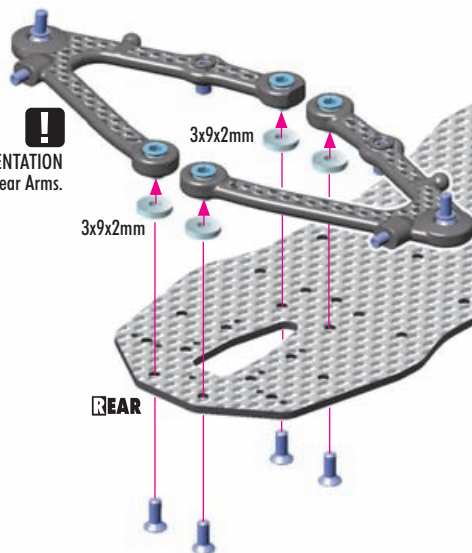

FRONT LOWER ARMS

#302181-M	LEFT	MEDIUM	INCLUDED
#302180-M	RIGHT	MEDIUM	INCLUDED
#302181-H	LEFT	HARD	OPTION
#302180-H	RIGHT	HARD	OPTION



REAR LOWER ARMS

#303181-M	LEFT	MEDIUM	INCLUDED
#303180-M	RIGHT	MEDIUM	INCLUDED
#303181-H	LEFT	HARD	OPTION
#303180-H	RIGHT	HARD	OPTION



ROLL-CENTER ADJUSTMENT

RAISING THE LOWER ARMS will raise the car's roll center. Raising the lower arms both front and rear will free up the car, and will make it initially more responsive. Side bite will be decreased. A higher roll center is typically recommended for asphalt racing.

LOWERING THE LOWER ARMS will lower the car's roll center. Lowering both the front and rear arms will lock in the car more, and will make it initially less responsive. Side bite will be increased. A lower roll center is typically recommended for carpet racing.

We recommend the **MEDIUM** hardness of the lower suspension arms for asphalt. These arms are more flexible than the H (hard) arms.

For carpet racing and even some high-grip asphalt conditions, we recommend the **HARD** suspension arms.



VIDEO TECH TIP



ROLL-CENTER



CHASSIS ALTERNATIVES

3. CENTRAL TRANSMISSION

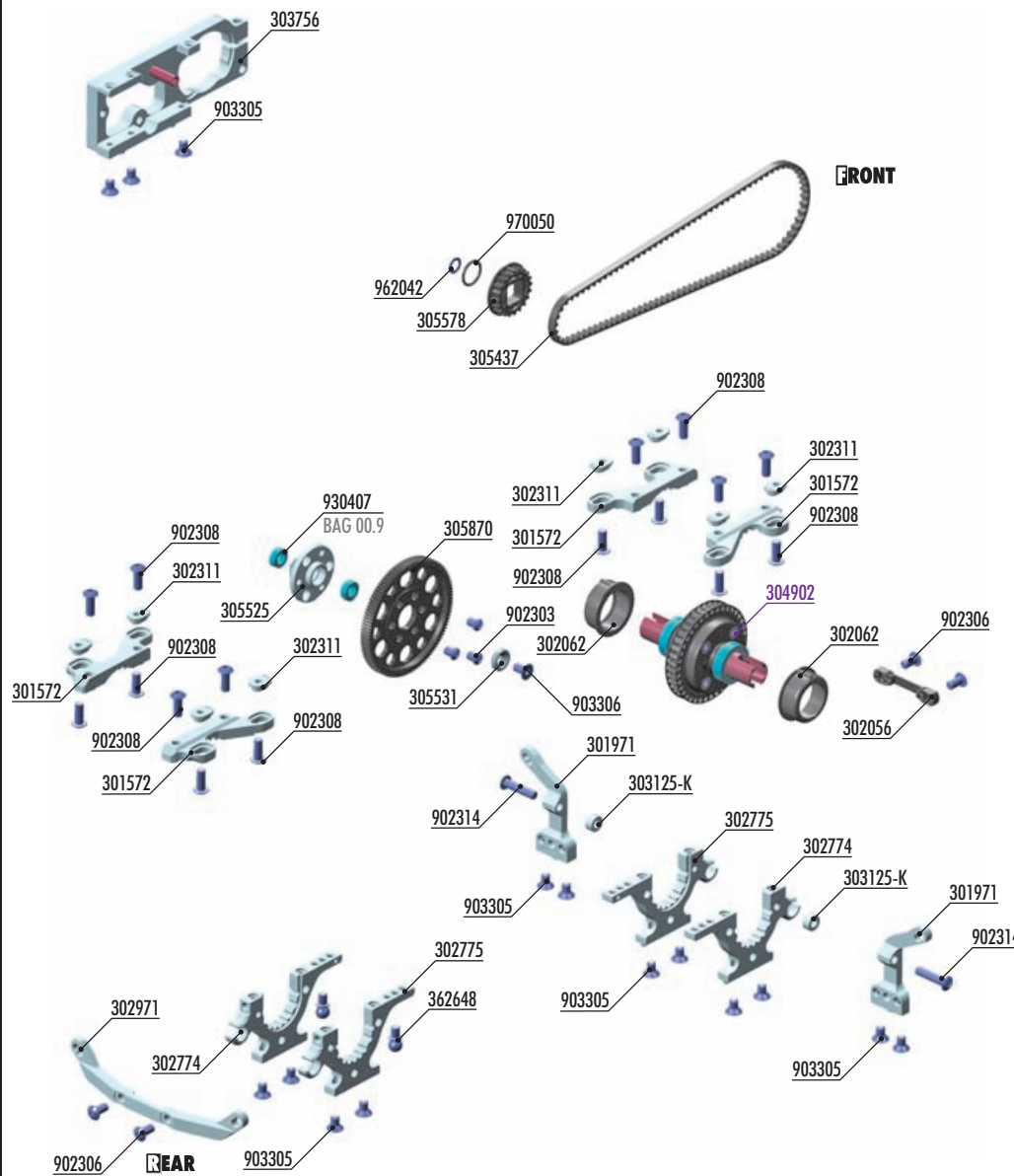

#303768
ALU CHASSIS T-BRACE - 7075 T6
OPTION



#303767
BRASS CHASSIS T-BRACE - 8g
OPTION



OPTION

SPUR GEARS 48P		
#305772	72T / 48P	OPTION
#305776	76T / 48P	OPTION
#305778	78T / 48P	OPTION
#305779	79T / 48P	OPTION
#305781	81T / 48P	OPTION
#305784	84T / 48P	OPTION
#305784-0	84T / 48P	OPTION



OFFSET SPUR GEARS 64P		
#305860	90T / 64P	OPTION
#305862	92T / 64P	OPTION
#305866	96T / 64P	OPTION
#305866-0	96T / 64P	OPTION
#305869	99T / 64P	OPTION
#305870	100T / 64P	INCLUDED
#305870-0	100T / 64P	OPTION
#305874	104T / 64P	OPTION
#305876	106T / 64P	OPTION
#305878	108T / 64P	OPTION
#305880	110T / 64P	OPTION
#305880-0	110T / 64P	OPTION
#305882	112T / 64P	OPTION
#305884	114T / 64P	OPTION



#301574
ALU UPPER CLAMPS - 1.5mm
OPTION



OPTION

ALU CASTER BUSHINGS			
#302310	FRONT 3° / REAR 5.5° or 0.5°	1 Dot	OPTION
#302311	FRONT 4° / REAR 4.5° or 1.5°	2 Dots	INCLUDED
#302312	FRONT 5° / REAR 3.5° or 2.5°	3 Dots	OPTION



OPTION

#305578-0
FIXED PULLEY FOR LAYSHAFT WITH BEARINGS 20T - GRAPHITE (2)



OPTION

#302063-K
ALU ADJUSTMENT BALL-BEARING HUB (2)



BAG

03

- 301572 ALU UPPER CLAMP - SWISS 7075 T6 (L+R)
- 301971 XLP ALU SHOCK TOWER FRONT - SWISS 7075 T6 (L+R)
- 302056 X4 GRAPHITE FRONT SUSPENSION BRACE
- 302062 COMPOSITE ADJUSTMENT BALL-BEARING HUB (4)
- 302311 X4 ALU CASTER BUSHING FRONT 4° / REAR 1.5° - 2 DOTS (4)
- 302774 ALU LOWER BULKHEAD - FRONT R / REAR L - 7075 T6
- 302775 ALU LOWER BULKHEAD - FRONT L / REAR R - 7075 T6
- 302971 XLP ALU SHOCK TOWER REAR - SWISS 7075 T6
- 303125-K ALU SHIM 3x6x3.0MM - BLACK (10)
- 303756 X4F ALU MOTOR MOUNT
- 305437 HIGH-PERFORMANCE DRIVE BELT 3x300MM
- 305525 X4F ALU SOLID LAYSHAFT & BEARINGS
- 305531 X4F ALU SOLID LAYSHAFT WASHER FOR BATTERY BACKSTOP
- 305578 FIXED PULLEY FOR LAYSHAFT WITH BEARINGS 20T (2)

- 305870 OFFSET SPUR GEAR 100T / 64
- 362648 BALL END 4.9MM WITH THREAD 4MM (2)
- 902303 HEX SCREW SH M3x4 SMALL HEAD - STAINLESS (10)
- 902306 HEX SCREW SH M3x6 (10)
- 902308 HEX SCREW SH M3x8 (10)
- 902314 HEX SCREW SH M3x14 (10)
- 903305 HEX SCREW SFH M3x5 (10)
- 903306 HEX SCREW SFH M3x6 (10)
- 930407 BALL-BEARING 4x7x2.5 STEEL SEALED - OIL (2)
- 962042 WASHER S 4x6x0.1 (10)
- 970050 O-RING 5x1 (10)
- 304902 X4 BB GEAR DIFFERENTIAL - SET

Numbers in parentheses () refer to quantities when purchased separately.

XRAY

3. CENTRAL TRANSMISSION



NOTE ORIENTATION FOR ALL PARTS

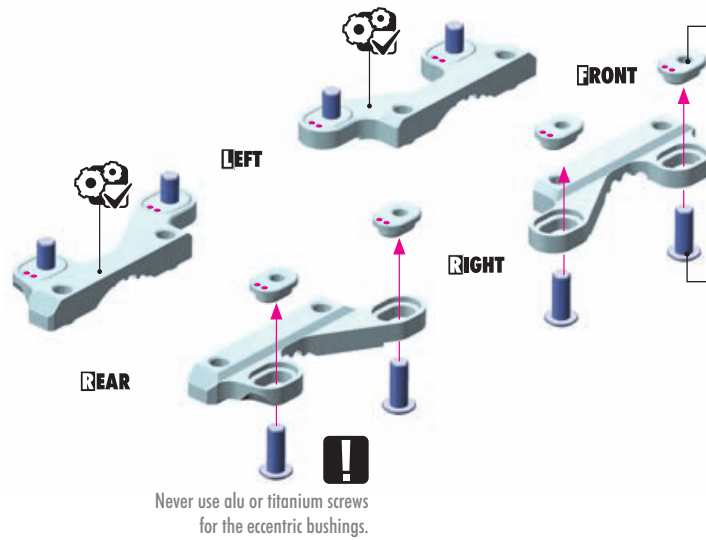

IMPORTANT
All 4 bushings at one end of the car must be installed in the same orientation.

! Never use alu or titanium screws for the eccentric bushings.



The new upper clamps move the inner pivot 1.5mm closer to center. This position lengthens the upper arm and reduces camber gain to free up the car. Mid corner steering improves in long sweepers, and traction rolling is reduced in very high traction carpet conditions. Recommended for large open tracks or high traction carpet tracks.

OPTION	ALU CASTER BUSHINGS		
#302310	FRONT 3° / REAR 5.5° or 0.5°	1 Dot	OPTION
#302311	FRONT 4° / REAR 4.5° or 1.5°	2 Dots	INCLUDED
#302312	FRONT 5° / REAR 3.5° or 2.5°	3 Dots	OPTION

CASTER ADJUSTMENT

FRONT CASTER
For most conditions, a good starting point for front caster set is 4.0°
Increasing front caster will increase steering (mainly on-power), but it will also make the car more difficult to drive and more likely to traction roll.

REAR CASTER
A good starting point for rear caster is 4.5°
More rear caster will increase traction and steering. Less rear caster will increase rotation of the car.

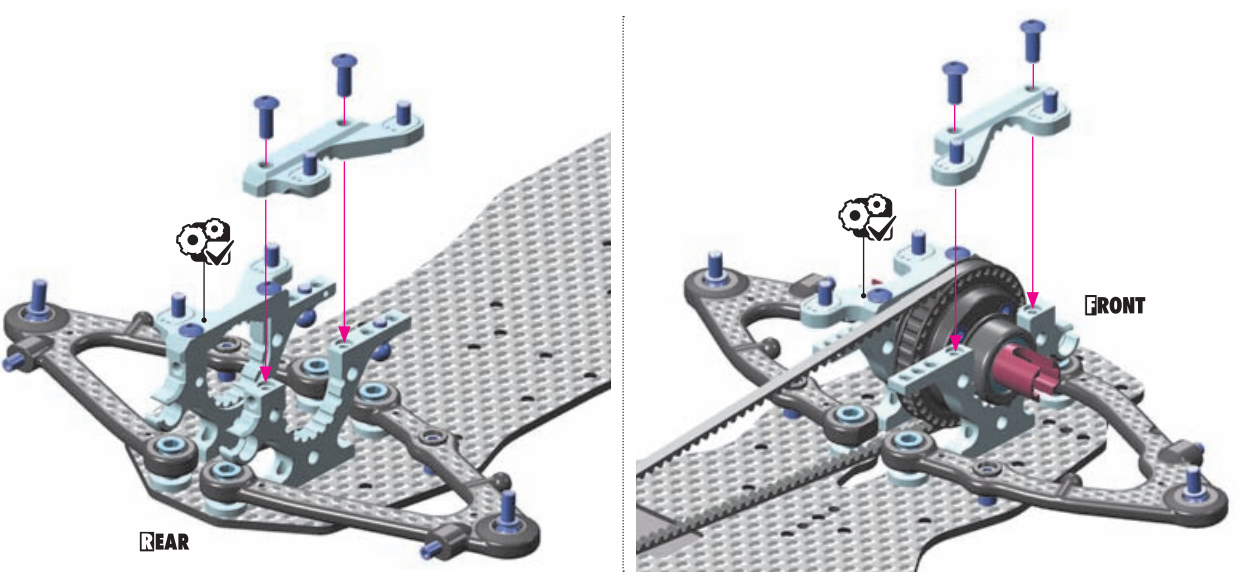
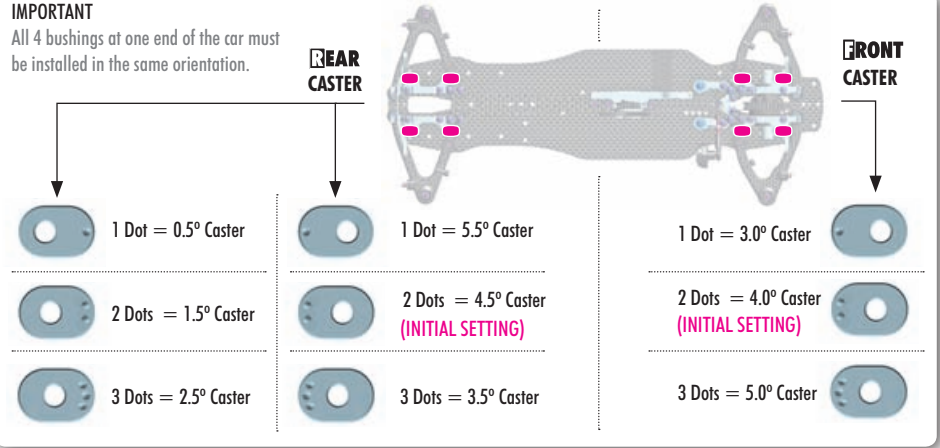

3. CENTRAL TRANSMISSION



FRONT BELT TENSION ADJUSTMENT

Front diff **UPPER** position - tab in bottom notch - provides **more steering**, but **less front traction**

Front diff **LOWER** position - tab in top notch - provides **more front traction**, but makes the car **push on-power**.

Recommended for **medium-high** traction tracks and technical tracks.

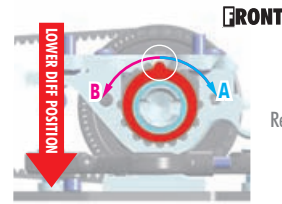
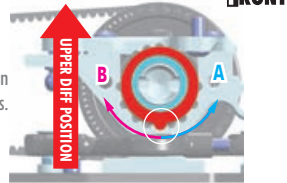

Recommended for **low-traction** tracks.

INITIAL POSITION FOR CARPET/ASPHALT
Place tab in this **BOTTOM NOTCH**

TO LOOSEN REAR BELT: Rotate both front nylon hubs in arrow direction **A**

TO TIGHTEN REAR BELT: Rotate both front nylon hubs in arrow direction **B**



VIDEO TECH TIP



DIFF HEIGHT



BELT TENSION ADJUSTMENT



902303
SH M3x4



930407
BB 4x7x2.5



970050
O 5x1



966081
CH-CLIP 8

1.

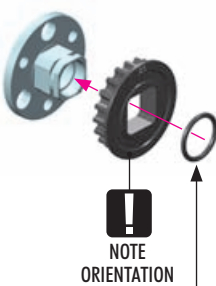

NOTE
ORIENTATION

#966081
CH-CLIP 8 (10)
INCLUDED IN THE
LAST AID BAG

Another alternative to secure the pulley on the layshaft is to use the CH-clip which is included in the "Last Aid" Bag. To mount the clip on the layshaft, you have to use special Snap Ring Pliers.



Snap Ring Pliers
(HUDY #189040)



#305578-0
FIXED PULLEY FOR
LAYSHAFT WITH
BEARINGS 20T
GRAPHITE (2)



2. ALTERNATIVE
64P OFFSET SPUR GEAR
(INITIAL SETTING)

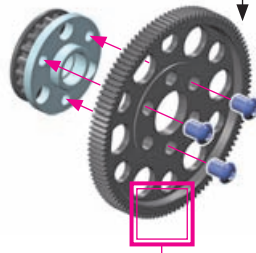

NOTE
ORIENTATION



CUTAWAY VIEW



OFFSET NOTE
ORIENTATION



OFFSET SPUR GEARS 64P

#305860	90T	OPTION
#305862	92T	OPTION
#305866	96T	OPTION
#305866-0	96T	OPTION
#305869	99T	OPTION
#305870	100T	INCLUDED
#305870-0	100T	OPTION
#305874	104T	OPTION
#305876	106T	OPTION
#305878	108T	OPTION
#305880	110T	OPTION
#305880-0	110T	OPTION
#305882	112T	OPTION
#305884	114T	OPTION

2. ALTERNATIVE
48P SPUR GEAR

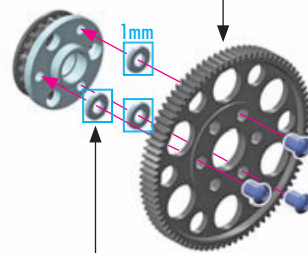

When using XRAY 48P spur gears or aftermarket spur gears without an offset, use the 3x5x1mm shims (#303141 not included) between the gear and layshaft to create the necessary clearance from the top deck.

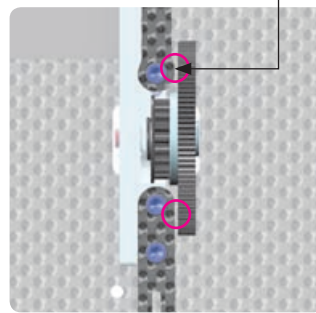

SPUR GEARS 48P

#305772	72T	OPTION
#305776	76T	OPTION
#305778	78T	OPTION
#305779	79T	OPTION
#305781	81T	OPTION
#305784	84T	OPTION
#305784-0	84T	OPTION

3.



BEARING OIL
(HUDY #106230)

3. CENTRAL TRANSMISSION



903306
SFH M3x6



962042
S 4x6x0.1



VIDEO TECH TIP



BELT TENSION
ADJUSTMENT

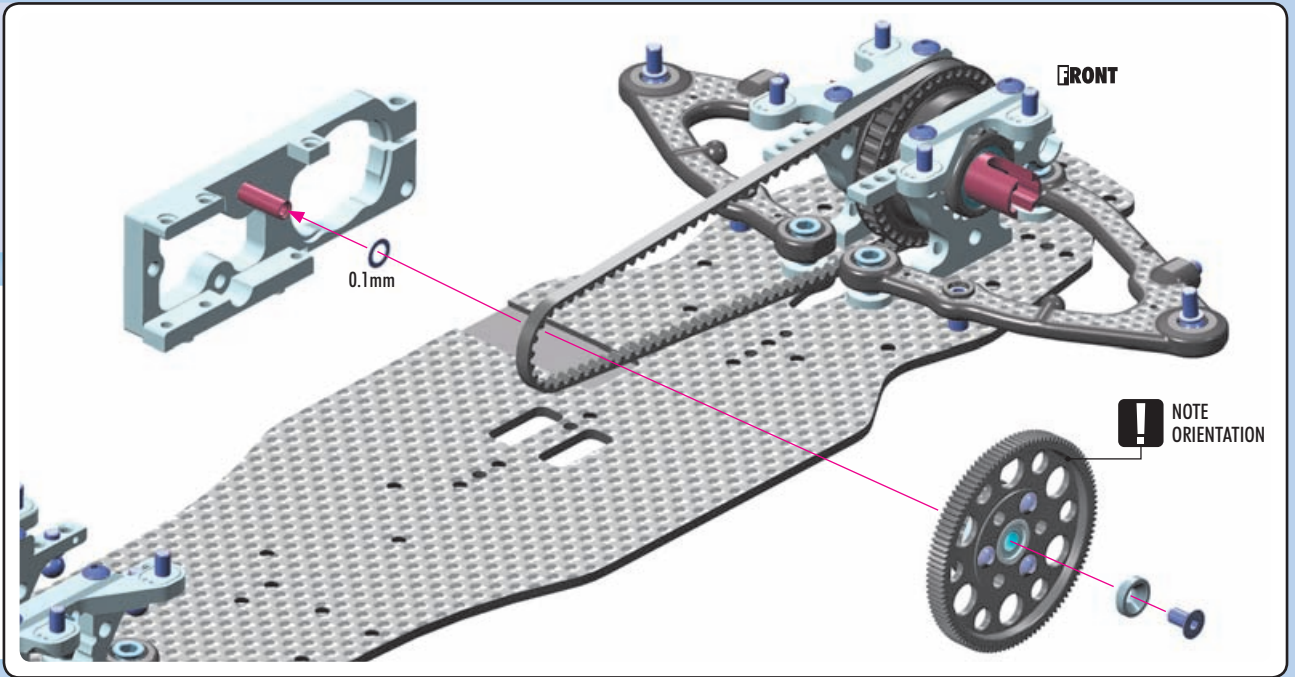

903305
SFH M3x5

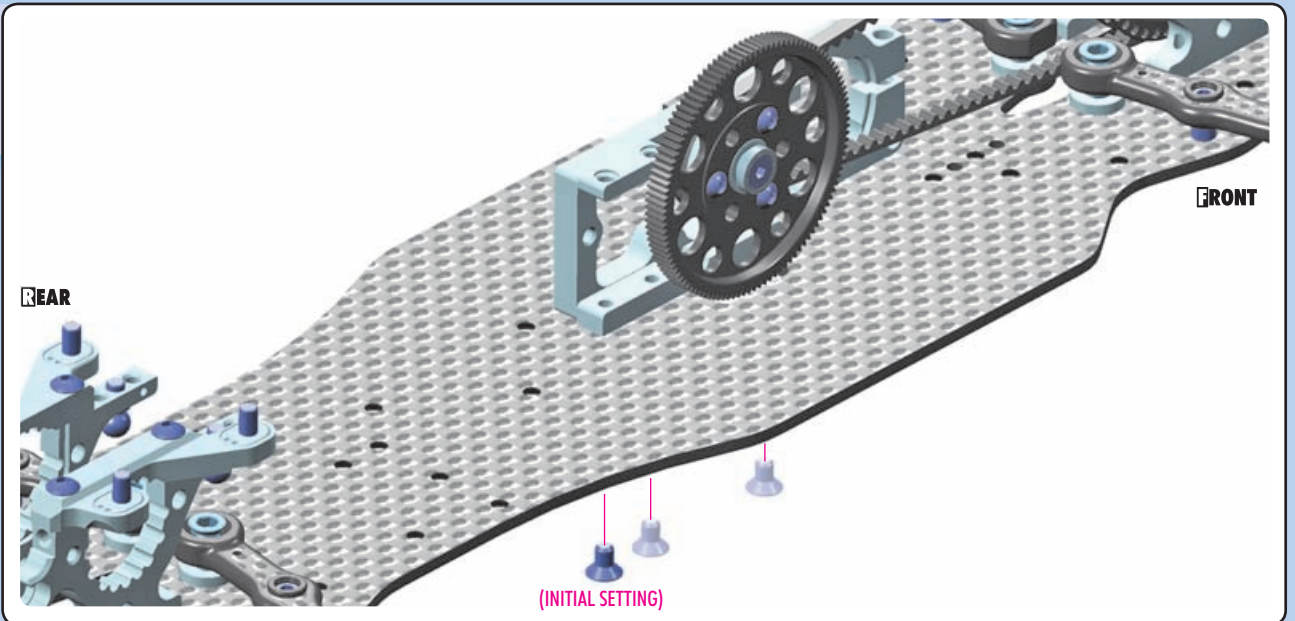

MOTOR MOUNT FLEX ADJUSTMENT

SOFT (INITIAL SETTING)

Use only the rearmost screw to attach the motor mount as shown below. This allows more central chassis flex and will improve traction, especially on power. Rear grip will improve through the entire corner. This setting is recommended for low to medium traction conditions, both on asphalt and carpet.

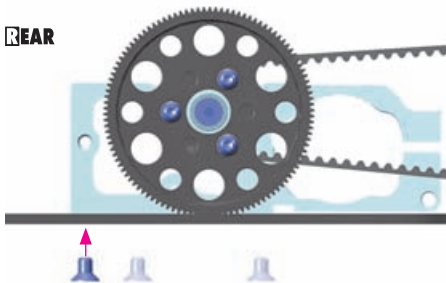

MEDIUM

Use the two rear screws to attach the motor mount as shown, and DO NOT install the very front screw. This configuration is a compromise between stability and initial response. The additional rear screw improves stability with a slight reduction in steering.

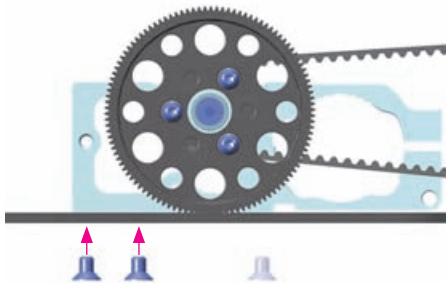

STIFF

Use all three screws to attach the motor mount for maximum stability. Recommended for high traction surfaces.

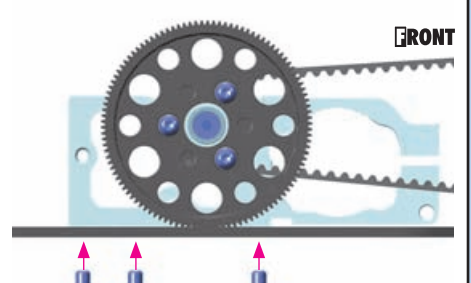

3. CENTRAL TRANSMISSION

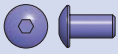

902306
SH M3x6

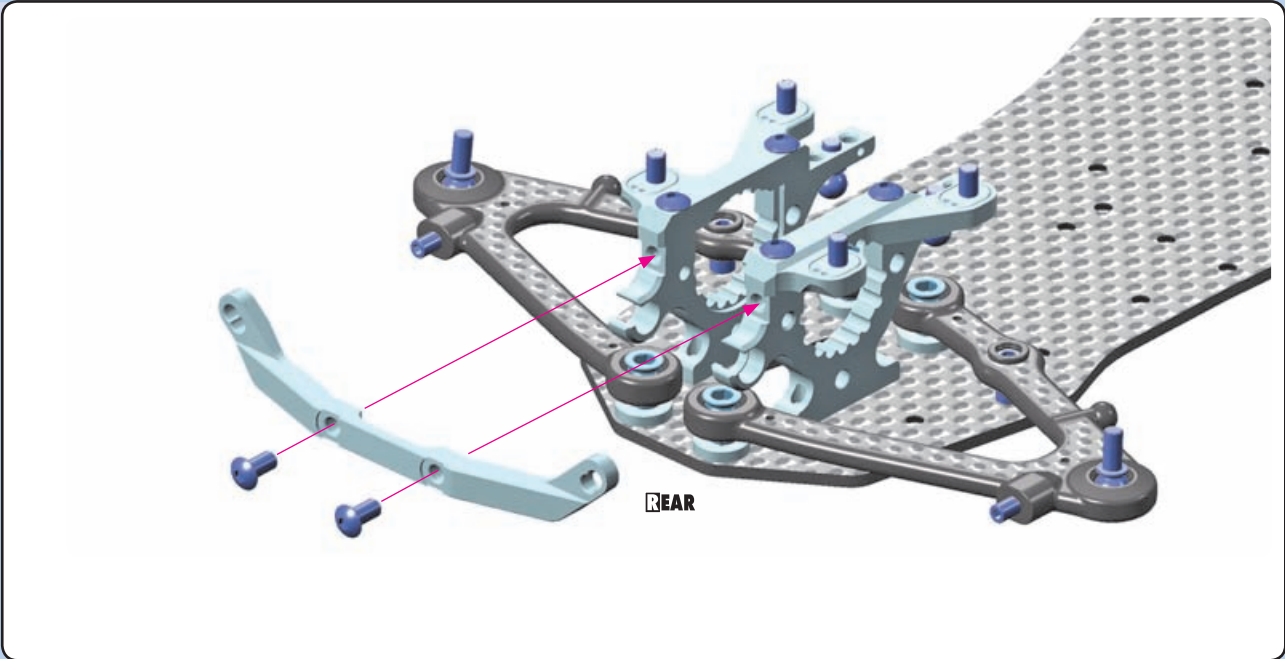

REAR



303125-K
SHIM 3x6x3



902314
SH M3x14



903305
SFH M3x5

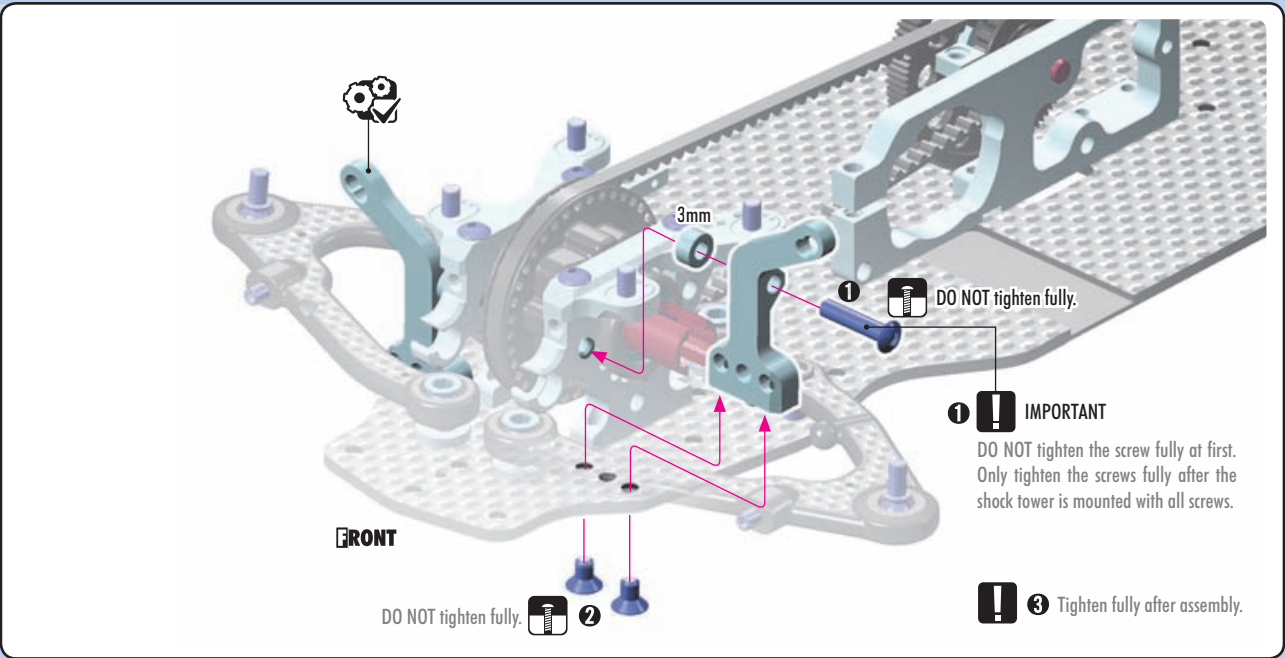

FRONT

DO NOT tighten fully. 2

1 DO NOT tighten fully.

1 **IMPORTANT**

DO NOT tighten the screw fully at first. Only tighten the screws fully after the shock tower is mounted with all screws.

3 Tighten fully after assembly.

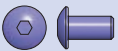

902306
SH M3x6

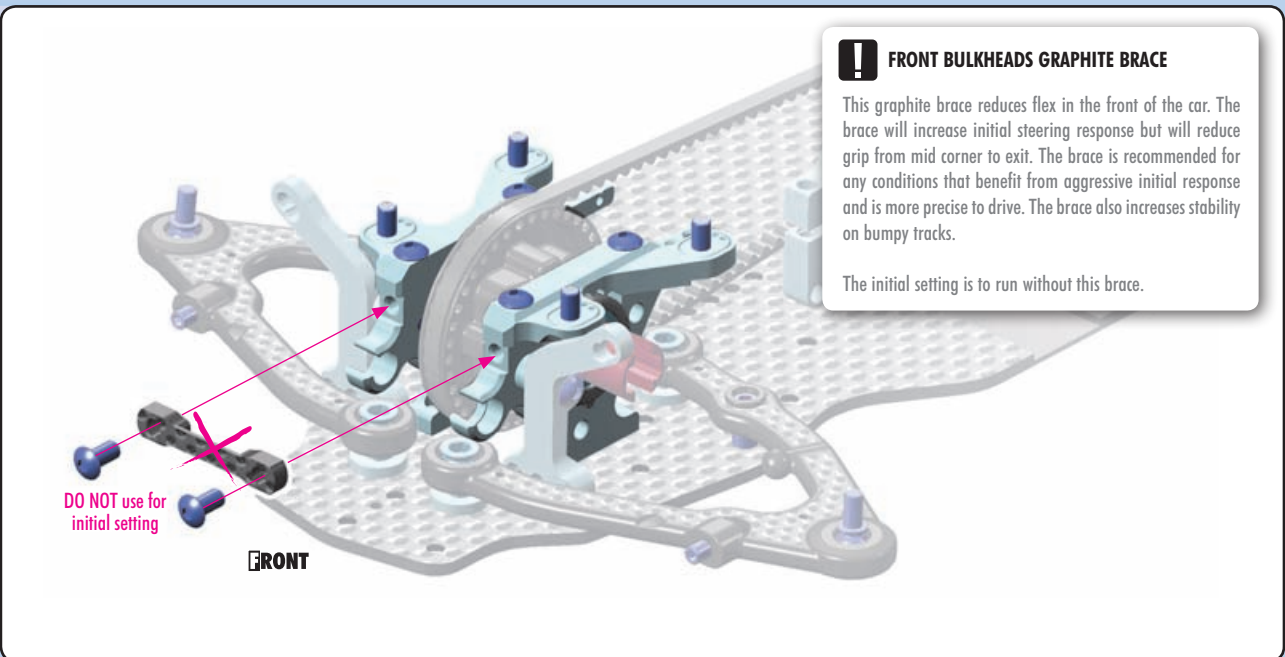

DO NOT use for initial setting

FRONT

FRONT BULKHEADS GRAPHITE BRACE

This graphite brace reduces flex in the front of the car. The brace will increase initial steering response but will reduce grip from mid corner to exit. The brace is recommended for any conditions that benefit from aggressive initial response and is more precise to drive. The brace also increases stability on bumpy tracks.

The initial setting is to run without this brace.

3. CENTRAL TRANSMISSION



303121-K
SHIM 3x6x0.5



903305
SFH M3x5



903306
SFH M3x6



OPTION



NOTE ORIENTATION

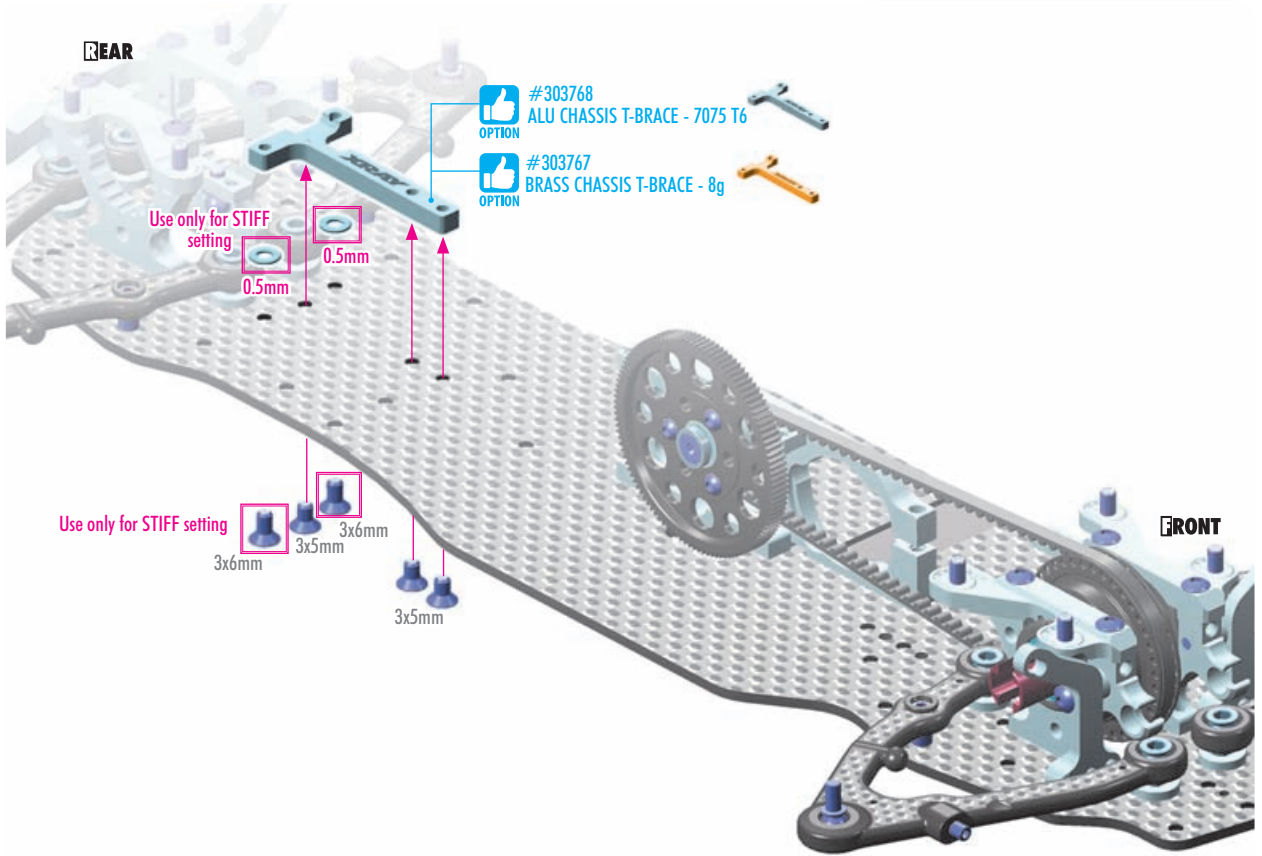
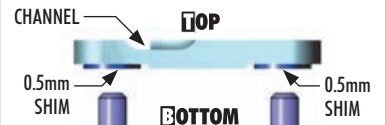

CHASSIS FLEX ADJUSTMENT

The brace provides chassis flex adjustment possibilities depending on which screws are connected.

SOFT - NO BRACE

When the brace is not installed, the car will have the most steering and rotation. However, the car will be more difficult to drive as it is less stable. Recommended for medium-high traction conditions and for small, technical tracks with many hairpin corners.

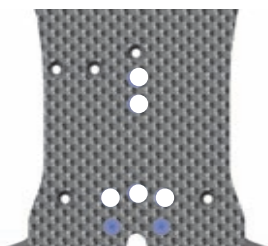

REAR

SOFT - MEDIUM

Install the brace using only the 2 forward bottom centerline screws (as shown). This gives improved on-power stability but still offers great off-power steering and rotation. Recommended for medium-high traction conditions and for small, technical tracks with many hairpin corners.

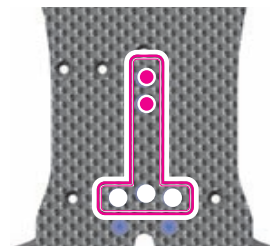

REAR

MEDIUM

Install the brace using all 3 bottom centerline screws (as shown). This gives improved on-power stability and traction, but makes the car push more off-power. Recommended for low- or high-traction conditions where stability and traction is needed.

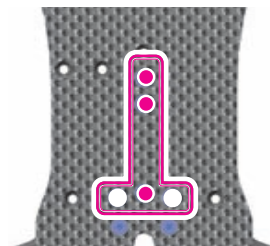

REAR

STIFF

In addition to installing all 3 bottom centerline screws, also install the 2 rear side screws but with 0.5mm shims between the brace and the chassis. This setting gives maximum stability.

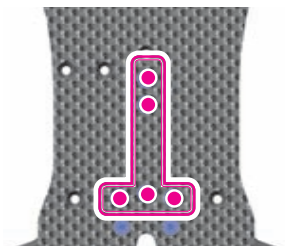

REAR



VIDEO TECH TIP



CHASSIS & TOP DECKS

4. STEERING

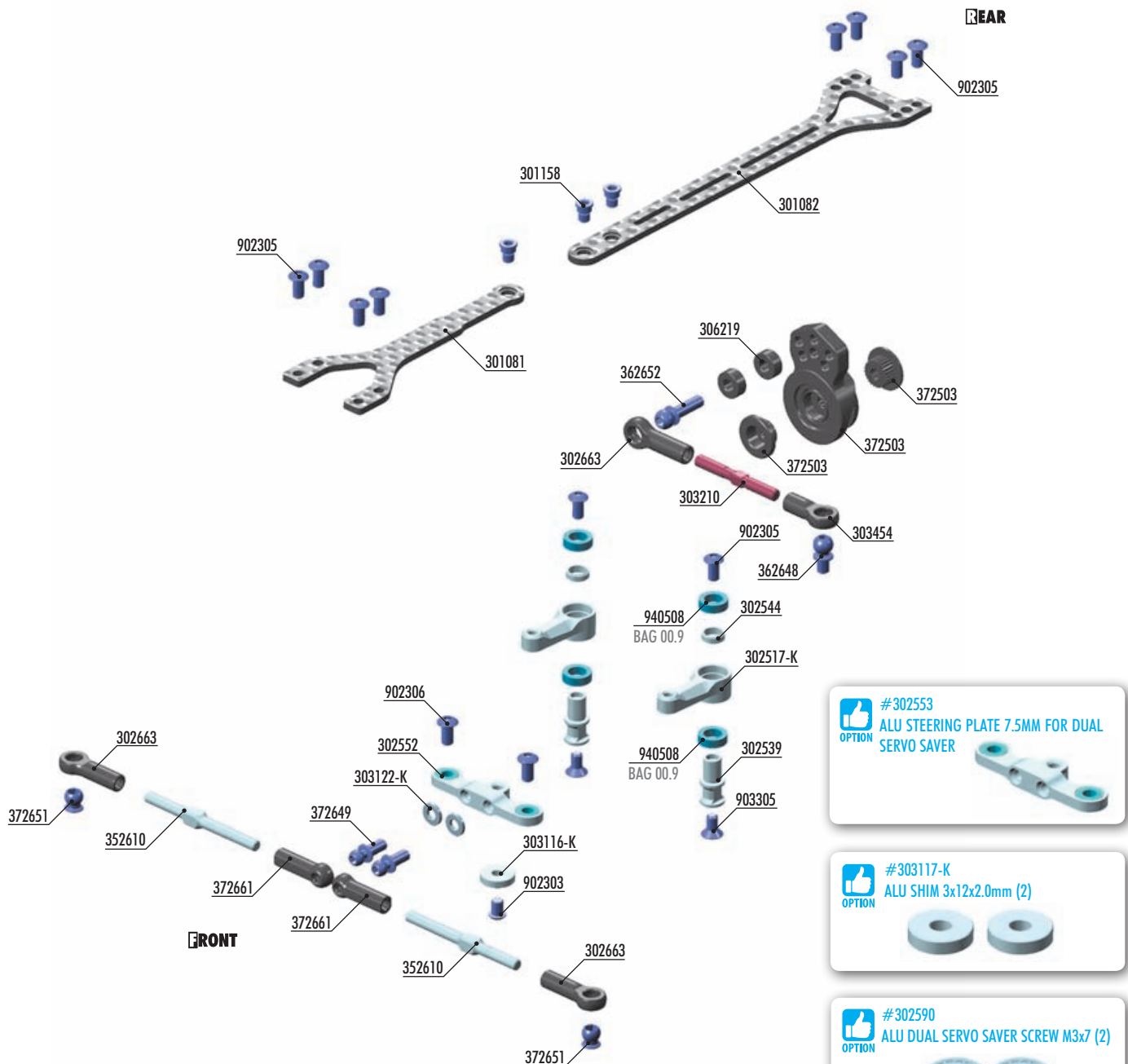

BAG
04

301081	X4F GRAPHITE UPPER DECK - SPLIT FRONT - 2.0mm	352610	ADJ. TURNBUCKLE M3 L/R 45mm - SPRING STEEL - V3 (2)
301082	X4F GRAPHITE UPPER DECK - SPLIT REAR - 2.0mm	362648	BALL END 4.9mm WITH THREAD 4mm (2)
301158	TOP DECK HEX SCREW M3x5.5 - HUDY SPRING STEEL™ (2)	362652	BALL END 4.9mm WITH THREAD 10mm (2)
302517-K	X4 ALU DUAL STEERING ARM - BLACK + BALL-BEARINGS (2)	372503	COMPOSITE SERVO SAVER - X-STIFF - SET - V2
302539	X4 ALU STEERING POST FOR DUAL SERVO SAVER (2)	372649	BALL END 4.2mm WITH 4mm THREAD (2)
302544	ALU SHIM FOR RADIAL PLAY ADJUSTMENT OF STEERING ARM (2)	372651	PIVOT BALL UNIVERSAL 4.9mm (2)
302552	ALU STEERING PLATE 8.0mm FOR DUAL SERVO SAVER	372661	COMPOSITE STEERING BALL-JOINT OPEN 4.2mm (4)
302663	COMPOSITE BALL JOINT 4.9mm - OPEN - V2 (8)		
303116-K	ALU SHIM 3x10x2.0mm - BLACK (2)	902303	HEX SCREW SH M3x4 SMALL HEAD - STAINLESS (10)
303122-K	ALU SHIM 3x6x1.0mm - BLACK (10)	902305	HEX SCREW SH M3x5 (10)
303210	REAR TURNBUCKLE L/R 26mm - HUDY SPRING STEEL (2)	902306	HEX SCREW SH M3x6 (10)
303454	BALL JOINT 4.9mm - OPEN (4)	903305	HEX SCREW SFH M3x5 (10)
306219	COMPOSITE SET OF SERVO SHIMS (4)	940508	BALL-BEARING 5x8x2.5 RUBBER-SEALED - OILED (2)

Numbers in parentheses () refer to quantities when purchased separately.

4. STEERING

2x
STEERING LINKS

NOTE ORIENTATION
Round ball joint on the long side.

LEFT THREAD **RIGHT THREAD**

2x **L=R**

28mm

OPTION **#302612-0**
ALU ADJ. TURNBUCKLE M3 L/R
39mm ORANGE - SWISS 7075 T6 (2)

OPTION **#302610**
ADJ. TURNBUCKLE L/R 39mm
HUDY SPRING STEEL (2)

1x
SERVO LINK

Adjust servo link to fit your servo.

LEFT THREAD **RIGHT THREAD**

approx. 14.5mm

303116-K
SHIM 3x10x2

902303 SH M3x4 **902306** SH M3x6

940508
BB 5x8x2.5

BEARING OIL (HUDY #106230)

5x8x2.5mm

NOTE ORIENTATION

3x6mm **NOTE ORIENTATION**

3x10x2mm **3x6mm**

3x4mm

BEARING OIL (HUDY #106230)

NOTE ORIENTATION

5x8x2.5mm

OPTION **#302553 ALU STEERING PLATE 7.5MM FOR DUAL SERVO SAVER**

Optional 7.5mm steering plate improves steering from mid corner to exit but reduces initial response. Recommended for high traction carpet or high-speed asphalt tracks.

OPTION **#303117-K**
ALU SHIM 3x12x2.0mm (2)

STEERING LOCK ADJUSTMENT

Steering lock angle is adjusted by the size of the shim which attaches to the bottom of the steering.

The kit includes a 10mm OD shim, which limits the physical steering lock to approx. 26°.

An optional 12mm shim is available, which will limit the physical steering lock to approx. 23°.

More steering lock will increase steering - especially in tight corners - but also reduces cornering speeds and makes the car more difficult to drive.

VIDEO TECH TIP

STEERING SYSTEM

303122-K
SHIM 3x6x1

2x **L=R**

NOTE ORIENTATION (outside)

NOTE ORIENTATION Ball joint open

TIP Install the pivot balls with Professional Multi Tool (HUDY #183011).

4mm THREAD **4.2mm BALL** **1mm**

DO NOT use for initial setting

NOTE ORIENTATION (outside)

NOTE ORIENTATION Ball joint open

IO

306219
SHIM 3x6x2



VIDEO TECH TIP



STEERING SYSTEM

! INITIAL SETTING

H = (24T)
F = (25T)
K = (23T)

TIP Install the pivot balls with Professional Multi Tool (HUDY #183011).

OPTION #302664
COMPOSITE BALL JOINT 4.9mm
UNIDIRECTIONAL - OPEN (4)

For more in-corner steering and better steering response, aluminum servo horns may be used.

OPTION HUDY ALU SERVO HORNS

#293497	KO, Sanwa - 23T
#293498	Hitec - 24T
#293499	Futaba - 25T

OPTION HUDY CLAMP ALU SERVO HORNS

#293404	KO, Sanwa - 23T
#293405	Hitec - 24T
#293406	Futaba - 25T

OPTION HUDY ALU SERVO HORNS

#293501	KO, Sanwa - 23T
#293502	Hitec - 24T
#293503	Futaba - 25T

OPTION HUDY CLAMP ALU SERVO HORNS

#293407	KO, Sanwa - 23T
#293408	Hitec - 24T
#293409	Futaba - 25T

OPTION ALU SERVO HORNS - OFFSET

#293491	KO, Sanwa - 23T
#293492	Hitec - 24T
#293493	Futaba - 25T

OPTION CLAMP ALU SERVO HORNS - OFFSET

#293401	KO, Sanwa - 23T
#293402	Hitec - 24T
#293403	Futaba - 25T

OPTION CLAMP ALU SERVO HORNS - OFFSET

#293411	KO, Sanwa - 23T
#293412	Hitec - 24T
#293413	Futaba - 25T

! **IMPORTANT!** When an aluminum horn is used, the steering servo saver is not used. This increases the risk of breaking the servo in serious crashes.



902305
SH M3x5



903305
SFH M3x5

OPTION #302590
ALU DUAL SERVO SAVER SCREW M3x7 (2)

The optional screw removes excessive radial play from the steering.

OPTION #302571
X4 GRAPHITE STEERING PLATE SET

The optional graphite bridge stiffens the steering assembly and improves initial steering response. This option is mainly recommended for medium- to high-grip carpet racing.

4. STEERING



301158
SCREW 3x5.5



902305
SH M3x5

#301080
GRAPHITE UPPER DECK - 2.0mm
OPTION

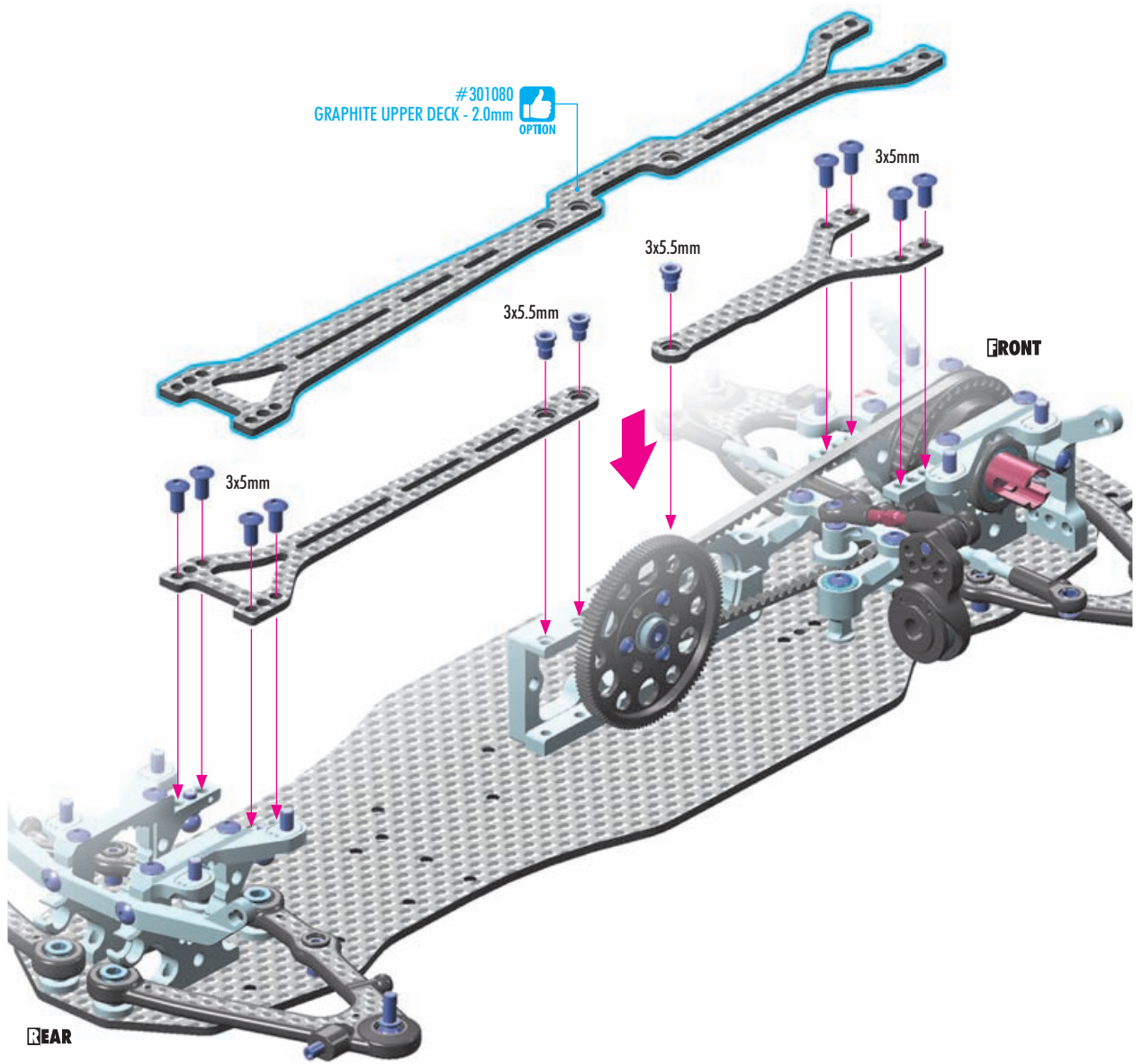

VIDEO TECH TIP



TOP DECK FLEX

TOP DECK (SPLIT) FLEX SETTINGS

The new feature of the split top deck is the flex setting adjustment. There are two different flex setting alternatives.

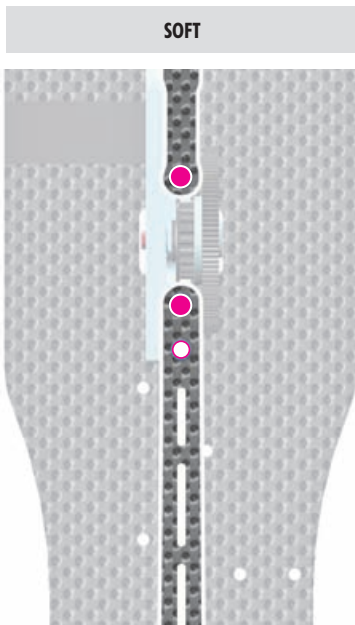

This allows maximum flex and provides maximum steering and rotation. However, the car is less stable on-power.

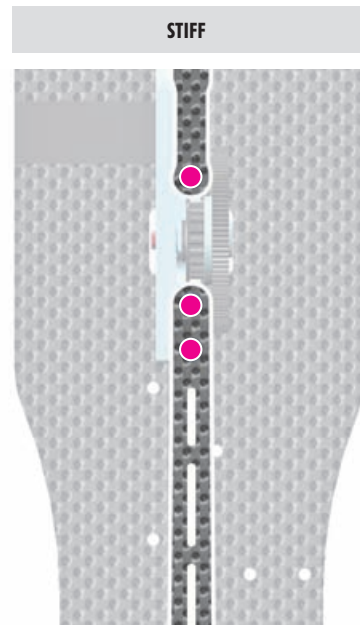

This setting gives reduced flex in the rear which improves stability and on-power traction.

5. FRONT & REAR SUSPENSION

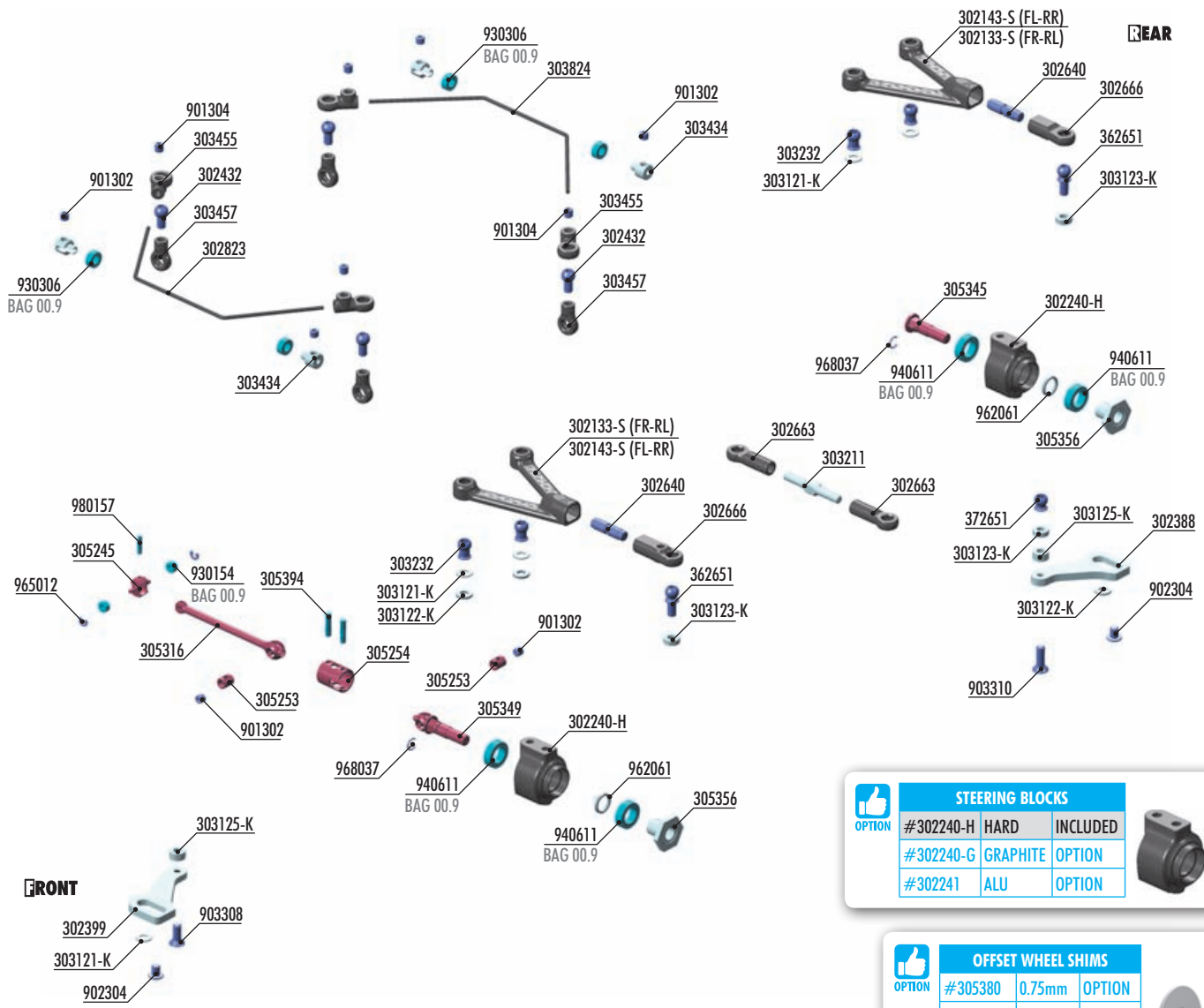

UPPER ARMS CFF™				
OPTION	#302143-S	SOFT	FL-RR	INCLUDED
	#302133-S	SOFT	FR-RL	INCLUDED
	#302143-M	MEDIUM	FL-RR	OPTION
	#302133-M	MEDIUM	FR-RL	OPTION

OPTION	#305359	ALU WHEEL HUB +0.5mm
OPTION	#305354	ALU WHEEL HUB -0.5mm

STEERING BLOCKS		
OPTION	#302240-H	HARD INCLUDED
	#302240-G	GRAPHITE OPTION
	#302241	ALU OPTION

OFFSET WHEEL SHIMS		
OPTION	#305380	0.75mm OPTION
	#305382	0.5mm OPTION
	#305381	1.0mm OPTION

OPTION	#305307	ECS BB DRIVE SHAFT 59mm - SET
--------	---------	-------------------------------



302133-S	X4 CFF™ CARBON-FIBER FUSION UPPER ARM - SOFT - FR/RL	305254	ECS (ES) DRIVE SHAFT CASE FOR 2MM PIN - HUDY SPRING STEEL™
302143-S	X4 CFF™ CARBON-FIBER FUSION UPPER ARM - SOFT - FL/RL	305306	X4 ECS BB DRIVE SHAFT 58MM - HUDY SPRING STEEL™ - SET
302240-H	X4 COMPOSITE STEERING BLOCK - HARD	305316	X4 ECS BB DRIVE SHAFT 58MM - HUDY SPRING STEEL™ (2)
302388	X4 ALU REAR ARS PLATE - SWISS 7075 T6 (L+R)	305345	X4F DRIVE AXLE - HUDY SPRING STEEL™
302399	X4F ALU FRONT STEERING PLATE - SWISS 7075 T6 (2)	305349	X4 ECS DRIVE AXLE - SPRING CLIP - HUDY SPRING STEEL™
302432	STEEL BALL END 4.9MM WITH 4MM THREAD (2)	305356	X4 ALU WHEEL HUB - SPRING CLIP - SWISS 7075 T6 (2)
302640	ADJUSTABLE CAMBER SCREW 14MM M4 L/R - HUDY SPRING STEEL™ (2)	305394	ECS DRIVE SHAFT PIN 2 x 9 WITH FLAT SPOT (2)
302663	COMPOSITE BALL JOINT 4.9MM - OPEN - V2 (8)	362651	BALL END 4.9MM WITH THREAD 8MM (2)
302666	COMPOSITE BALL JOINT 4.9MM F+R - OPEN (2+2)	372651	PIVOT BALL UNIVERSAL 4.9 MM (2)
302823	X4 ANTI-ROLL BAR - FRONT 1.3 MM	901302	HEX SCREW SB M3x2.5 (10)
303121-K	ALU SHIM 3x6x0.5MM - BLACK (10)	901304	HEX SCREW SB M3x4 (10)
303122-K	ALU SHIM 3x6x1.0MM - BLACK (10)	902304	HEX SCREW SH M3x4 - STAINLESS (10)
303123-K	ALU SHIM 3x6x2.0MM - BLACK (10)	903308	HEX SCREW SFH M3x8 (10)
303125-K	ALU SHIM 3x6x3.0MM - BLACK (10)	903310	HEX SCREW SFH M3x10 (10)
303211	ALU ADJUSTABLE TURNBUCKLE L/R 30 MM - SWISS 7075 T6 (2)	930154	BALL-BEARING 1.5x4x2 STEEL-SEALED - OIL (4)
303232	X4 UPPER ARM BALL UNIVERSAL 4.9MM - HUDY SPRING STEEL™ (2)	930306	BALL-BEARING 3x6x2.5 STEEL-SEALED - OIL (2)
303434	ALU ANTI-ROLL BAR BUSHING ø2.0mm - 6MM (2)	940611	BALL-BEARING 6x10x3 RUBBER SEALED - OIL (2)
303455	COMPOSITE ANTI-ROLL BAR BALL JOINT 4.9 MM (4)	962061	WASHER S 6x7.5x1.0 (10)
303457	BALL JOINT 4.9MM - EXTRA SHORT OPEN (4)	965012	E-CLIP 1.2 (10)
303824	X4 ANTI-ROLL BAR - REAR 1.4 MM	968037	C-CLIP 3.7 (10)
305245	ECS BB DRIVE SHAFT ADAPTER - HUDY SPRING STEEL™ (2)	980157	PIN 1.5x7.3 (10)
305253	ECS DRIVE SHAFT COUPLING FOR 2MM PIN - HUDY SPRING STEEL™		

Numbers in parentheses () refer to quantities when purchased separately.

5. FRONT & REAR SUSPENSION

901302
SB M3x2.5

305394
P 2x9

968037
C 3.7

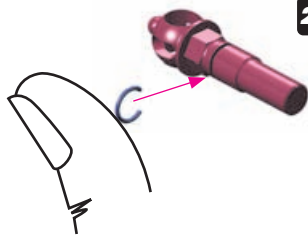

2x FRONT TRANSMISSION - ECS DRIVE SHAFT



Insert the clip into the groove on the axle. The clip should fit smoothly without extra force and should not require pliers. Make sure the clip will rotate after installation.



THREAD LOCK



Apply a small amount of thread lock and confirm it does not leak onto other driveshaft parts. After assembly, wait until the thread lock dries and check if the drive shaft and axle can move freely in all directions.

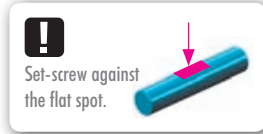

2x9mm

Make sure the pin is centered in the driveshaft after assembly.

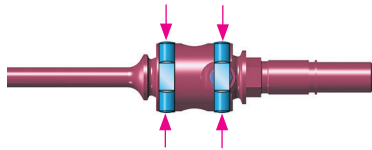

HUDY GRAPHITE GREASE (HUDY #106210)

HUDY GR

THREAD LOCK



VIDEO TECH TIP



DRIVE SHAFTS



#305307
ECS BB DRIVE SHAFT 59mm - SET



930154
BB 1.5x4x2

965012
E 1.2

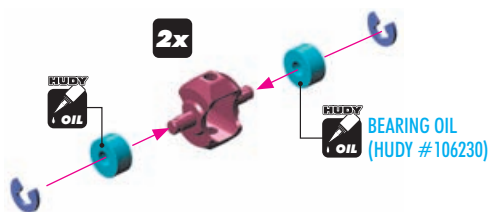

980157
P 1.5x7.3



5. FRONT & REAR SUSPENSION

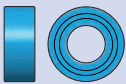

940611
BB 6x10x3



962061
S 6x7.5x1



968037
C 3.7

2x REAR TRANSMISSION

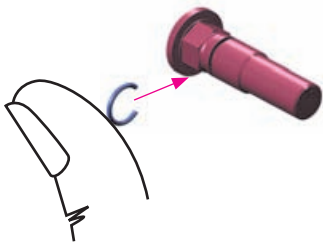

Insert the clip into the groove on the axle. The clip should fit smoothly without extra force and should not require pliers. Make sure the clip will rotate after installation.



X4F'23 wheel hubs are 0.5mm narrower than the X4F, resulting in 1mm narrower track width for improved steering and traction. To increase width, use the optional offset wheel shims or hexes.

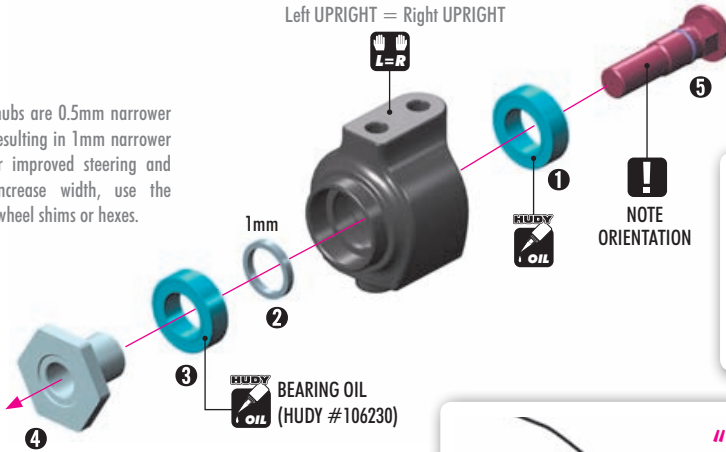

Left UPRIGHT = Right UPRIGHT



NOTE ORIENTATION

1mm

BEARING OIL (HUDY #106230)

OPTION	OFFSET WHEEL SHIMS	
#305380	0.75mm	OPTION
#305382	0.5mm	OPTION
#305381	1.0mm	OPTION

To adjust the width of the car, optional wheel shims can be quickly added or removed.



VIDEO TECH TIP



FRONT & REAR UPRIGHTS

OPTION	HUBS	
#302240-H	HARD	INCLUDED
#302240-G	GRAPHITE	OPTION
#302241	ALU	OPTION

HARD hubs are recommended for low traction to generate more grip.

Optional hubs are recommended for high traction surfaces to improve rotation and free up the car, but they will decrease traction. ALU hubs also improve durability in serious crashes.

#305359
ALU WHEEL HUB +0.5mm

The wider wheel hubs free up the car and improve cornering speed in high traction conditions.

#305354
ALU WHEEL HUB -0.5mm

For very low traction conditions, the narrower wheel hubs can generate more traction and steering but will make the car nervous and decrease cornering speed.

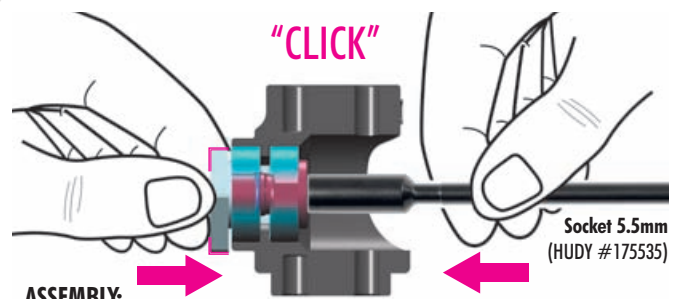

ASSEMBLY:

When installing the wheel hub on the drive axle, make sure the inside groove in the hub seats over the clip on the axle.

To confirm proper installation there should be a 'click' noise when the clip engages the inner groove in the wheel hub. There should be slight axial play once fully seated.

DISSASSEMBLY:

To remove the wheel hub from the axle, push the end of the axle back through the wheel hub to separate the wheel hub from the inner clip.

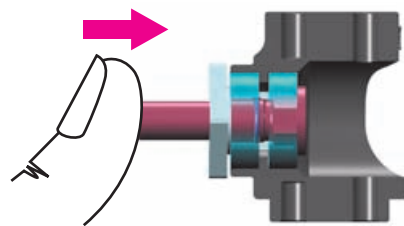

CUTAWAY VIEW

2x REAR TRANSMISSION

DO NOT OVERTIGHTEN

The thread in the rear ARS plate is very short; therefore, make sure to tighten the screw gently.

NOTE ORIENTATION



BOTTOM VIEW



902304
SH M3x4



903310
SFH M3x10

5. FRONT & REAR SUSPENSION



2x FRONT TRANSMISSION

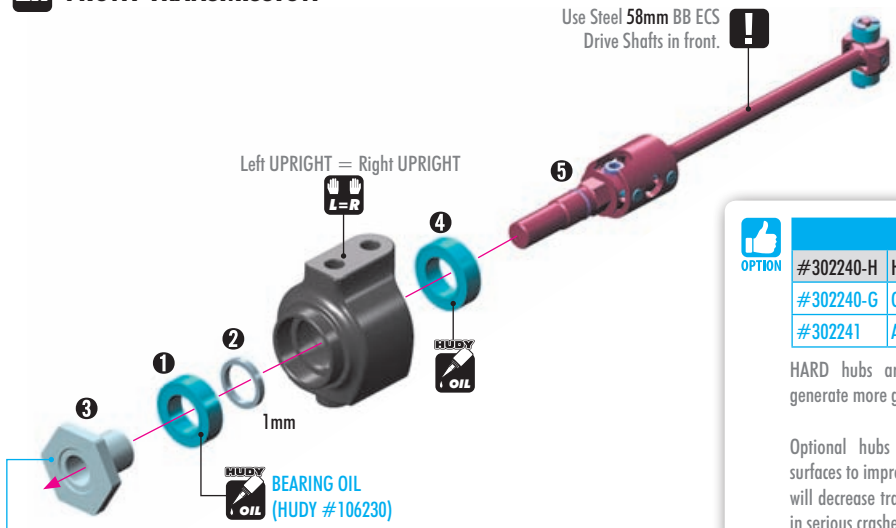

HUBS

OPTION	Part #	Material	Status
	#302240-H	HARD	INCLUDED
	#302240-G	GRAPHITE	OPTION
	#302241	ALU	OPTION

HARD hubs are recommended for low traction to generate more grip.

Optional hubs are recommended for high traction surfaces to improve rotation and free up the car, but they will decrease traction. ALU hubs also improve durability in serious crashes.

X4'23 wheel hubs are 0.5mm narrower than the X4, resulting in 1mm narrower track width for improved steering and traction. To increase width, use the optional offset wheel shims or hexes.

OFFSET WHEEL SHIMS

OPTION	Part #	Thickness	Status
	#305380	0.75mm	OPTION
	#305382	0.5mm	OPTION
	#305381	1.0mm	OPTION

To adjust the width of the car, optional wheel shims can be quickly added or removed.

#305359 ALU WHEEL HUB +0.5mm

The wider wheel hubs free up the car and improve cornering speed in high traction conditions.

#305354 ALU WHEEL HUB -0.5mm

For very low traction conditions, the narrower wheel hubs can generate more traction and steering but will make the car nervous and decrease cornering speed.

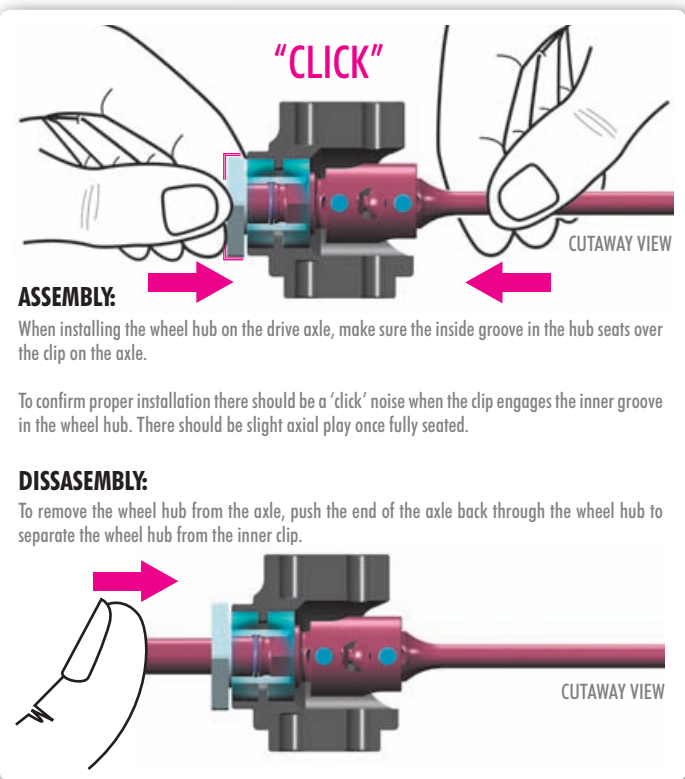

2x FRONT TRANSMISSION

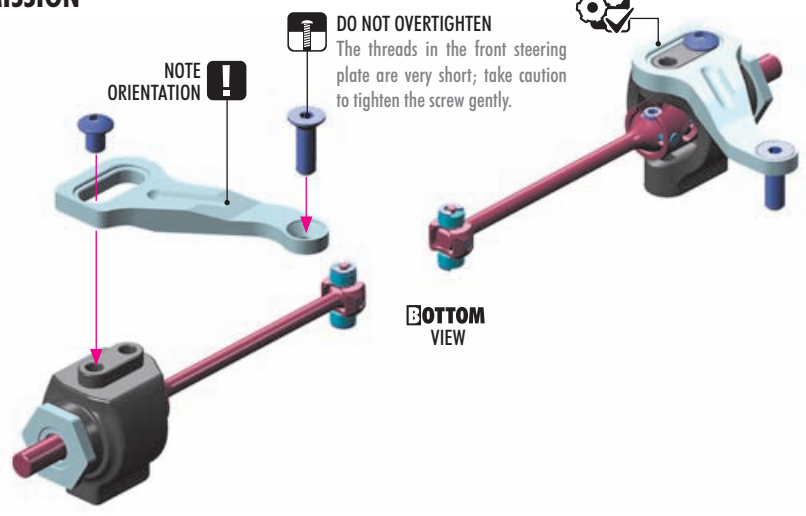

5. FRONT & REAR SUSPENSION

2x REAR

29.5mm

1 Push inside

2 Tighten

Apply Graphite Grease

2x FRONT

31mm

1 Push inside

2 Tighten

Apply Graphite Grease

VIDEO TECH TIP

CAMBER & UPPER ARMS

2x REAR

24mm

2.0 mm

! BOTTOM NOTE ORIENTATION

Shiny side

Ball joint should be aligned in the arm with the shiny side facing down.

FRONT

REAR

RIGHT

LEFT

Check arm orientation so that each arm is in the correct location with the markings facing down when installed.

2x FRONT

25.5mm

2.0 mm

! BOTTOM NOTE ORIENTATION

Shiny side

Cut out

Ball joint should be aligned in the arm with the machined clearance facing down.

FRONT

REAR

RIGHT

LEFT

Check arm orientation so that each arm is in the correct location with the markings facing down when installed.

303122-K
SHIM 3x6x1

VIDEO TECH TIP

ROLL-CENTER

2x REAR SUSPENSION

1.0mm

Raising the rear axle height will free up the rear and improve rotation and off-power steering. Mainly recommended for medium- to high-traction asphalt surfaces. Minimum shim thickness is 0.5mm; DO NOT use thinner.

5. FRONT & REAR SUSPENSION

303121-K
SHIM 3x6x0.5

2x FRONT SUSPENSION

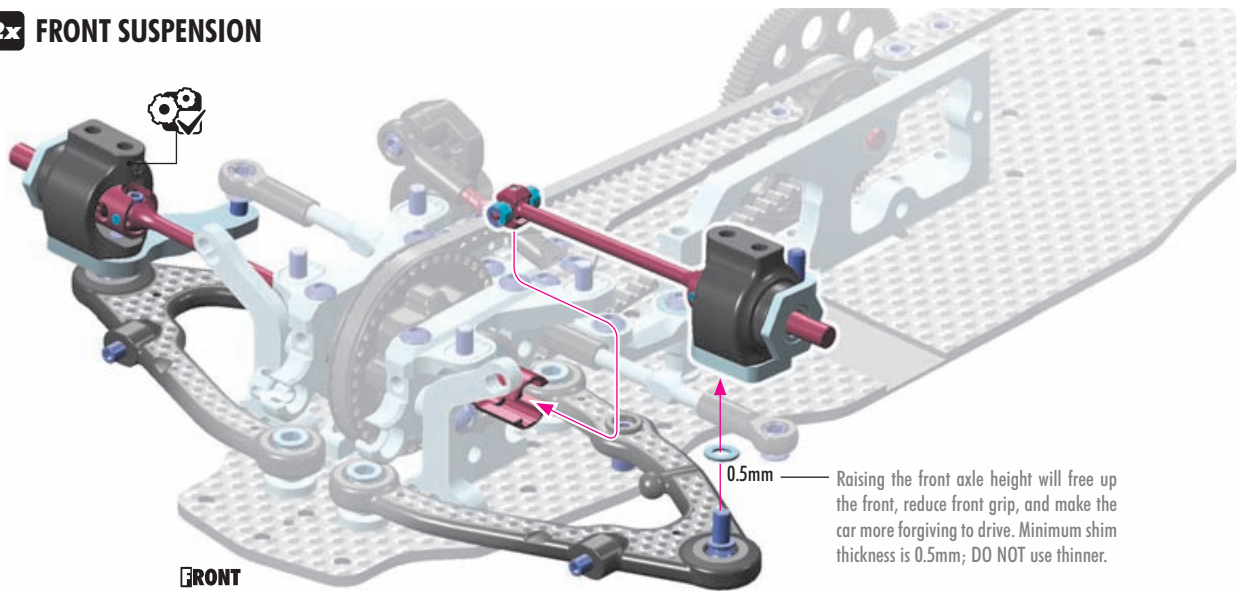

0.5mm — Raising the front axle height will free up the front, reduce front grip, and make the car more forgiving to drive. Minimum shim thickness is 0.5mm; DO NOT use thinner.

FRONT

303121-K
SHIM 3x6x0.5

303123-K
SHIM 3x6x2

2x REAR

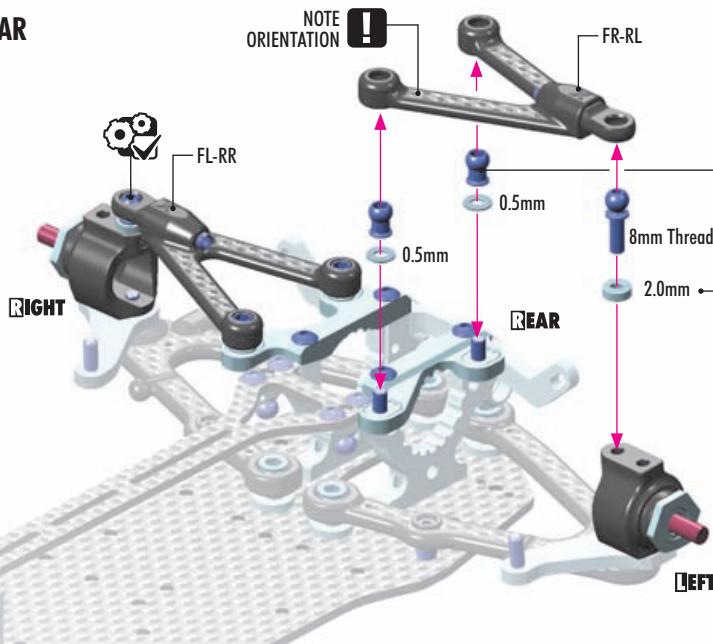

TIP Install the pivot balls with Professional Multi Tool (HUDY #183011).



Rear upper arm location affects the rear roll-center and camber gain. Raising the arm with thicker shims on the upper clamps will lower the rear roll-center and decrease camber gain. Reducing the shim height on the upper clamps has the same effect as increasing the shim height on the outside.

UPPER ARMS CFF™			
OPTION	#302143-S	SOFT	FL-RR INCLUDED
	#302133-S	SOFT	FR-RL INCLUDED
	#302143-M	MEDIUM	FL-RR OPTION
	#302133-M	MEDIUM	FR-RL OPTION

SOFT upper arms are included for most traction and steering characteristics. Optional MEDIUM upper arms improves stability and cornering speed in high grip condition. MEDIUM upper arms also improves durability of the arm in the serious crashes.



VIDEO TECH TIP



ROLL-CENTER

303121-K
SHIM 3x6x0.5

303122-K
SHIM 3x6x1

303123-K
SHIM 3x6x2

2x FRONT

TIP Install the pivot balls with Professional Multi Tool (HUDY #183011).

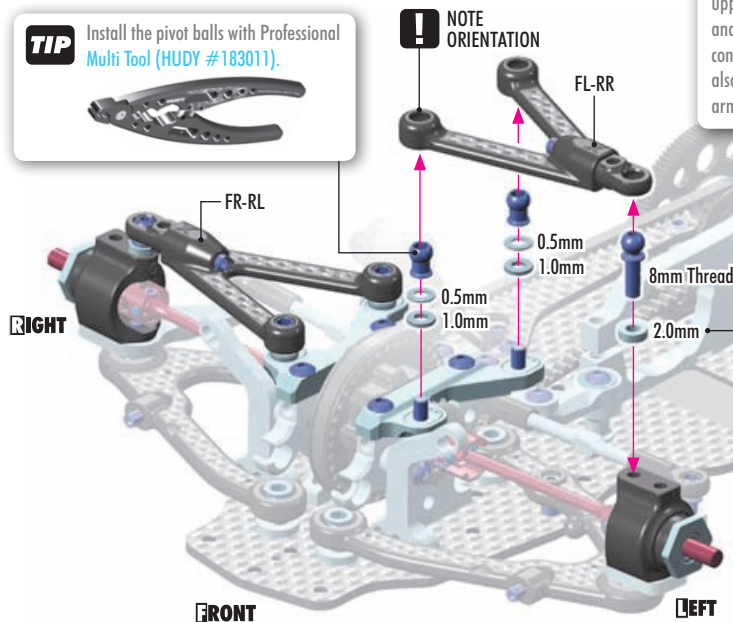

Front upper arm location affects the front roll-center and camber gain. Raising the arms with thicker shims on the upper clamps will lower the front roll-center and decrease camber gain. Reducing the shim height on the upper clamps has the same effect as increasing the shim height on the outside.

FRONT

LEFT

5. FRONT & REAR SUSPENSION

2x REAR LINKS

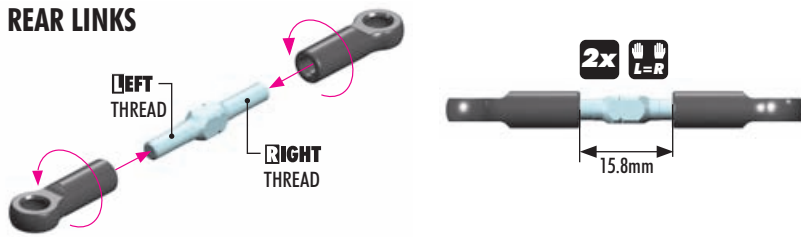

#303211-O ALU TURNBUCKLE L/R
30mm ORANGE - SWISS 7075 T6 (2)



303123-K
SHIM 3x6x2



303125-K
SHIM 3x6x3



VIDEO TECH TIP



REAR TOE-GAIN

2x REAR TRANSMISSION

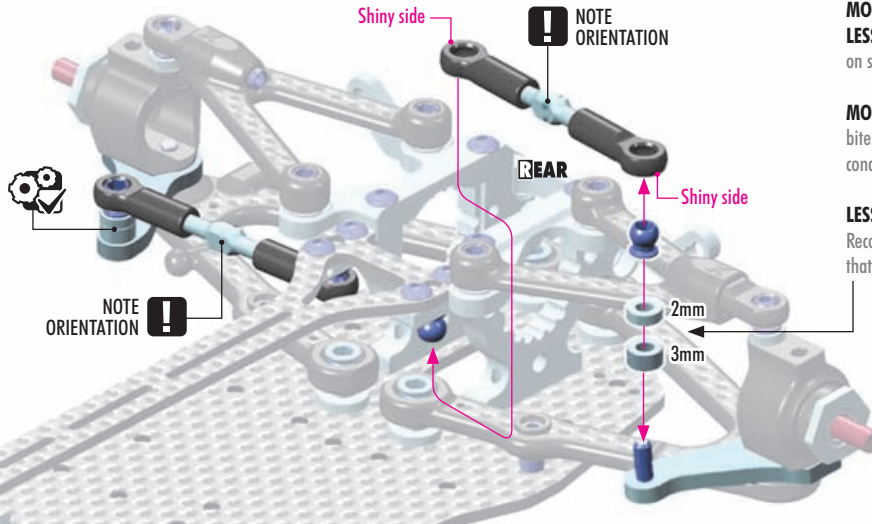

MORE SHIMS gives more toe-gain on compression.
LESS SHIMS gives less toe-gain (or even toe loss), on suspension compression.

MORE TOE-GAIN improves rear grip and side bite. Mainly recommended for low- to medium-grip conditions.

LESS TOE-GAIN reduces rear grip and side bite. Recommended for higher-grip conditions or tracks that require more steering.

TIP Install the pivot balls with Professional Multi Tool (HUDY #183011).



303125-K
SHIM 3x6x3

VIDEO TECH TIP



STEERING SYSTEM

2x FRONT TRANSMISSION

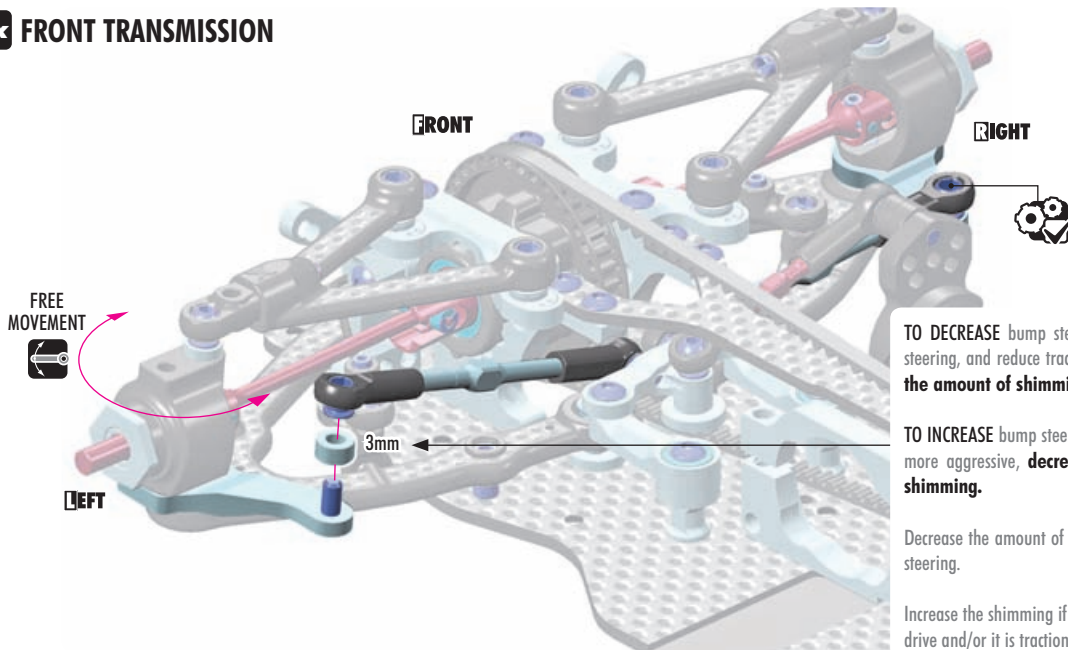

TO DECREASE bump steer, smoothen out the steering, and reduce traction rolling: **increase the amount of shimming.**

TO INCREASE bump steer, to make the steering more aggressive, **decrease the amount of shimming.**

Decrease the amount of shimming to get more steering.

Increase the shimming if the car is difficult to drive and/or it is traction rolling.



930306
BB 3x6x2.5

VIDEO TECH TIP



ANTI-ROLL BARS

2x FRONT & REAR ANTI-ROLL BARS



OPTION	REAR ANTI-ROLL BARS
#303821	1.1mm 1 dot OPTION
#303822	1.2mm 2 dots OPTION
#303823	1.3mm 3 dots OPTION
#303824	1.4mm 4 dots INCLUDED
#303826	1.6mm 6 dots OPTION
#303828	1.8mm 8 dots OPTION

OPTION	FRONT ANTI-ROLL BARS
#302821	1.1mm 1 dot OPTION
#302822	1.2mm 2 dots OPTION
#302823	1.3mm 3 dots INCLUDED
#302824	1.4mm 4 dots OPTION
#302825	1.5mm 5 dots OPTION

BEARING OIL (HUDY #106230)



5. FRONT & REAR SUSPENSION

4x

TIP Install the pivot balls with Professional Multi Tool (HUDY #183011).

4mm Thread

2.0 mm

17mm

2x REAR TRANSMISSION

REAR

- 901302
SB M3x2.5
- 901304
SB M3x4

REAR TRANSMISSION

DETAIL

Set the bar into the center, remove the play in the bushings, and tighten the set-screws fully.

SOFTER rear anti-roll bar:
Generates more side traction. Mainly recommended for low-grip asphalt tracks.

STIFFER rear anti-roll bar:
Helps the car stay flatter and makes the car easier to drive in the chicanes. Improves cornering speed in long sweepers.

4 Dots

VIDEO TECH TIP

ANTI-ROLL BARS

TIP When the bars are set, verify that both sides move at the same time. If they do, the bars are set up correctly. If not, make sure that both downstops are the same and that the bar wire is flat.

If both sides still **DO NOT** move at the same time, adjust the length of the bar holders.

5. FRONT & REAR SUSPENSION

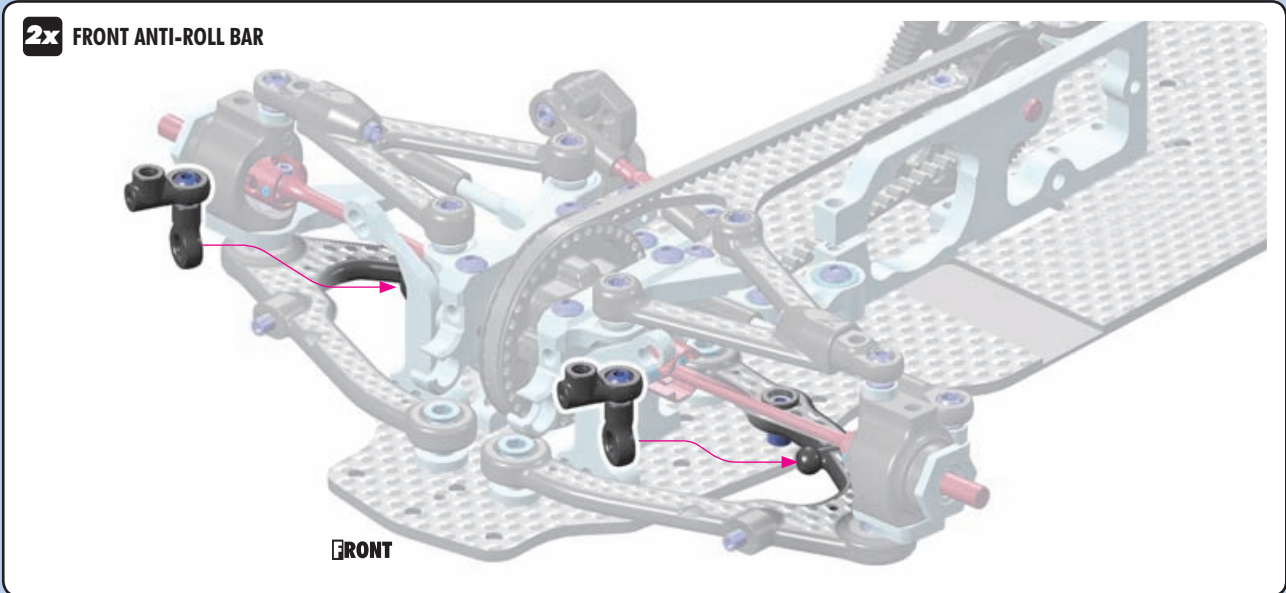

- 901302
SB M3x2.5
- 901304
SB M3x4

! FRONT ANTI-ROLL BAR

DETAIL **CENTER** **TOP**

FRONT

Set the bar into the center, remove the play in the bushings, and tighten the set-screws fully.

④ 3x4mm

④ 3x2.5mm

④ 3x2.5mm

④ 3x4mm

① 3 Dots

FRONT

SOFTER front anti-roll bar:
Allows the front to roll more which gives more front grip and improves on-power steering.

STIFFER front anti-roll bar:
Makes the car initially more responsive, and helps the car stay flatter on fast direction changes. Reduces steering from mid-corner to corner exit. Mainly recommended for high-grip carpet.

When the bars are set, verify that both sides move at the same time. If they do, the bars are set up correctly. If not, make sure that both downstops are the same and that the bar wire is flat.

If both sides still **DO NOT** move at the same time, adjust the length of the bar holders.

VIDEO TECH TIP

ANTI-ROLL BARS

6. SHOCK ABSORBERS

4x

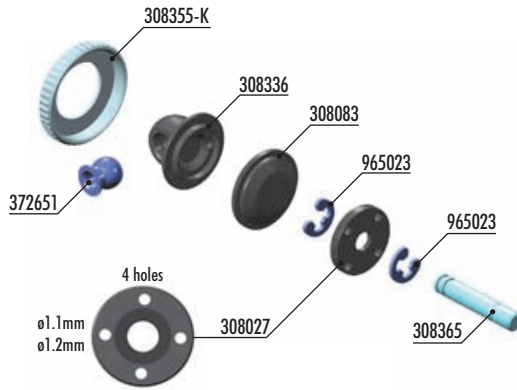

#104002
 HUDY AIR VAC – VACUUM PUMP - ON-ROAD

XRAY SPRINGS

OPTION	Part #	C	Quantity
	#308164	C = 2.4-2.7	OPTION
	#308165	C = 2.5-2.8	INCLUDED
	#308166	C = 2.6-2.9	OPTION
	#308175	C = 2.5	OPTION
	#308176	C = 2.6	INCLUDED
	#308177	C = 2.7	OPTION
	#308178	C = 2.8	OPTION
	#308179	C = 2.9	OPTION

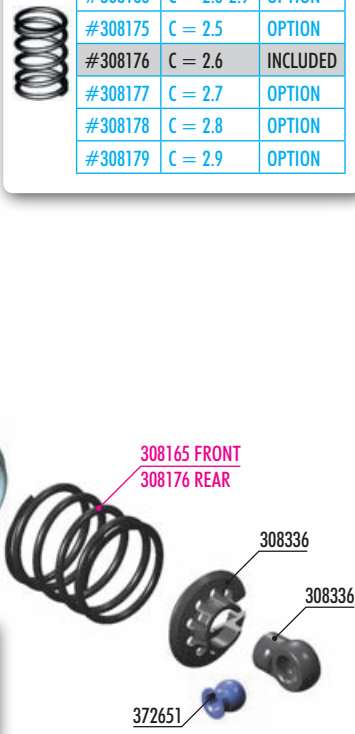

#308308-K
 ULP ALU SHOCK ABSORBER SET - BLACK (2)

! Must be used with X4 shock towers:
 #301970 and #302970

#308029
 XLP/ULP ALU PROGRESSIVE SHOCK SYSTEM - SET (2)

The progressive shock inserts improve steering characteristics. The ULP PSS set fits the stock XLP shock bodies included in the kit. Must be used with:
 #308026 - XLP Progressive Pistons.

#308033-K
 ALU XLP SHOCK SPRING RETAINING COLLAR - BLACK (4)

#308026
 XLP COMPOSITE 2-HOLE ø0.8mm PROGRESSIVE PISTON (4)

VIDEO TECH TIP SHOCKS & SPRINGS

BAG
06

- | | | | |
|----------|---|--------|--|
| 308027 | XLP COMPOSITE 4-HOLE 1.1-1.2MM PISTON (2+2) | 308365 | XLP HARDENED SHOCK SHAFT (2) |
| 308045-K | XLP ALU SHOCK ADJUSTABLE NUT - BLACK (2) | 372651 | PIVOT BALL UNIVERSAL 4.9 MM - HUDY SPRING STEEL™ (2) |
| 308083 | XLP SHOCK ABSORBER MEMBRANE (4) | | |
| 308092 | SHOCK FOAM INSERTS (4) (OPTION) | 965023 | E-CLIP 2.3 (10) |
| 308309-K | XLP ALU SHOCK ABSORBER-SET - BLACK (2) | 970131 | O-RING 13 x 1.0 (10) |
| 308325 | XLP ALU SHOCK BODY (2) | 972030 | SILICONE O-RING 3 x 2 (10) |
| 308328-K | XLP ALU CAP FOR SHOCK BODY - BLACK (2) | | |
| 308336 | XLP COMPOSITE SHOCK PARTS WITH 2 HOLES | 308165 | XLP SPRING-SET PROGRESSIVE C=2.5-2.8 (2) |
| 308355-K | XLP ALU SHOCK CAP-NUT - BLACK (2) | 308176 | XLP SPRING-SET C=2.6 (2) |

Numbers in parentheses () refer to quantities when purchased separately.

965023
 E 2.3

4x

NOTE ORIENTATION

4 holes (INITIAL SETTING)

ø1.1mm (INITIAL SETTING)

ø1.2mm

#308026
 XLP COMPOSITE 2-HOLE ø0.8mm PROGRESSIVE PISTON (4)

! These pistons must be used with optional:
 #308029 XLP/ULP PROGRESSIVE SHOCK INSERTS

6. SHOCK ABSORBERS

OIL
972030
0 3x2

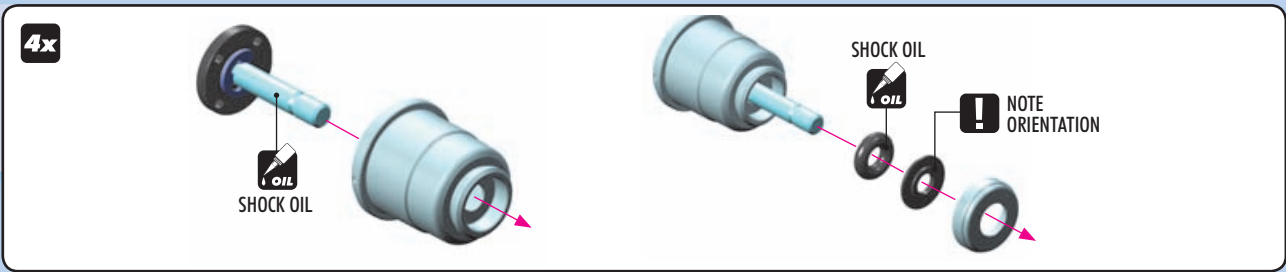

OIL
970131
0 13x1.0

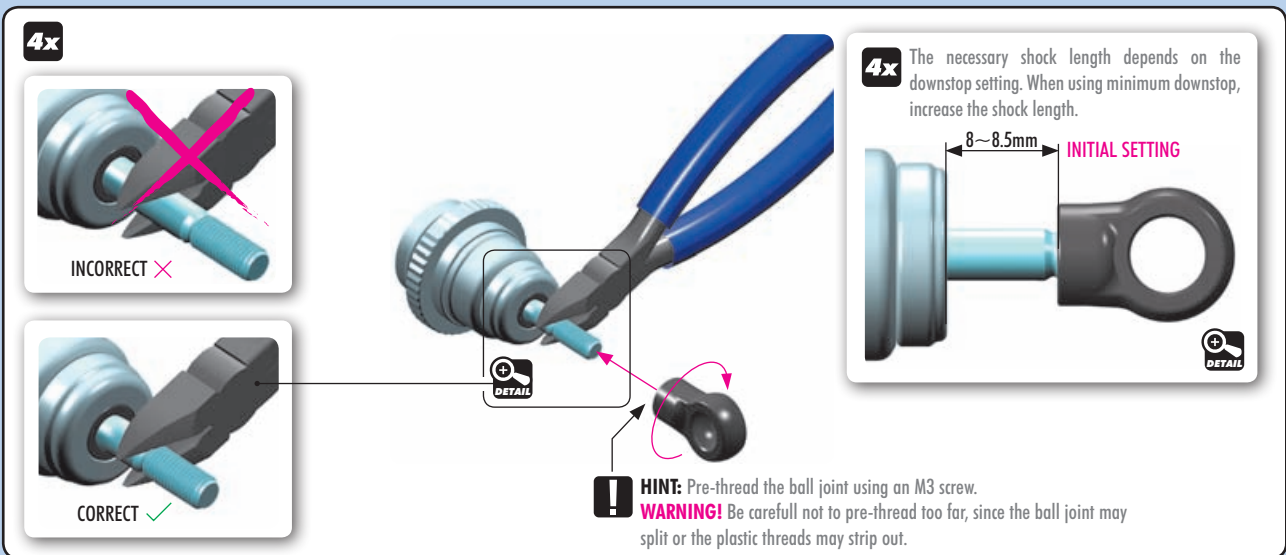
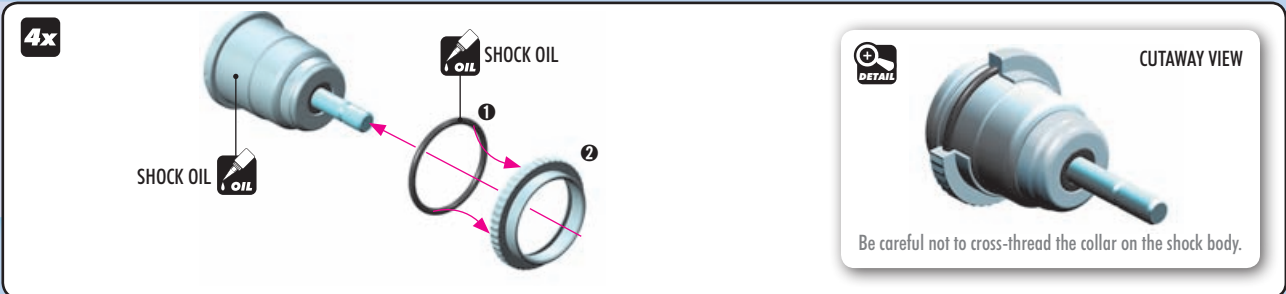

VIDEO TECH TIP

HUDY AIR-VAC SHOCK BUILD

- OIL 350cSt**
- SHOCK FILLING**
- 4x**
- 1 Fully extend the piston rod so the piston is at the bottom of the shock body.
 - 2 Hold the shock upright and slightly overfill the shock body with shock oil.
 - 3 Let the oil settle and allow air bubbles to rise to the top. Slowly move the piston up and down to allow oil into all cavities within the shock body.
 - 4 Extend the piston rod most of the way out of the shock body. Let the shock rest for 5 minutes to allow the air bubbles to escape.
 - 5 Add shock oil as necessary.

SHOCK OILS (50ml)

OPTION	SHOCK OILS (50ml)	OPTION	SHOCK OILS (50ml)	OPTION
#106325	250cSt	OPTION	#106352	525cSt
#106330	300cSt	OPTION	#106355	550cSt
#106335	350cSt	INCLUDED	#106357	575cSt
#106337	375cSt	OPTION	#106360	600cSt
#106340	400cSt	OPTION	#106362	625cSt
#106342	425cSt	OPTION	#106365	650cSt
#106345	450cSt	OPTION	#106367	675cSt
#106347	475cSt	OPTION	#106370	700cSt
#106350	500cSt	OPTION	#106375	750cSt
			#106380	800cSt

TIP **#104002**
OPTION HUDY AIR VAC – VACUUM PUMP

To make sure that all the air is removed from the shock oil, we recommend using the HUDY Air Vac.

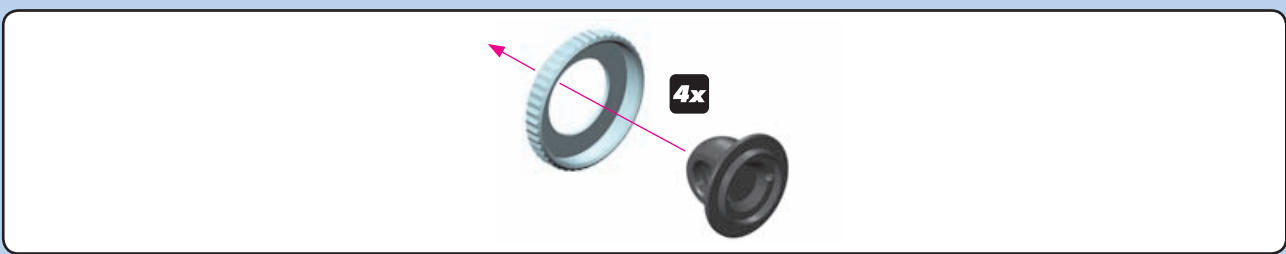

6. SHOCK ABSORBERS

4x **1 REBOUND ADJUSTMENT**

For most conditions, 0-25% rebound is recommended. This is the most forgiving and best to absorb bumps. Cornering speed is generally the best with this setting.

0-25% Rebound (INITIAL SETTING)

50% Rebound

100% Rebound

For certain low grip conditions, adding additional rebound may improve initial reaction and side bite. Direction change will be faster and may feel like the car is creating more traction. Note that higher rebound settings will make the car less stable over bumps and may increase the tendency to traction roll.

4x

2 Insert shock membrane.

3 Gently push shock membrane to remove excess oil. But DO NOT push the membrane too hard otherwise it can fall inside the shock body.

4 Tighten shock cap.

VIDEO TECH TIP

SHOCKS & SPRINGS

4x **SHOCK LENGTH ADJUSTMENT:**

! It is VERY IMPORTANT that all shocks are equal length.

Fully extend the shock absorber and measure the end-to-end length; we recommend using digital calipers to give an accurate measurement. If a shock absorber is shorter or longer than others, adjust the shock length by tightening or loosening the ball joint on the shock rod.

Laser engraved springs.

FRONT C = 2.5-2.8

REAR C = 2.6

TIP Install the pivot balls with Professional Multi Tool (HUDY #183011).

#308033-K
ALU XLP SHOCK SPRING RETAINING COLLAR - BLACK (4)



7. FRONT & REAR ASSEMBLY

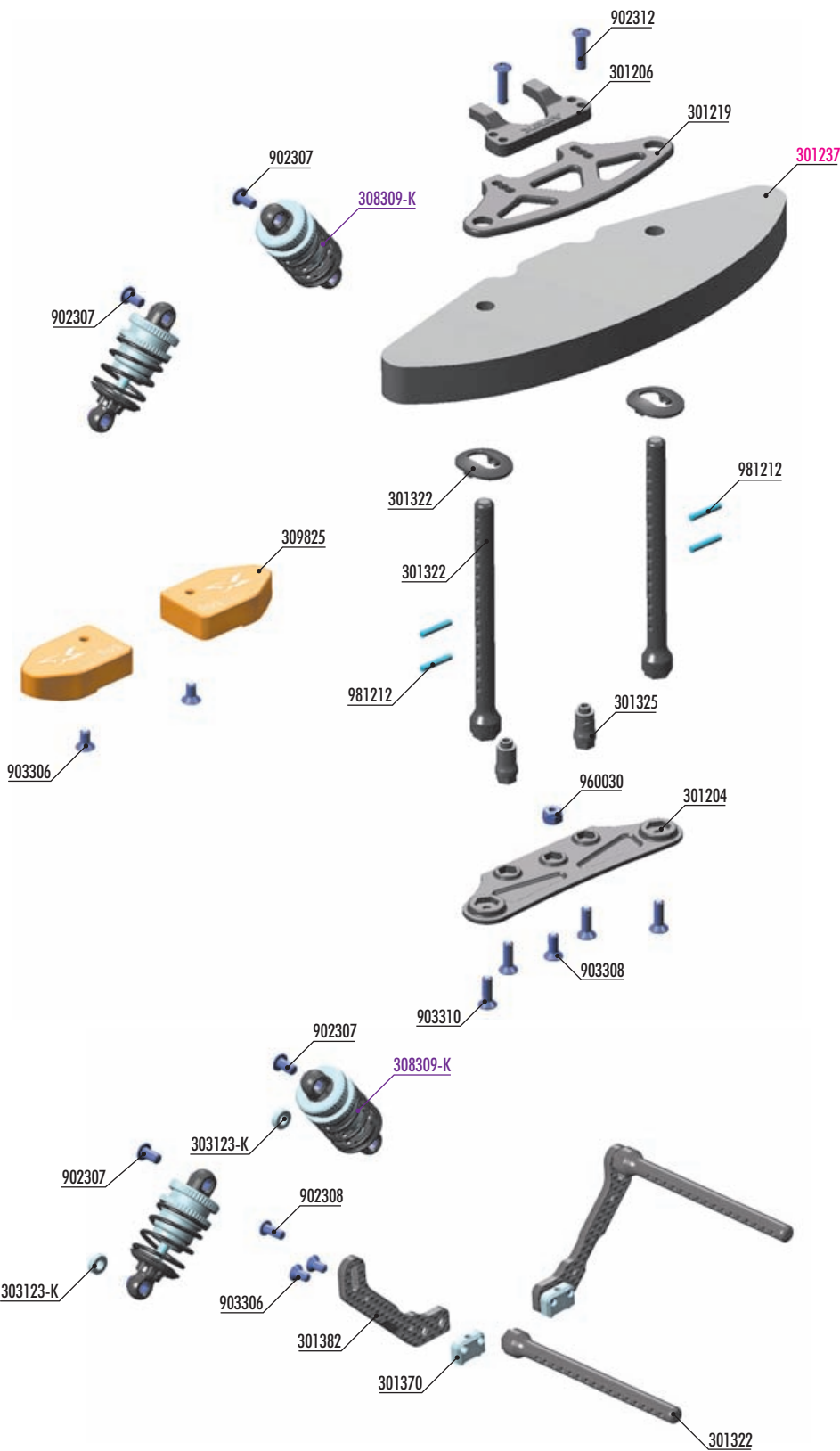

FRONT BODY MOUNT SET

#301322	0mm	INCLUDED
#301323	+1mm	OPTION
#301324	+2mm	OPTION

FRONT ECC. BODY MOUNT SET

#301326	0mm	OPTION
#301327	+1mm	OPTION
#301328	+2mm	OPTION

#301351-0
ALU ADJUSTABLE BODY POST STOP (2)

#301232
FOAM BUMPER FOR ADJ. BODY MOUNTS - HARD

#301210
GRAPHITE UPPER HOLDER - 2.5mm
(Alu shim 4x6x2mm - INCLUDED)

#309824
X4F BUMPER WEIGHT FRONT 100g

BAG

07

- 301204 COMPOSITE BUMPER
- 301206 X4 COMPOSITE BUMPER UPPER HOLDER BRACE
- 301219 COMPOSITE UPPER HOLDER FOR BUMPER
- 301322 FRONT BODY MOUNT SET
- 301325 COMPOSITE BRACE FOR BUMPER - LOW (2)
- 301370 X4 ALU PLATE FOR REAR GRAPHITE BODY POST HOLDER
- 301382 GRAPHITE BODY POST HOLDER (L+R)
- 303123-K ALU SHIM 3x6x2.0MM - BLACK (10)
- 309825 X4F BALANCING WEIGHT FRONT LEFT & RIGHT (50+50g)

- 902307 HEX SCREW SH M3x6 SMALL HEAD (10)
- 902308 HEX SCREW SH M3x8 (10)

- 902312 HEX SCREW SH M3x12 (10)
- 903306 HEX SCREW SFH M3x6 (10)
- 903308 HEX SCREW SFH M3x8 (10)
- 903310 HEX SCREW SFH M3x10 (10)
- 960030 NUT M3 (10)
- 981212 PIN 2x12 (10)

- 301237 X4F FOAM BUMPER FOR 100g WEIGHT - HARD
- 308309-K XLP ALU SHOCK ABSORBER-SET - BLACK (2)

Numbers in parentheses () refer to quantities when purchased separately.

7. FRONT & REAR ASSEMBLY

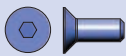

903308
SFH M3x8



903310
SFH M3x10



960030
N M3

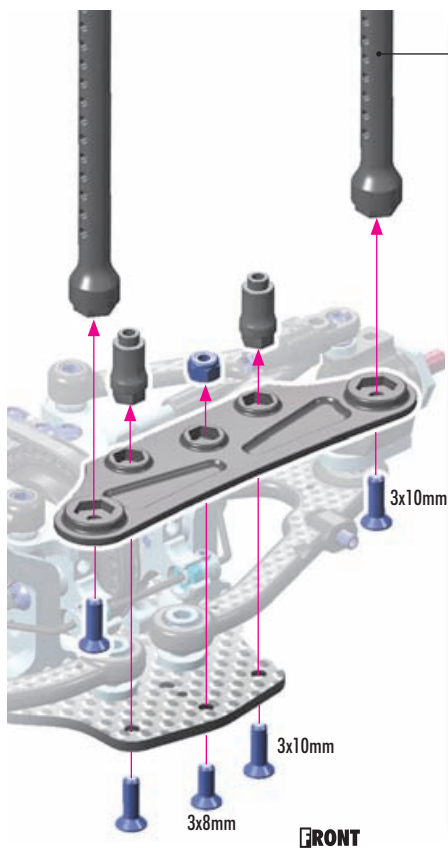

FRONT BODY POST ORIENTATION

This new, innovative feature allows the adjustment of body position for all kind of surfaces, traction conditions, touring classes, using only one body. There are THREE different body positions possible; rearward, center, and forward. Depending on conditions, the body post positions can be easily changed which allows the body to be moved.

- The body in the **REARWARD POSITION** makes the car super stable and very easy to drive. It makes the car easier to drive in chicanes and more predictable in high-traction conditions.
- The body in the **CENTER POSITION** makes the car more aggressive and steer faster, but is a slightly more difficult to drive in low-grip conditions.
- The body in the **FORWARD POSITION** is the most aggressive. It makes the car steer a lot, but is more difficult to drive when the traction is high or when the track has a lot of chicanes.

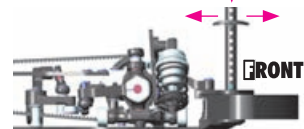
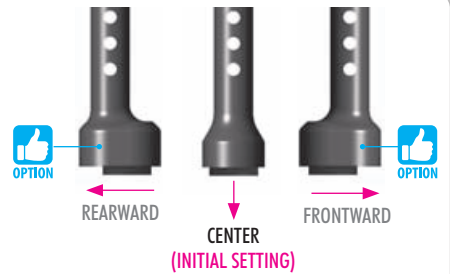

! It is important to use the same body setting (rearward and center) on both front and rear body posts at the same time.



FRONT BODY MOUNT SET

#301322	0mm	INCLUDED
#301323	+1mm	OPTION
#301324	+2mm	OPTION



FRONT ECC. BODY MOUNT SET

#301326	0mm	OPTION
#301327	+1mm	OPTION
#301328	+2mm	OPTION



902312
SH M3x12

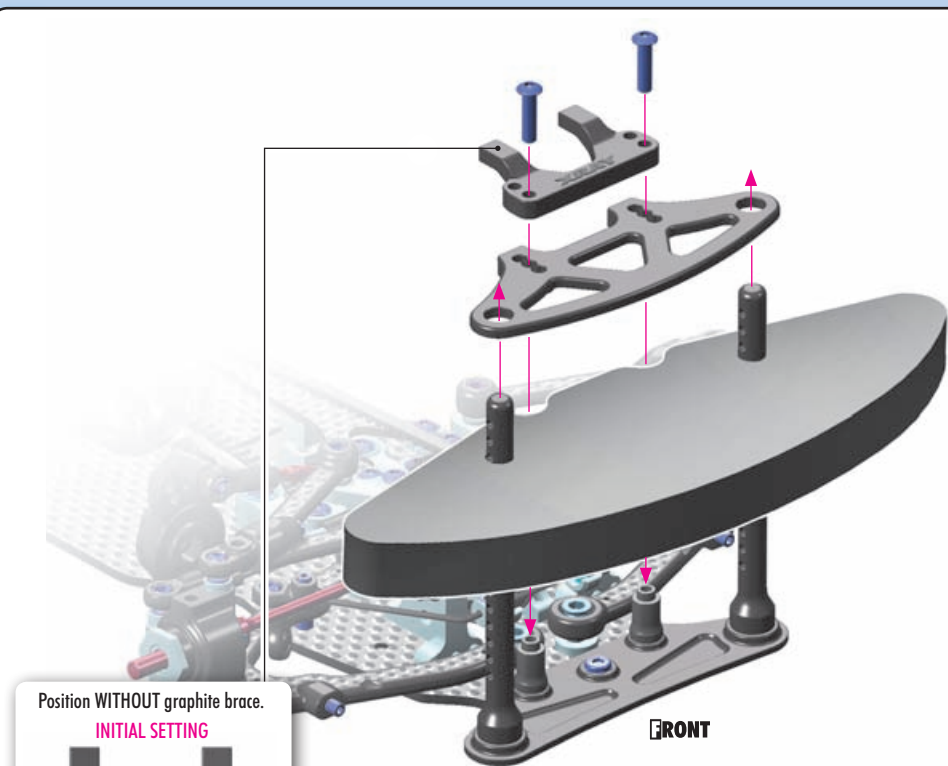

Position WITHOUT graphite brace.

INITIAL SETTING



Position WITH graphite brace.

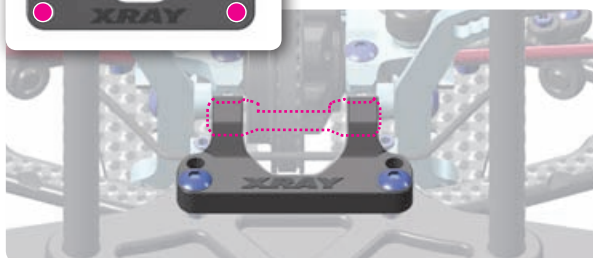

7. FRONT & REAR ASSEMBLY



903306
SFH M3x6

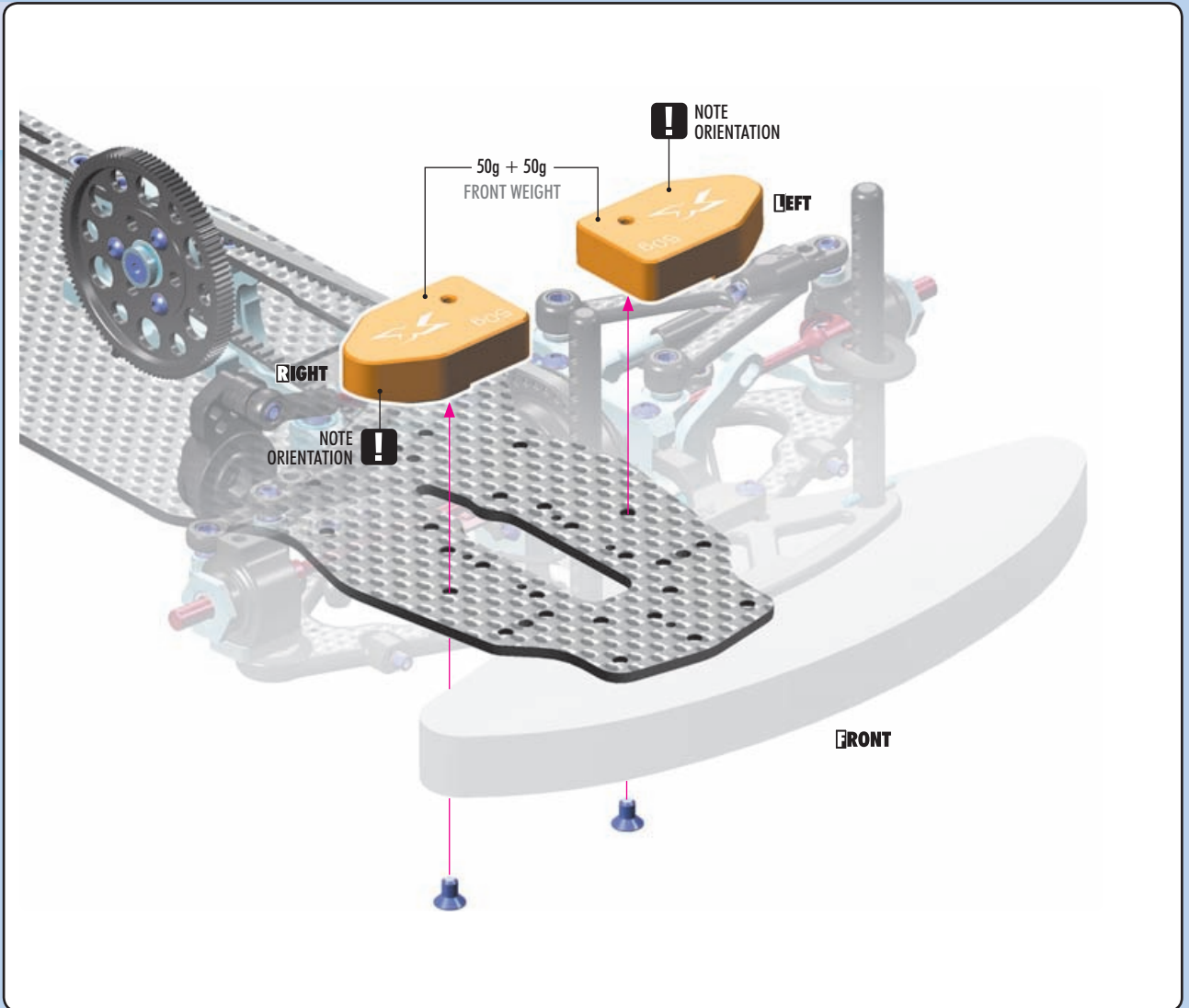

For very low traction conditions, we recommend the #309824 X4F bumper weight to improve front traction for the car.

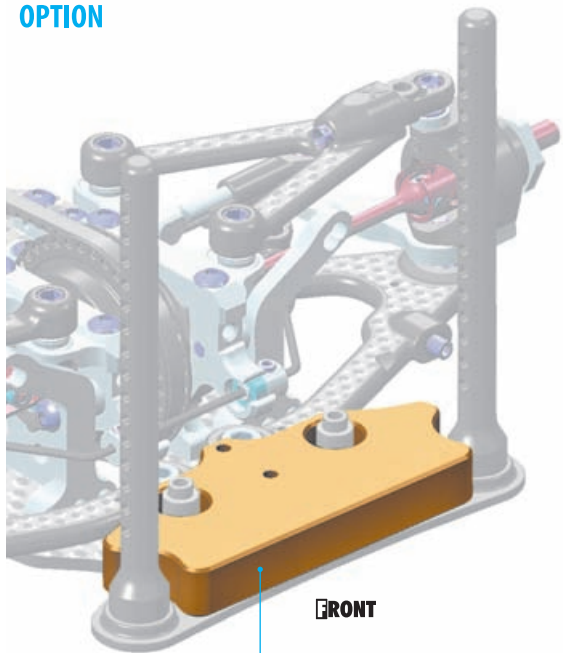

#309824
X4F BUMPER WEIGHT FRONT 100g
OPTION



#301210
GRAPHITE UPPER HOLDER FOR BUMPER 2.5mm
(Alu shim 4x6x2mm - INCLUDED)

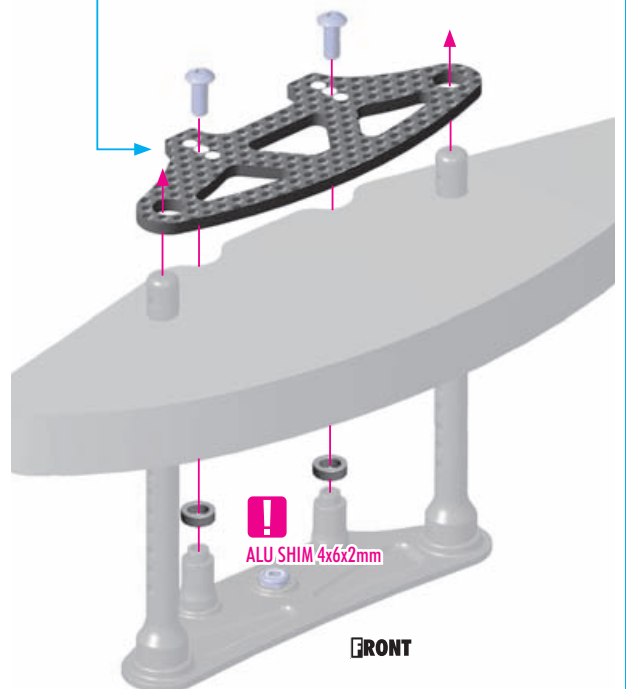

!
ALU SHIM 4x6x2mm

7. FRONT & REAR ASSEMBLY

981212
P 2x12

2x
L=R

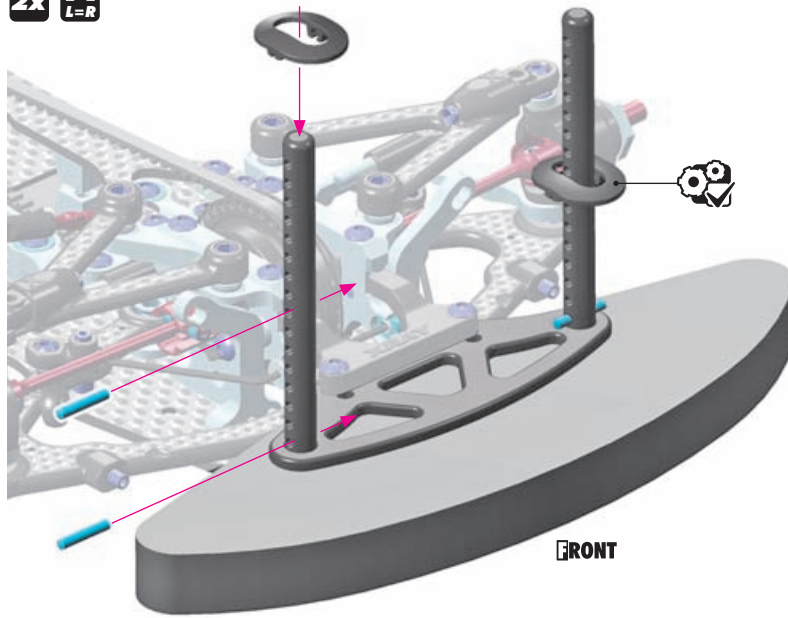

#301351-0
ALU ADJUSTABLE BODY POST STOP (2)
OPTION



Very handy, easily externally adjustable body post made from Swiss 7075 T6 aluminum. Allows for adjustment of body height by 3mm without needing to change the position on the body post.



VIDEO TECH TIP



FRONT BODY UPSTOP SYSTEM

902307
SH M3x6
SMALLER HEAD



VIDEO TECH TIP



SHOCKS & SPRINGS

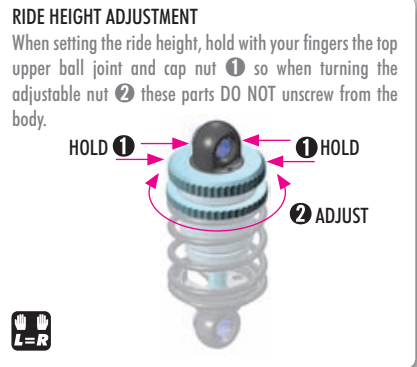
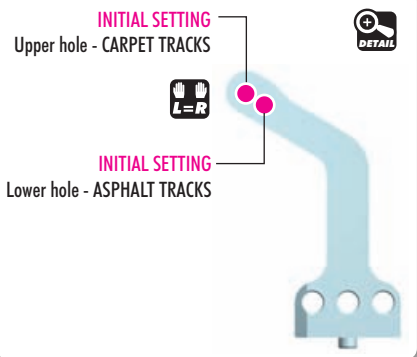
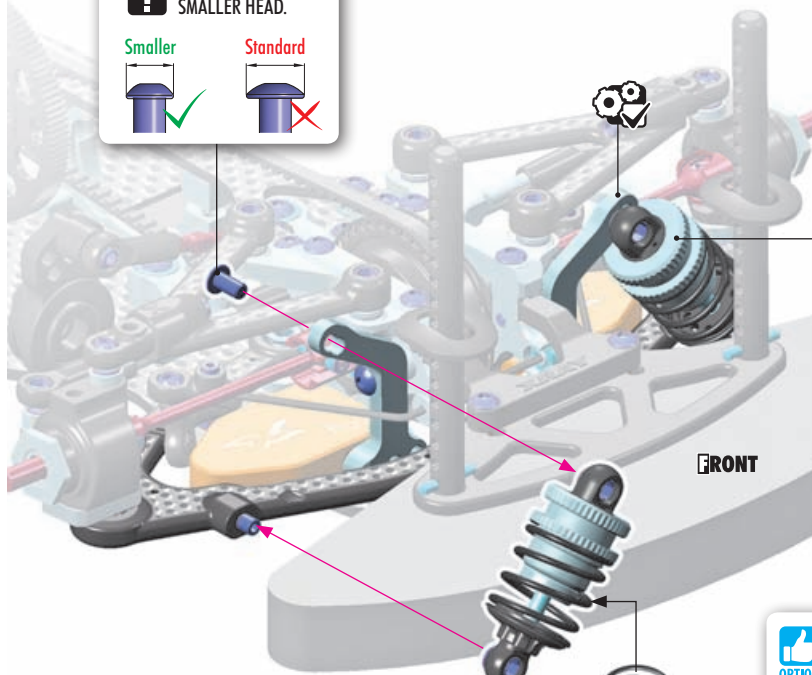
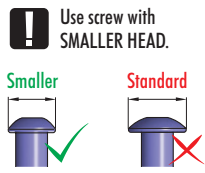

FRONT SHOCK SPRING
Laser engraved
C=2.5-2.8

#308029
XLP/ULP ALU PROGRESSIVE SHOCK SYSTEM - SET (2)
OPTION

The progressive shock inserts improve steering characteristics. The ULP PSS set fits the stock XLP shock bodies included in the kit. Must be used with #308026 - XLP Progressive Pistons.



#308026
XLP COMPOSITE 2-HOLE ø0.8mm PROGRESSIVE PISTON (4)
OPTION



7. FRONT & REAR ASSEMBLY

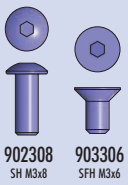

2x REAR HORIZONTAL BODY MOUNTING

(INITIAL SETTING)

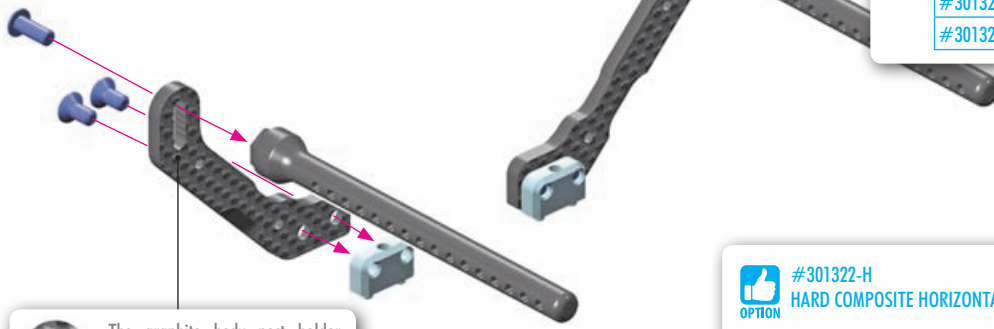

BODY MOUNT SET			
#301322	0mm	INCLUDED	
#301323	+1mm	OPTION	
#301324	+2mm	OPTION	



VIDEO TECH TIP



REAR BODY POST MOUNTING



The graphite body post holder has 5 POSITIONS, spaced 1.1mm between each, for precise and easy adjustment.



#301322-H HARD COMPOSITE HORIZONTAL REAR BODY MOUNT POST - SET

Optional HARD posts eliminates the flex of the horizontal mounting. Use these posts only for horizontal body mounting.

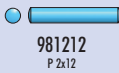

#301351-0 ALU ADJUSTABLE BODY POST STOP (2)



Very handy, easily externally adjustable body post made from Swiss 7075 T6 aluminum. Allows for adjustment of body height by 3mm without needing to change the position on the body post.

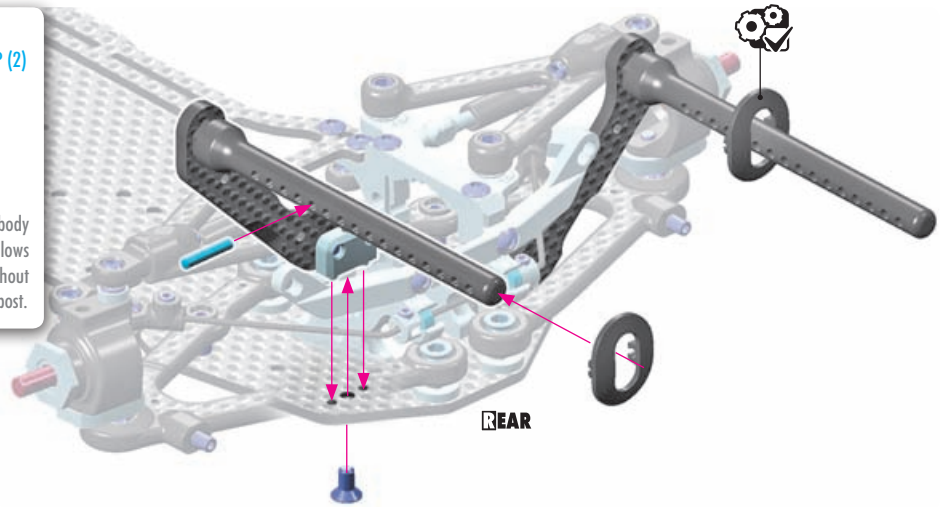

VIDEO TECH TIP



SHOCK SHIMMING TUTORIAL

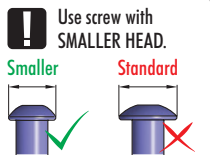

Use screw with SMALLER HEAD.

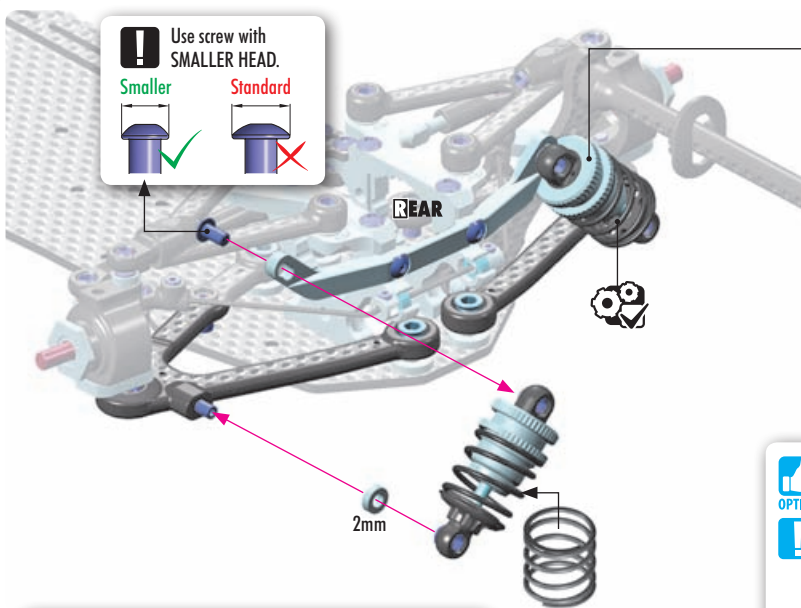

RIDE HEIGHT ADJUSTMENT

When setting the ride height, hold with your fingers the top upper ball joint and cap nut ① so when turning the adjustable nut ② these parts DO NOT unscrew from the body.

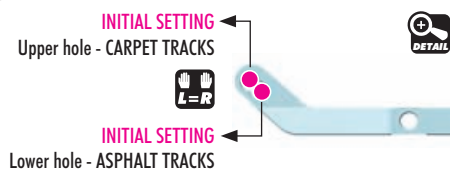

REAR SHOCK SPRING C=2.6



#308029 XLP/ULP ALU PROGRESSIVE SHOCK SYSTEM - SET (2)



The progressive shock inserts improve steering characteristics. The ULP PSS set fits the stock XLP shock bodies included in the kit. Must be used with #308026 - XLP Progressive Pistons.



#308026 XLP COMPOSITE 2-HOLE ø0.8mm PROGRESSIVE PISTON (4)



7. FINAL ASSEMBLY



902306
SH M3x6



903306
SFH M3x6



VIDEO TECH TIP



STEERING SYSTEM



903306
SFH M3x6

7. FINAL ASSEMBLY



902310
SH M3x10

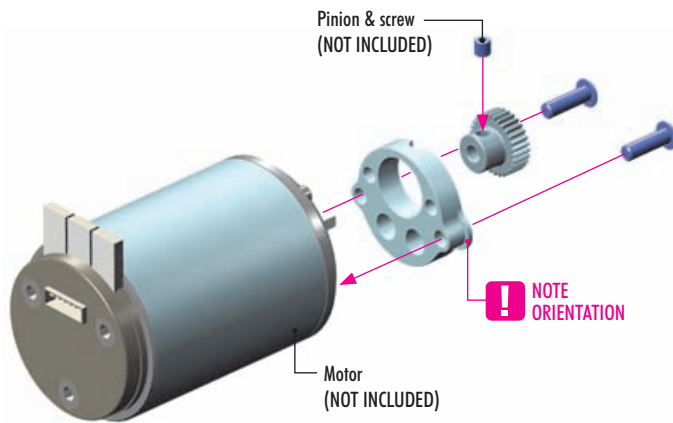

ALU PINION GEARS (OPTION)

#305912 12T / 48P	#305968 18T / 64P
#305913 13T / 48P	#305969 19T / 64P
#305914 14T / 48P	#305970 20T / 64P
#305915 15T / 48P	#305971 21T / 64P
#305916 16T / 48P	#305972 22T / 64P
#294017 17T / 48P	#305973 23T / 64P
#305918 18T / 48P	#305974 24T / 64P
#305919 19T / 48P	#305975 25T / 64P
#294020 20T / 48P	#294126 26T / 64P
#294021 21T / 48P	#294127 27T / 64P
#294022 22T / 48P	#294128 28T / 64P
#294023 23T / 48P	#294129 29T / 64P
#305924 24T / 48P	#294130 30T / 64P
#305925 25T / 48P	#294131 31T / 64P
#305926 26T / 48P	#294132 32T / 64P
#305927 27T / 48P	#294133 33T / 64P
#305928 28T / 48P	#305984 34T / 64P
#305929 29T / 48P	#305985 35T / 64P
#294030 30T / 48P	#294136 36T / 64P
#305931 31T / 48P	#294137 37T / 64P
#305932 32T / 48P	#294138 38T / 64P
#294033 33T / 48P	#294139 39T / 64P
#305934 34T / 48P	#294140 40T / 64P
#294035 35T / 48P	#294141 41T / 64P
	#294142 42T / 64P
	#294143 43T / 64P
	#294144 44T / 64P
	#294145 45T / 64P
	#294146 46T / 64P
	#294147 47T / 64P
	#294148 48T / 64P
	#294149 49T / 64P
	#294150 50T / 64P
	#294152 52T / 64P
	#294154 54T / 64P
	#294156 56T / 64P
	#294158 58T / 64P
	#294160 60T / 64P



902312
SH M3x12

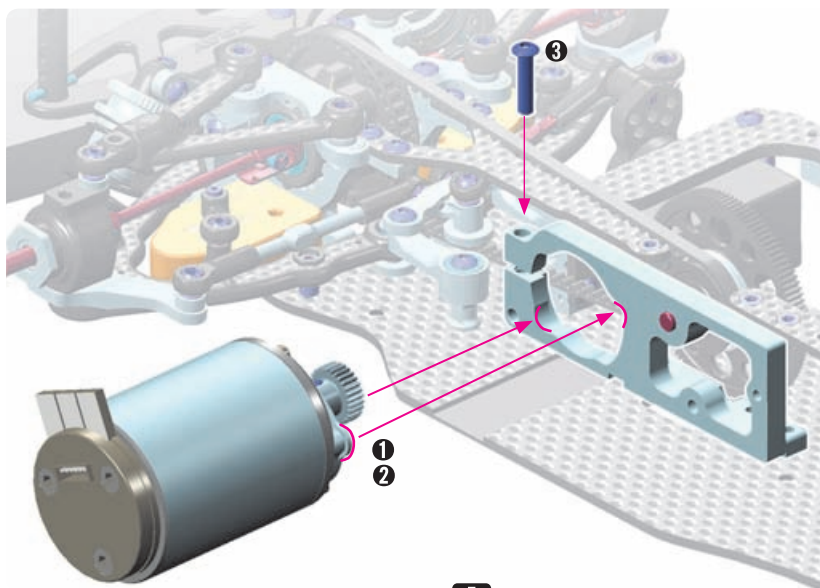

NOTE

The most-used FWD ratios are 4.5 and 5. Use these recommended spur gears and pinions to achieve the desired ratio.

4.5 ratio - 90T spur / 38T pinion
5 ratio - 100T spur / 38T pinion

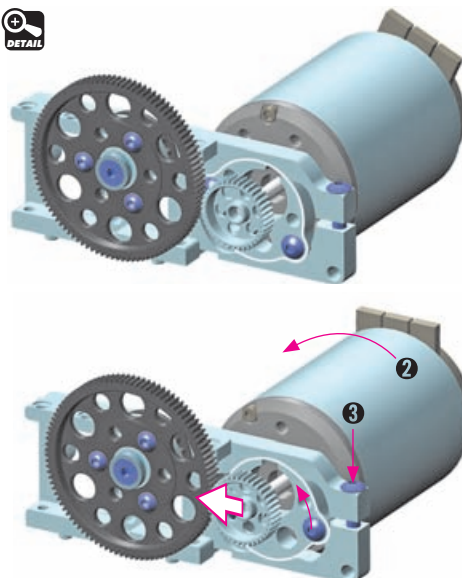

1 Attach the motor to the eccentric motor holder in the indicated orientation. Tighten the mounting screws.

2 Adjust the gear mesh by rotating the eccentric motor holder.

3 Tighten the clamp screw.

2 Adjust the motor so the pinion meshes with the spur gear properly. Make sure the gear mesh is not too tight. There should be a small amount of play between the teeth of the pinion gear and the spur gear.

7. FINAL ASSEMBLY



903308
SFH M3x8



VIDEO TECH TIP



WEIGHT BALANCE



ELECTRONICS
INSTALLATION

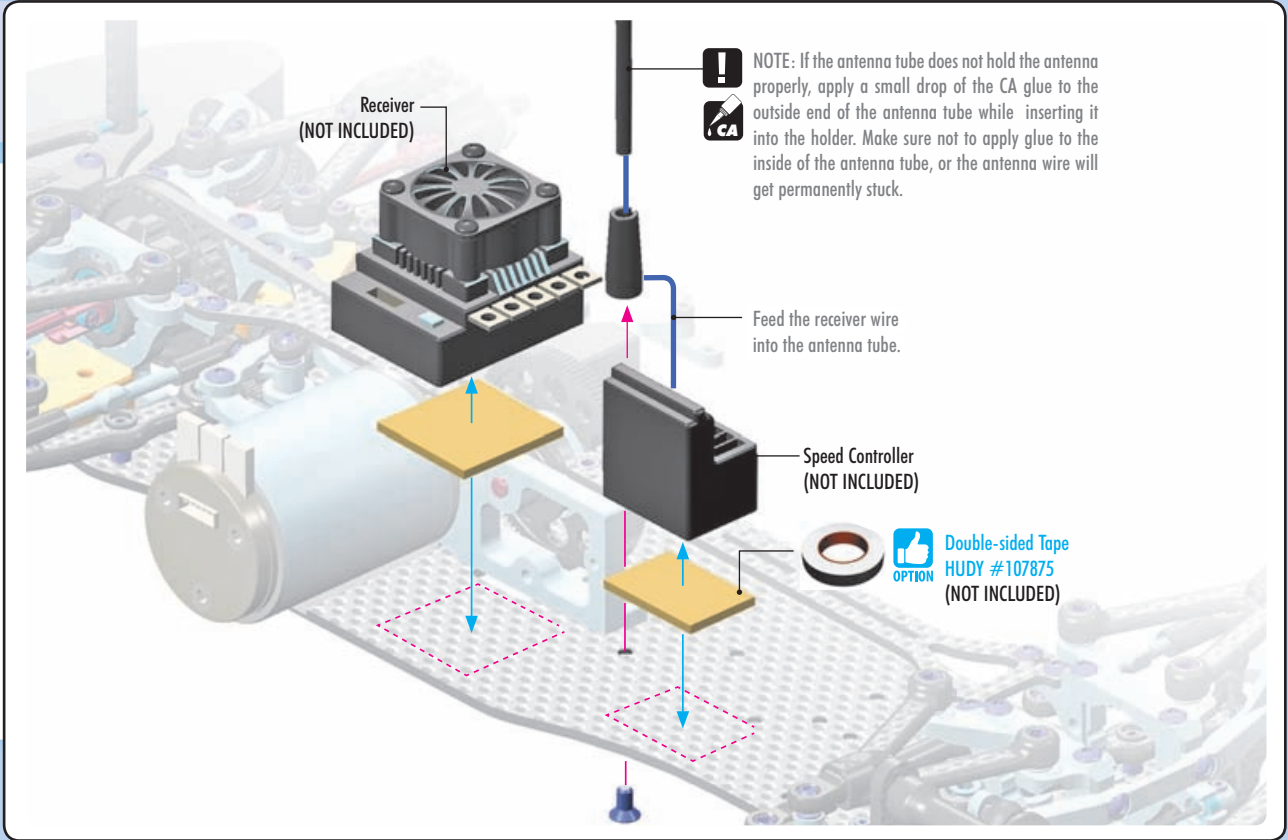

OPTION

FORWARD ALU FAN MOUNT ALTERNATIVE

There are two options how to mount the fan mount depending of the style and size of the fan. Either in front or behind the motor. If you are using HUDY fan, we recommend to use FORWARD mount as it keeps the weight of the car as much in front as possible.

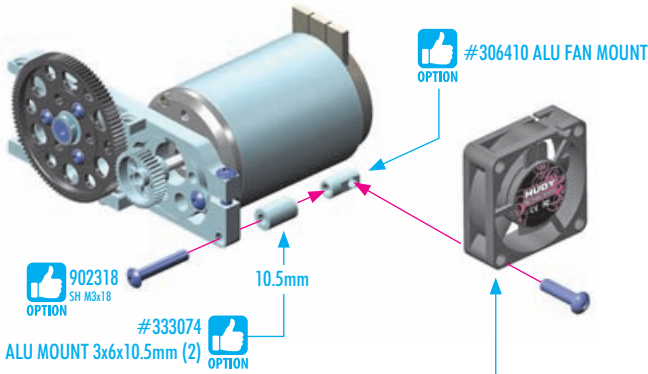

REARWARD ALU FAN MOUNT ALTERNATIVE

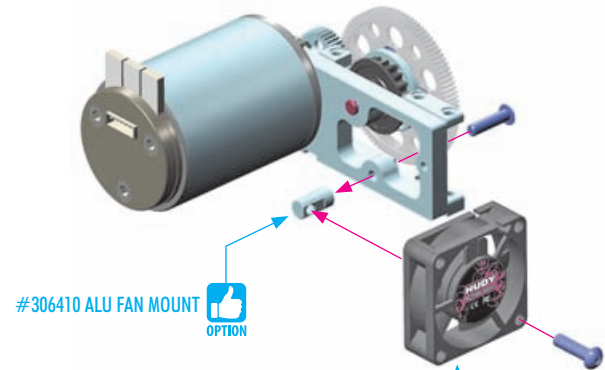

- #293101 HUDY ALU RC FAN 30MM - SIDE MOUNT 2 HOLE**
- #293110 HUDY BRUSHLESS RC FAN 30mm WITH EXTERNAL SOLDERING TABS**
- #293111 HUDY BRUSHLESS RC FAN 40mm WITH EXTERNAL SOLDERING TABS**
- #293112 HUDY BRUSHLESS RC FAN 30mm WITH INTERNAL SOLDERING TABS**
- #293113 HUDY BRUSHLESS RC FAN 40mm WITH INTERNAL SOLDERING TABS**



901305
SB M3x5



902320
SH M3x20



VIDEO TECH TIP



BATTERY MOUNTING
SYSTEM

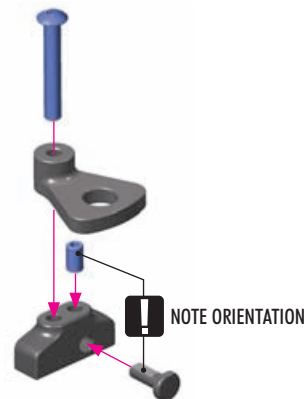

! To ensure correct functioning of the battery holder, **DO NOT** overtighten the screw; the holder must be able to move.

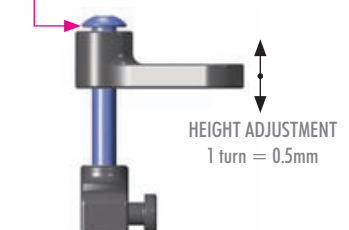

7. FINAL ASSEMBLY



303122-K
SHIM 3x6x1



902306
SH M3x6

903306
SFH M3x6



903312
SFH M3x12



VIDEO TECH TIP



WEIGHT BALANCE

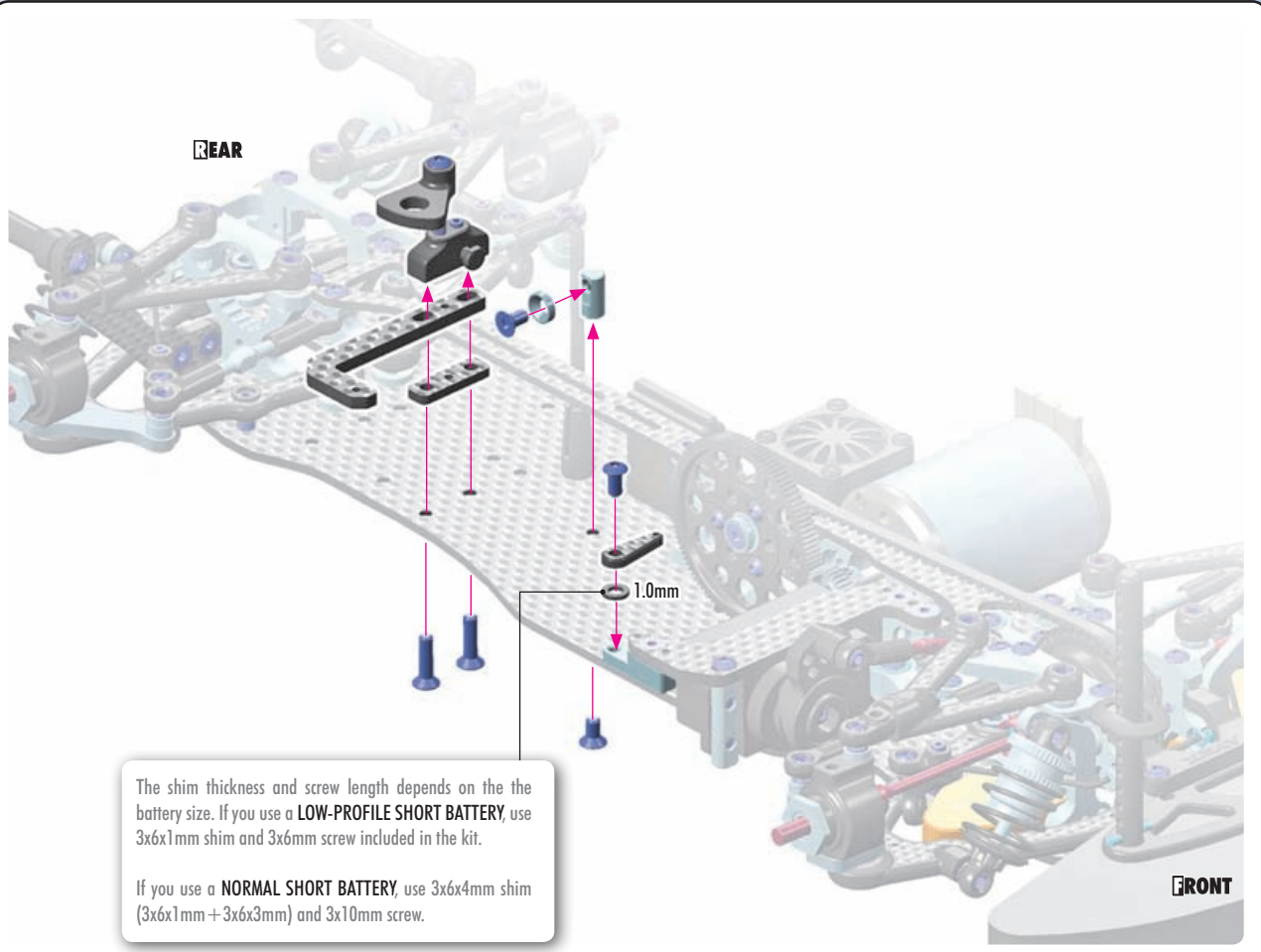

VIDEO TECH TIP



BATTERY MOUNTING SYSTEM

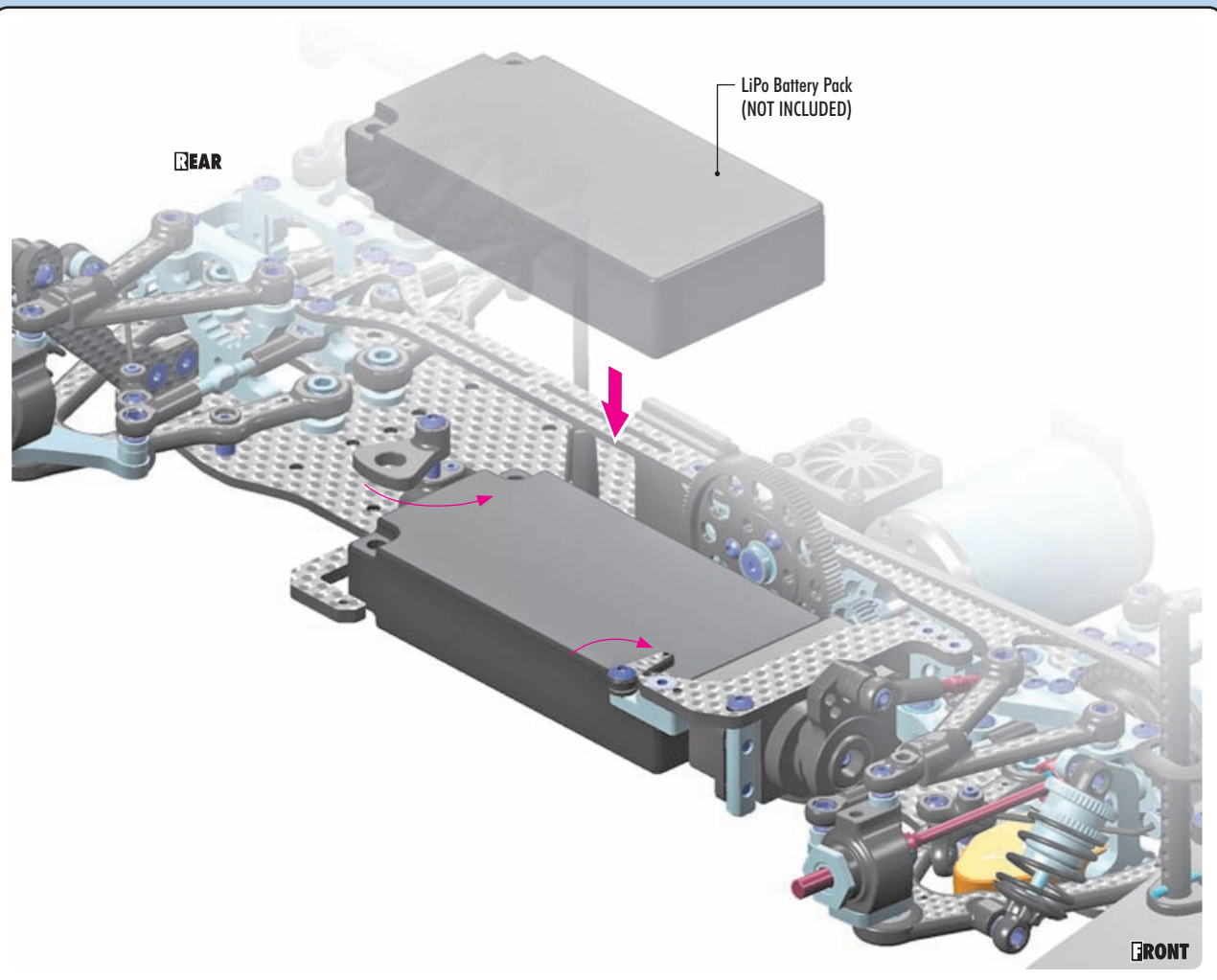

7. FINAL ASSEMBLY

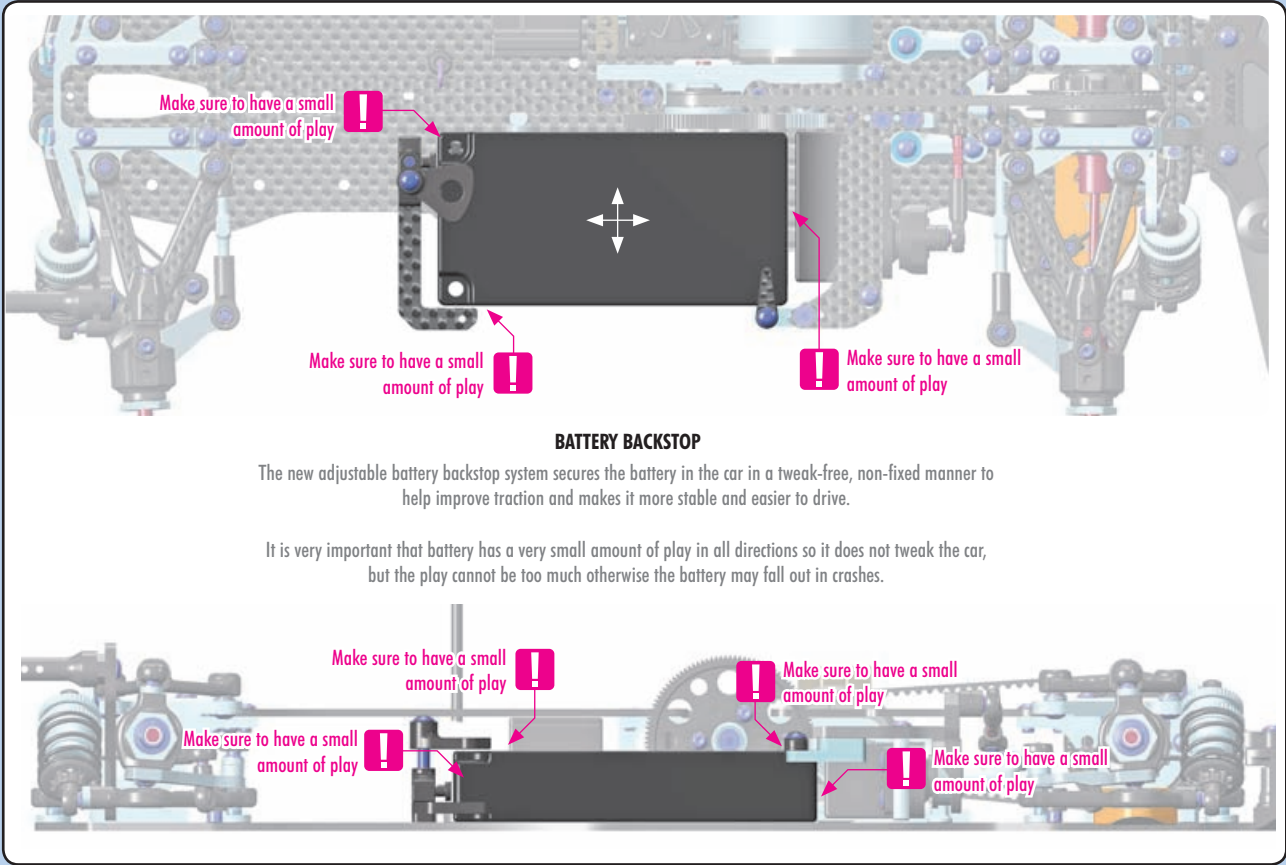

BATTERY BACKSTOP

The new adjustable battery backstop system secures the battery in the car in a tweak-free, non-fixed manner to help improve traction and makes it more stable and easier to drive.

It is very important that battery has a very small amount of play in all directions so it does not tweak the car, but the play cannot be too much otherwise the battery may fall out in crashes.



960240
N M4



VIDEO TECH TIP



TRACK WIDTH
(OFFSET)



DOWNSTOP & RIDE
HEIGHT

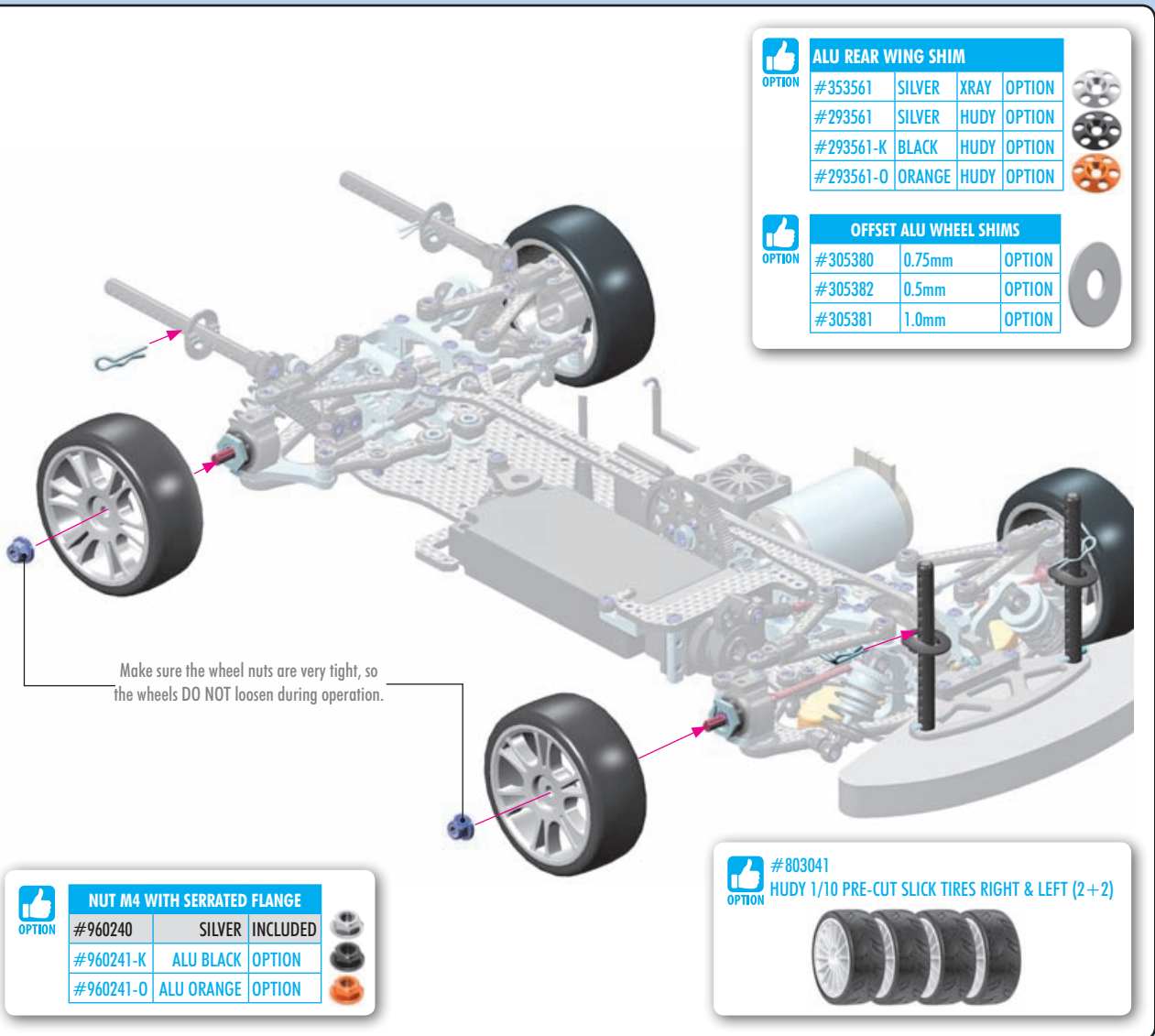

OPTION	ALU REAR WING SHIM			
#353561	SILVER	XRAY	OPTION	
#293561	SILVER	HUDY	OPTION	
#293561-K	BLACK	HUDY	OPTION	
#293561-O	ORANGE	HUDY	OPTION	

OPTION	OFFSET ALU WHEEL SHIMS		
#305380	0.75mm	OPTION	
#305382	0.5mm	OPTION	
#305381	1.0mm	OPTION	

OPTION	NUT M4 WITH SERRATED FLANGE			
#960240	SILVER	INCLUDED		
#960241-K	ALU BLACK	OPTION		
#960241-O	ALU ORANGE	OPTION		

OPTION	#803041	
	HUDY 1/10 PRE-CUT SLICK TIRES RIGHT & LEFT (2+2)	



OPTION

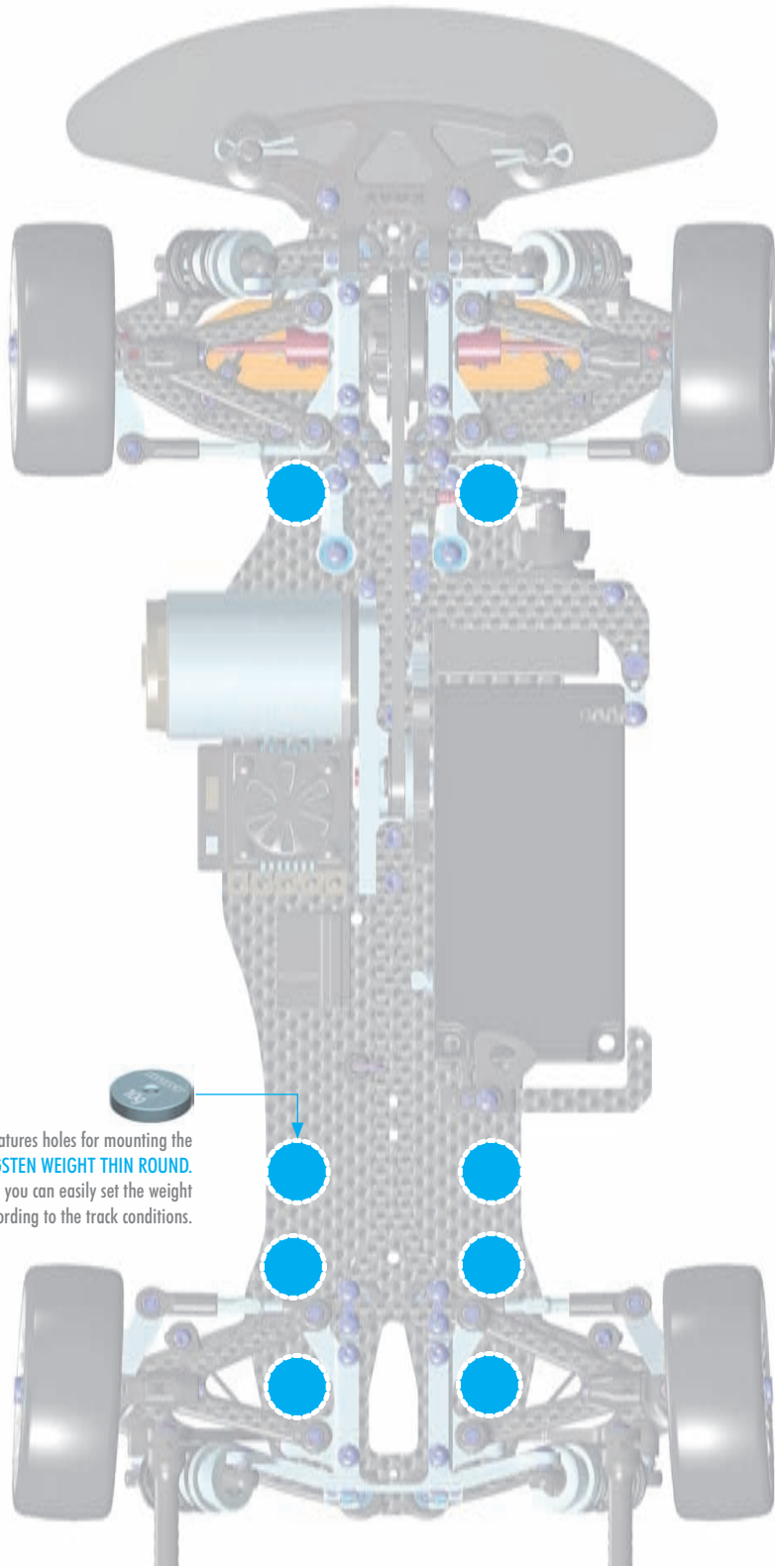

The chassis features holes for mounting the #293085 - HUDY PURE TUNGSTEN WEIGHT THIN ROUND. Thanks to these positions you can easily set the weight balance of the car according to the track conditions.



VIDEO TECH TIP



CHASSIS TWEAK



#326181
STAINLESS STEEL
BATTERY WEIGHT 35g



#293083
HUDY PURE TUNGSTEN
WEIGHT 15g



#293085
HUDY PURE TUNGSTEN
WEIGHT THIN ROUND
WITH M3 - 10g



#293081
HUDY PURE TUNGSTEN
WEIGHT 5g



#293082
HUDY PURE TUNGSTEN
WEIGHT 10g





BODY STOP SYSTEM

The X4F features an adjustable front body upstop system incorporated into the new upper arm to prevent the body shell from bottoming out and hitting the ground during cornering. When the system is set correctly, it allows the body to be run lower without dragging on the ground to improve aerodynamic efficiency.



BODY STOP ALTERNATIVE
with screw and ball joint
(#901308 SB M3x8mm / #303457 Ball Joint)



BODY STOP ALTERNATIVE
with screw
(#902316 SH M3x16mm)

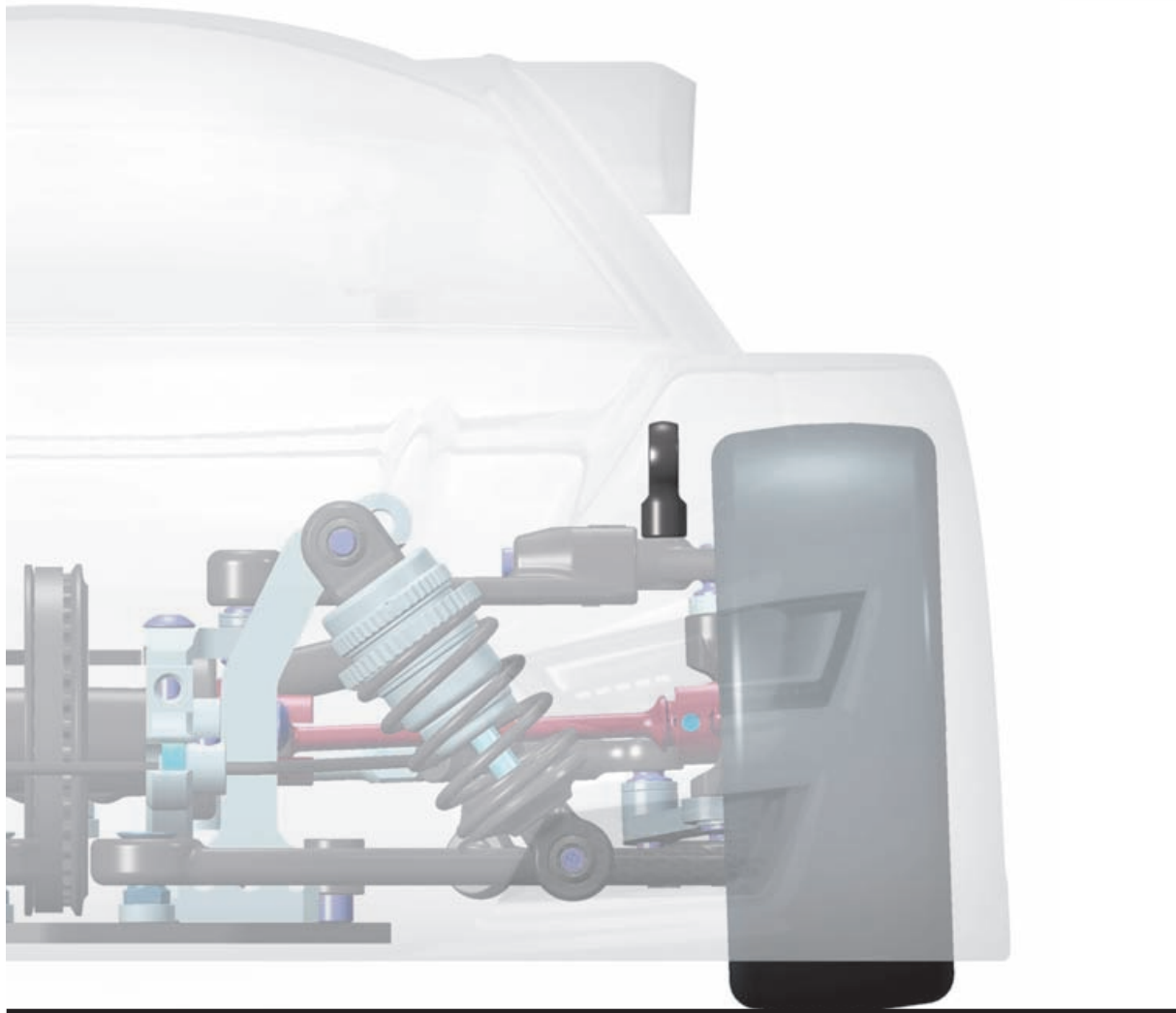
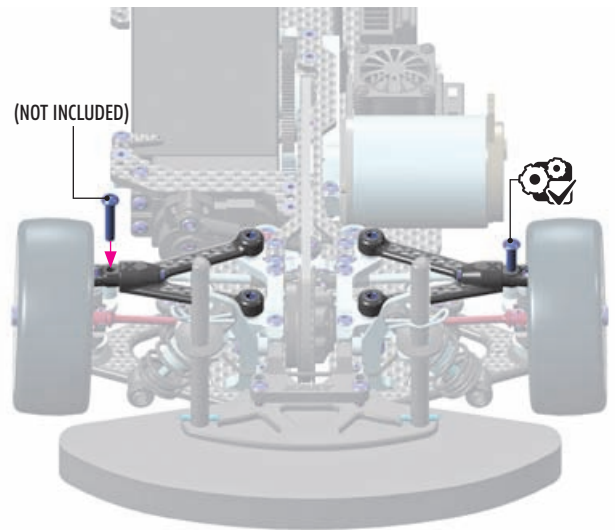
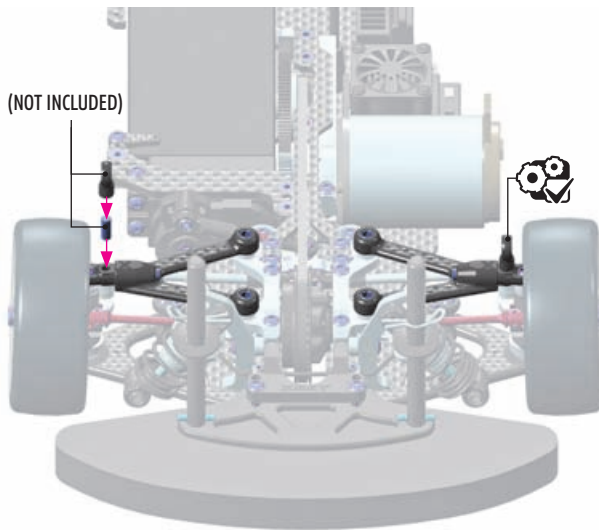

VIDEO TECH TIP



REAR BODY POST MOUNTING

EXCLUSIVE PROFESSIONAL

HUDY

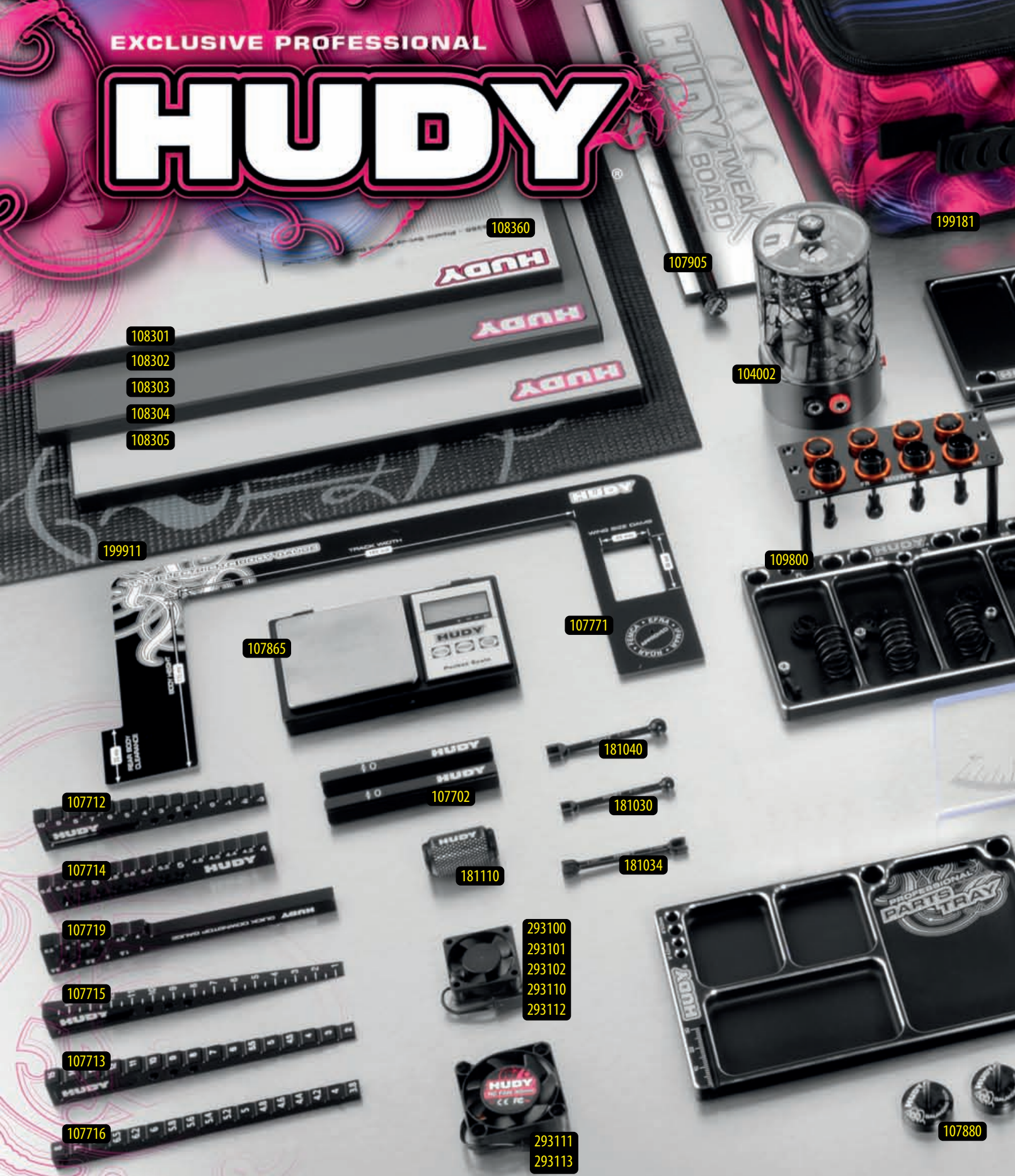

104002 HUDY AIR VAC - VACUUM PUMP - ON-ROAD
 106260 HUDY TIRE ADDITIVE - TIRE GRIPPER - 50ML - V2
 107090 HUDY BEARING CHECKING TOOL
 107601 LIMITED EDITION - REAMER FOR BODY 0-9MM + COVER - SMALL
 107643 LIMITED EDITION - ARM REAMER # 3.0MM
 107702 CHASSIS DROOP GAUGE SUPPORT BLOCKS FOR 1/10 (2)
 107712 CHASSIS DROOP GAUGE -3.0-10MM FOR 1/10 CARS (10MM)
 107713 CHASSIS RIDE HEIGHT GAUGE STEPPED 2.0-15.0MM
 107714 ULTRA-FINE CHASSIS DROOP GAUGE 4.0-6.6MM
 107715 CHASSIS RIDE HEIGHT GAUGE 1.0-15.0MM (BEVELED)
 107716 ULTRA-FINE CHASSIS RIDE HEIGHT GAUGE 3.8-8.0MM
 107719 QUICK DOWNSTOP GAUGE TOOL 1.0-6.5MM
 107720 CHASSIS RIDE HEIGHT GAUGE 30-17MM FOR 1/8 & 1/10 OFF-ROAD
 107750 HUDY GRAPHITE QUICK CAMBER GAUGE 1.5°, 2°, 2.5° FOR 1/10 TC

107771 HUDY BODY GAUGE 1/10 ELECTRIC TOURING CARS
 107855 HUDY PIT LED
 107865 HUDY PROFESSIONAL DIGITAL POCKET SCALE 300G/0.01G
 107870 HUDY FIBRE-REINFORCED TAPE - BLACK
 107875 HUDY ULTRA DOUBLE-SIDED TAPE
 107880 CHASSIS BALANCING TOOL (2)
 107904 HUDY QUICK-TWEAK STATION 1/10 & 1/12 ON-ROAD
 107905 HUDY TWEAK BOARD SET
 108150 HUDY 1/10 TOURING CAR STAND - V3
 108190 HUDY ALU PARTS TRAY 160x100MM
 108192 HUDY ALU PARTS TRAY NARROW 215x50MM
 108193 HUDY ALU PARTS TRAY LARGE 215x100MM
 108301 FLAT SET-UP BOARD 1/10 & 1/12 - LIGHTWEIGHT - GREY
 108302 FLAT SET-UP BOARD 1/10 & 1/12 - LIGHTWEIGHT - SILVER GREY

108303 FLAT SET-UP BOARD 1/10 & 1/12 - LIGHTWEIGHT - BLACK
 108304 FLAT SET-UP BOARD 1/10 & 1/12 - LIGHTWEIGHT - RED
 108305 FLAT SET-UP BOARD 1/10 & 1/12 - LIGHTWEIGHT - BLUE
 108360 PLASTIC SET-UP BOARD DE
 109301 HUDY SET-UP STATION FOR
 109360 ALU NUT FOR 1/10 TOURING
 109370 ALU SET-UP WHEEL FOR 1/10
 109800 HUDY ALU TRAY FOR ON-ROAD
 109840 HUDY ALU TRAY FOR 1/10
 109860 HUDY ALU TRAY FOR 1/10
 109880 HUDY ALU TRAY FOR ACCESSORIES
 111545 LIMITED EDITION - ALLEN
 112045 LIMITED EDITION - ALLEN
 113045 LIMITED EDITION - ALLEN

108301
 108302
 108303
 108304
 108305

199911

107865

107771

107712

181040

107714

107702

181030

107719

181110

181034

107715

293100
 293101
 293102
 293110
 293112

107713

293111
 293113

107716

107880

107905

104002

109800

199181



& 1/12 - LIGHTWEIGHT - DARK GREY
 & 1/12 - LIGHTWEIGHT - TITAN
 & 1/12 - LIGHTWEIGHT - BLACK
 CAL 282X386MM - 1/10 TC
 R 1/10 TOURING CARS
 G SET-UP SYSTEM (4)
 10 RUBBER TIRES (4)
 ROAD DIFF & SHOCKS
 OFF-ROAD DIFF ASSEMBLY
 IP SYSTEM
 SSORIES & PIT LED
 WRENCH # 1.5MM
 WRENCH # 2.0MM
 WRENCH # 3.0MM

132045 LIMITED EDITION - ALLEN WRENCH + BALL REPL. TIP # 2.0MM
 175535 LIMITED EDITION - SOCKET DRIVER # 5.5MM
 177035 LIMITED EDITION - SOCKET DRIVER # 7.0MM
 181030 HUDY SPRING STEEL TURNBUCKLE WRENCH 3 MM
 181034 TURNBUCKLE WRENCH 3 & 4MM - HUDY SPRING STEEL™
 181040 TURNBUCKLE WRENCH 4MM - HUDY SPRING STEEL™
 181110 HUDY BALL JOINT WRENCH
 183011 HUDY PROFESSIONAL MULTI TOOL
 188981 HUDY POCKET HOBBY KNIFE
 188990 HUDY PROFESSIONAL BODY SCISSORS
 199060 HUDY ALU TOOL STAND
 199181 HUDY CAR BAG - 1/10 ON-ROAD - TC - PAN CAR - CUSTOM NAME
 199270 HUDY LIPO SAFETY BAG - CUSTOM NAME
 199911 HUDY PIT MAT ROLL 750x1200MM WITH PRINTING

293100 HUDY ALU RC FAN 30MM - BOTTOM MOUNT 2 HOLE
 293101 HUDY ALU RC FAN 30MM - SIDE MOUNT 2 HOLE
 293102 HUDY ALU RC FAN 30MM - TOP/SIDE MOUNT 4 HOLE
 293110 HUDY BRUSHLESS RC FAN 30mm - WITH EXTERNAL SOLDERING TABS
 293111 HUDY BRUSHLESS RC FAN 40mm - WITH EXTERNAL SOLDERING TABS
 293112 HUDY BRUSHLESS RC FAN 30mm - WITH INTERNAL SOLDERING TABS
 293113 HUDY BRUSHLESS RC FAN 40mm - WITH INTERNAL SOLDERING TABS
 298100 HUDY TIN ROUND BOX 80x30mm

For more information about tools, set-up equipment and accessories suitable for your car please visit:

www.hudy.net



EXCLUSIVE PROFESSIONAL

HUDY

HUDY

199295-H

199290-H

106261

106200

803041

107861

107840

105590

107846

107761

293080

106290

293012

293011

293083

293082

293081

293084

294017~294035

294127~294160

- | | | | |
|--------|---|--------|---|
| 107761 | HUDY ADJUSTABLE CAMBER GAUGE 80MM | 105590 | HUDY WHEEL BALANCING PUTTY |
| 107772 | HUDY PROFESSIONAL 1/10 TC WHEEL ARCH MARKER + WHEEL ADAPTER & NUT | 181090 | HUDY SPECIAL TOOL FOR TURNBUCKLES & NUTS |
| 106210 | HUDY GRAPHITE GREASE | 181091 | HUDY TURNBUCKLE WRENCH 3 & 4MM - V2 |
| 106230 | HUDY BEARING OIL | 803041 | HUDY 1/10 PRE-CUT SLICK TIRES RIGHT & LEFT (2+2) |
| 106200 | HUDY MAGIC CLEANING GUM | 293011 | HUDY STAINLESS STEEL BATTERY WEIGHT 35G |
| 106261 | HUDY TIRE ADDITIVE - TIRE GRIPPER RED - 50ML | 293012 | HUDY STAINLESS STEEL BATTERY WEIGHT FOR NARROW BATTERY PACK 35G |
| 106350 | HUDY PREMIUM SILICONE OIL 500 CST - 50ML | 293080 | LEAD WEIGHTS 4x5G & 4x10G WITH 3M GLUE |
| 107861 | HUDY PROFESSIONAL RACING STOPWATCH XL DISPLAY | 293081 | HUDY PURE TUNGSTEN WEIGHT 5G |
| 106290 | HUDY PROFESSIONAL SOLDER 3M LENGTH | 293082 | HUDY PURE TUNGSTEN WEIGHT 10G |
| 107840 | CLEANING BRUSH LARGE - SOFT | 293083 | HUDY PURE TUNGSTEN WEIGHT 15G |
| 107846 | CLEANING BRUSH SMALL - SOFT | 293084 | PRECISION BALANCING CHASSIS WEIGHT 10G (4) |
| 105520 | WHEEL ADAPTER FOR 1/10 ON-ROAD & 1/10 OFF-ROAD - 12MM | 293311 | GRAPHITE REAR WING SIDE PLATE 0.5MM - 1/10 ELECTRIC (2) |



199280M-H



199296-H



298015



105520

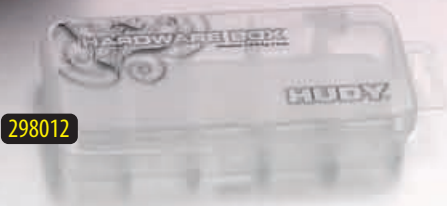

298012



298016



298018



298019



107772



298017



298014



181090



106310~106694



293311



298013



293491~293493

293401~293403



293497~293499

293404~293406



293501~293503

293407~293409



181091



106210



106230



- 293403 ALU CLAMP SERVO HORN - FUTABA, SAVÖX - OFFSET 1-HOLE M3 - 25T
- 293493 ALU SERVO HORN - FUTABA, SAVÖX - OFFSET 1-HOLE M3 - 25T - V2
- 294023 HUDY ALU ULTRA-LIGHT PINION GEAR - HARD COATED - 23T / 48
- 294140 HUDY ALU ULTRA-LIGHT PINION GEAR - HARD COATED - 40T / 64
- 294156 HUDY ALU ULTRA-LIGHT PINION GEAR - HARD COATED - 56T / 64
- 298012 HUDY PARTS BOX - 10-COMPARTMENTS
- 298013 HUDY SPRINGS BOX - 10-COMPARTMENTS
- 298014 HUDY PARTS BOX - 8-COMPARTMENTS
- 298015 HUDY PARTS CASE - 290 x 195MM
- 298016 HUDY TINY HARDWARE BOX - 4-COMPARTMENTS
- 298017 HUDY TINY ONE-PIECE HARDWARE BOX - 8-COMPARTMENTS
- 298018 HUDY TINY HARDWARE BOX - 8-COMPARTMENTS

- 298019 HUDY DIFF BOX - 8-COMPARTMENTS
- 199280M-H HUDY HARD CASE - 140x110x95MM - OIL BAG MEDIUM
- 199290-H HUDY HARD CASE - 235x190x75MM - ACCESSORIES / ENGINE BAG
- 199295-H HUDY HARD CASE - 280x150x85MM - ACCESSORIES BAG LARGE
- 199296-H HUDY HARD CASE - 120x85x46MM - ACCESSORIES / STOP WATCH

For more information about tools, set-up equipment & accessories suitable for your car please visit:

www.hudy.net

X4F'24



www.teamxray.com

XRAY EUROPE

XRAY, K VÝSTAVISKU 6992, 91101 TRENCIN, SLOVAKIA, EUROPE
 PHONE: +421-32-740 11 00, FAX: +421-32-740 11 09, info@teamxray.com

XRAY USA

RC AMERICA, 2030 Century Center Blvd #15, Irving, TX 75062, USA
 PHONE: 214-744-2400, FAX: 214-744-2401, xray@rcamerica.com

