

# BOOMERANG 40

SPORTS TRAINER - ENGINE SIZE.40 - .46 - 2STROKE  
Hand-made Almost Ready to Fly R/C Model Aircraft

## ASSEMBLY MANUAL



### Specifications

Wing span \_\_\_\_\_ 155cm.  
Wing area \_\_\_\_\_ 4185 sq. cm.  
Approximate flying weight \_\_\_\_\_ 2.6-2.8kg.  
Recommended engine size 0.40-0.46 cu. ins 2-stroke.  
10cc gasoline.  
Recommended R/C \_\_\_\_\_ 4 channels minimum.  
Flying skill level \_\_\_\_\_ Sports Trainer.  
Electric conversion: optional

### Additional items required.

Engine.  
4 Channels or greater Radio Control system.  
Glues.  
Tools.  
Starting Equipment.

### Kit features.

- Ready-made—minimal assembly & finishing required.
- Ready-covered—including decals, trim & covering.
- Factory-installed pushrod.
- Factory-pinned & glued control surface hinges for ultimate safety.
- Comprehensive hardware pack including wheels, tank, spats, undercarriage & spinner.
- Photo-illustrated step-by-step Assembly Manual.

Made in Vietnam.

## INTRODUCTION.

Thank you for choosing the **Boomerang 40** ARTF by SG MODELS. The **Boomerang 40** was designed with the sports trainer flyer in mind. It is a High-wing aeroplane which is easy to fly and quick to assemble. The airframe is conventionally built using balsa, plywood and veneer to make it stronger than the average ARTF, yet the design allows the aeroplane to be kept light. You will find that most of the work has been done for you already. The pushrods are pre-made to the correct lengths, the motor mount has been fitted and the hinges are pre-installed and pinned for security. Flying the **Boomerang 40** is simply a joy.

This instruction manual is designed to help you build a great flying aeroplane. Please read this manual thoroughly before starting assembly of your **Boomerang 40**. Use the parts listing below to identify all parts.

## WARNING.

Please be aware that this aeroplane is not a toy and if assembled or used incorrectly it is capable of causing injury to people or property. WHEN YOU FLY THIS AEROPLANE YOU ASSUME ALL RISK & RESPONSIBILITY.

If you are inexperienced with basic R/C flight we strongly recommend you contact your R/C supplier and join your local R/C Model Flying Club. R/C Model Flying Clubs offer a variety of training procedures designed to help the new pilot on his way to successful R/C flight. They will also be able to advise on any insurance and safety regulations that may apply.

## ADDITIONAL ITEMS REQUIRED.

- .40-.46 2-stroke engine.
- 4 channels radio with four servos.
- Glow plug to suit engine.
- Propeller to suit engine.
- Protective foam rubber for radio system.
- Silicone fuel line.
- Stick-on weights for balance (If necessary).

## TOOLS &amp; SUPPLIES NEEDED.

- Thick cyanoacrylate glue.
- 30 minute epoxy.
- 5 minute epoxy.
- Hand or electric drill.
- Assorted drill bits.
- Modelling knife.
- Straight edge ruler.
- 2mm ball driver.
- Phillips head screwdriver.
- 220 grit sandpaper.
- 90° square or builder's triangle.
- Wire cutters.
- Masking tape & T-pins.
- Thread-lock.
- Paper towels.

## PARTS LISTING.

## FUSELAGE ASSEMBLY

- (1) Fuselage.
- (1) Pre-installed throttle pushrod & tube.
- (1) Pre-installed servo tray.
- (1) Pre-installed motor mount.
- (1) Pre-installed rudder pushrod.
- (1) Pre-installed elevator pushrod.

## WING ASSEMBLY

- (1) Right wing half with pre-installed aileron.
- (1) Left wing half with pre-installed aileron.
- (1) Aluminium wing tube.
- (1) Covering strip for centre section joint.

## TAIL SECTION ASSEMBLY

- (1) Vertical stabilizer with pre-installed rudder.
- (1) Horizontal stabilizer with pre-installed elevator halves.

**NOTE:** To avoid scratching your new aeroplane we suggest that you cover your workbench with an old towel. Keep a couple of jars or bowls handy to hold the small parts after you open the bags.

Please trial fit all parts. Make sure you have the correct parts and that they fit and are aligned properly before gluing! This will ensure proper assembly as the **Boomerang 40** is made from natural materials and minor adjustments may have to be made.

The paint and plastic parts used in this kit are fuel proof. However, they are not tolerant of many harsh chemicals including the following: paint thinner, cyano-acrylate glue accelerator, cyanoacrylate glue de-bonder and acetone. Do not let these chemicals come in contact with the colours on the covering and the plastic parts.

## HINGING THE AILERONS.

**Note:** The control surfaces, including the ailerons, elevators, and rudder, are prehinged with hinges installed, but the hinges are not glued in place. It is imperative that you properly adhere the hinges in place per the steps that follow using a high-quality thin C/A glue.

- 1) Carefully remove the aileron from one of the wing panels. Note the position of the hinges.

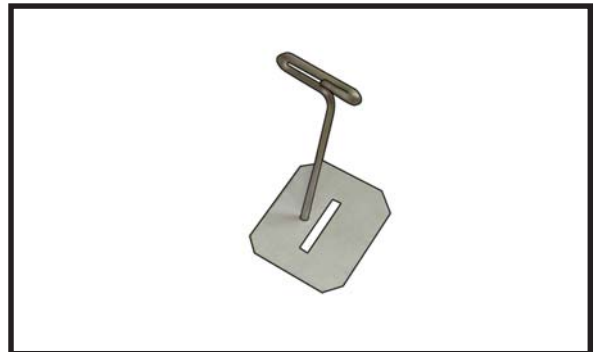

- 2) Remove each hinge from the wing panel and aileron and place a T-pin in the center of each hinge. Slide each hinge into the wing panel until the T-pin is snug against the wing panel. This will help ensure an equal amount of hinge is on either side of the hinge line when the aileron is mounted to the aileron.

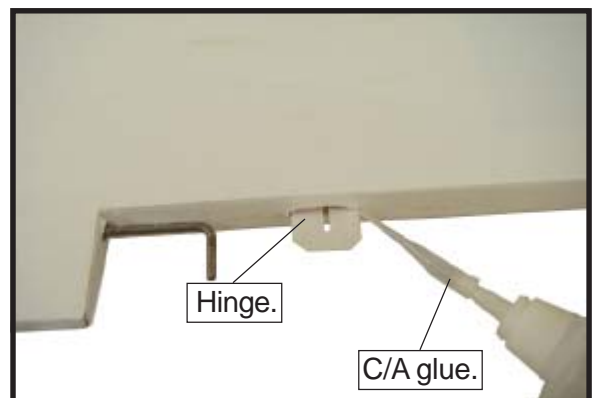

- 3) Slide the wing panel on the aileron until there is only a slight gap. The hinge is now centered on the wing panel and aileron. Remove the T-pins and snug the aileron against the wing panel. A gap of 1/64" or less should be maintained between the wing panel and aileron.

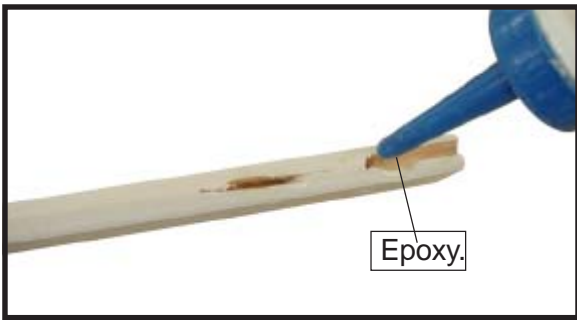

□ 4) Deflect the aileron and completely saturate each hinge with thin C/A glue. The ailerons front surface should lightly contact the wing during this procedure. Ideally, when the hinges are glued in place, a 1/64" gap or less will be maintained throughout the length of the aileron to the wing panel hinge line.

**Note:** *The hinge is constructed of a special material that allows the C/A to wick or penetrate and distribute throughout the hinge, securely bonding it to the wood structure of the wing panel and aileron.*

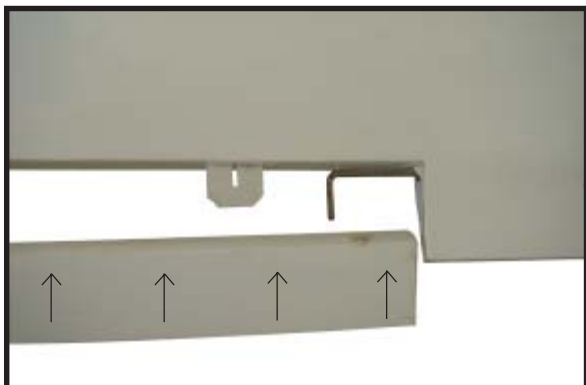

□ 5) Turn the wing panel over and deflect the aileron in the opposite direction from the opposite side. Apply thin C/A glue to each hinge, making sure that the C/A penetrates into both the aileron and wing panel.

□ 6) Using C/A remover/debonder and a paper towel, remove any excess C/A glue that may have accumulated on the wing or in the aileron hinge area.

□ 7) Repeat this process with the other wing panel, securely hinging the aileron in place.

□ 8) After both ailerons are securely hinged, firmly grasp the wing panel and aileron to make sure the hinges are securely glued and cannot be pulled out. Do this by carefully applying medium pressure, trying to separate the aileron from the wing panel. Use caution not to crush the wing structure.



**Note:** *Work the aileron up and down several times to "work in" the hinges and check for proper movement.*

**HINGING THE ELEVATOR.**

Glue the elevator hinges in place using the same techniques used to hinge the ailerons.





## HINGING THE RUDDER.

Glue the rudder hinges in place using the same techniques used to hinge the ailerons.

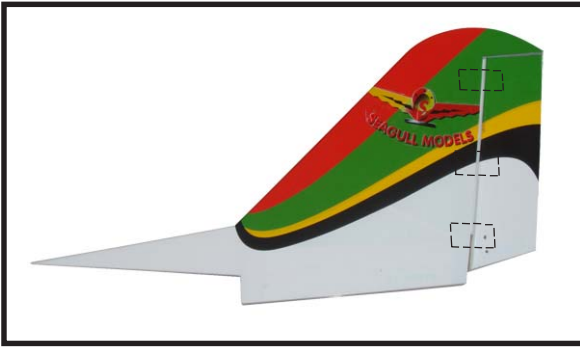

**NOTE:** *We highly recommend using 30 minute epoxy as it is stronger and provides more working time, allowing the builder to properly align the parts. Using fast cure epoxy when joining the wing halves could result in the glue drying before the wing halves are aligned properly which may result in failure of the wing centre section during flight.*

□ 1) Test fit the wing tube into each wing half. The brace should slide in easily up to the centreline that you drew. If not, use 220 grit sandpaper with a sanding block and sand down the edges and ends of the brace until it fits properly.

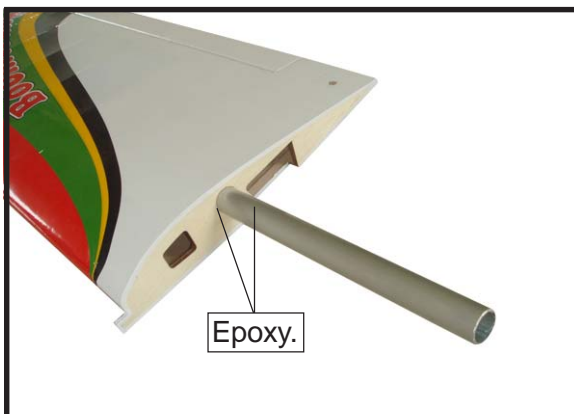
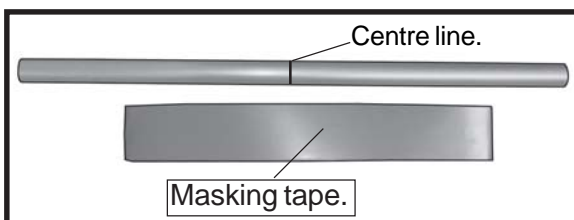

□ 2) Remove the brace when satisfied with its fit in each wing half. Coat both sides of one half of the dihedral brace with 30 minute epoxy. Next, pour some epoxy into the dihedral box in one wing panel. Make sure you cover the top and bottom as well as the sides of the dihedral brace. Use enough epoxy to fill any gaps.

Carefully slide the two wing halves together and firmly press them together, allowing the excess epoxy to run out. There should not be any gap in the wing halves. Use rubbing alcohol and a paper towel to clean up any excess epoxy.

Apply masking tape at the wing join to hold the wing halves together securely.

□ 3) Peel off the backing from the self adhesive covering strip. Apply the strip to the centre section of the wing starting from the bottom trailing edge. Wrap the strip all the way around the wing until it meets the trailing edge again. Trim off any excess strip.

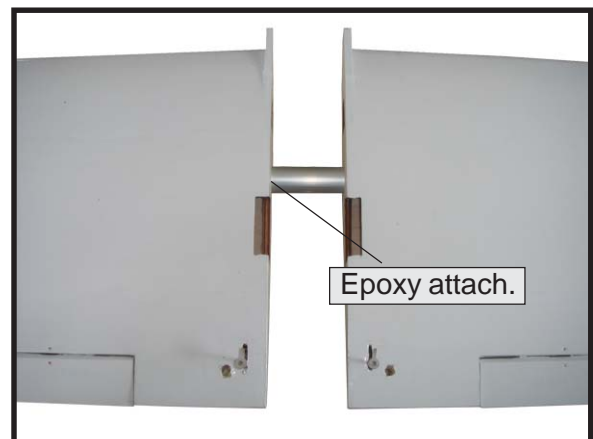

4. Once the epoxy has cured, trial fit both wing halves together. The centre ribs should fit together flush with no gaps. If gaps do exist, use 220 grit sandpaper and sand down the high spots on the root ribs and the wing joiner until a proper fit is achieved. The correct amount of dihedral is ready-built into the wings. With one wing half laid flat on the table, the other wing tip should be off the table surface. If this needs to be adjusted, you may do so by sanding small amounts from the centre ribs or dihedral brace.

5. Carefully apply masking tape around the top and bottom edge of the root rib of each wing half to protect them from damage caused by epoxy.

6. Mix a generous amount of 30 minute epoxy. Coat the exposed half of the dihedral brace, and the remaining wing joiner box and both root ribs with epoxy. Slide the two wing halves together and carefully align them at the leading and trailing edges. Wipe away any excess epoxy using paper towels. Use masking tape wrapped around the centre section to hold the halves in place until the epoxy cures.

7. When the epoxy has cured, carefully remove the masking tape from the wing.



8. Peel off the backing from the self adhesive covering strip. Apply the strip to the centre section of the wing starting from the bottom trailing edge. Wrap the strip all the way around the wing until it meets the trailing edge again. Trim off any excess strip.

#### INSTALLING THE AILERON SERVO MOUNT.

1. Install the rubber grommets and brass collets onto the aileron servo. Test fit the servo into the aileron servo mount.

 *Because the size of servos differ, you may need to adjust the size of the pre-cut opening in the mount. The notch in the sides of the mount allow the servo lead to pass through.*

2. Remove the aileron servo. Place the mount onto the wing, aligning the cutout in the mount with the cutout in the wing. The two notches in the mount should face the leading edge of the wing.

3. While holding the servo mount firmly in place, trace around it using a pen.

4. Remove the mount, and using a modeling knife, carefully remove the covering from inside the outline you drew.

5. Using 6 Minute Epoxy, glue the servo mount into place. Remove any excess epoxy using a paper towel and rubbing alcohol. Use pieces of masking tape to hold the tray in place until the epoxy fully cures.

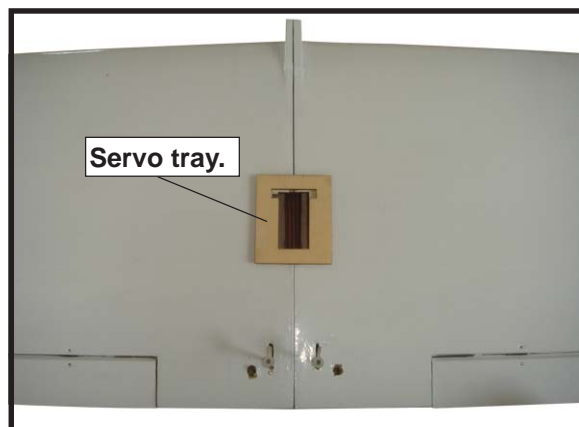
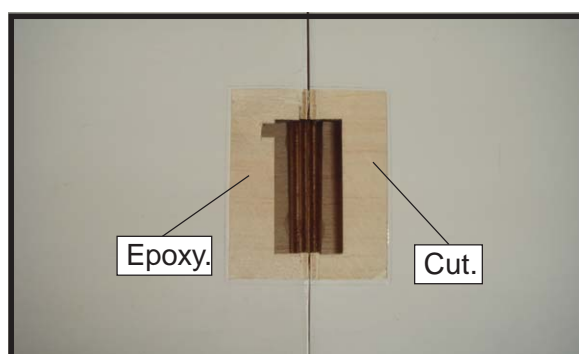
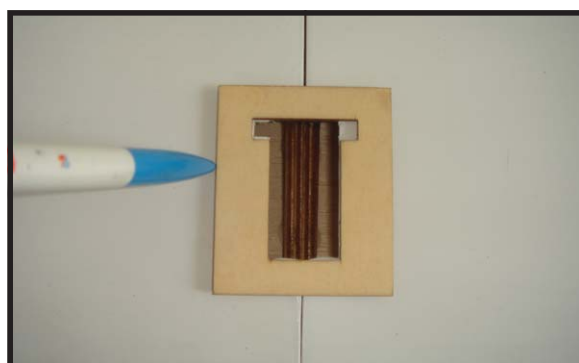

**INSTALLING THE AILERON SERVO.**

Install the aileron servo into the servo mount, with the output shaft towards the leading edge of the wing, using the wood screws provided with your radio system. Drill 1/16" pilot holes through the mount before installing the screws. This will prevent the wood from splitting.

**INSTALLING THE AILERON LINKAGE.**

1. Thread one nylon adjustable control horn onto each aileron torque rod. Thread the horns on until they are flush with the ends of the torque rods.
2. Thread one nylon clevis at least 5/16" onto each of the two threaded wires.
3. With the aileron servo centered, install the servo arm onto the servo. The arm should be installed so it is parallel with the trailing edge of the wing.

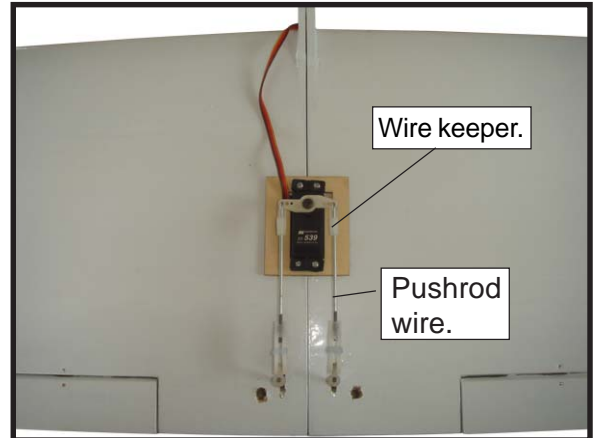
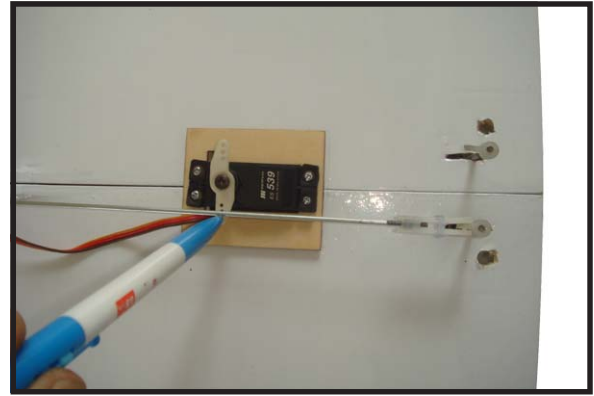
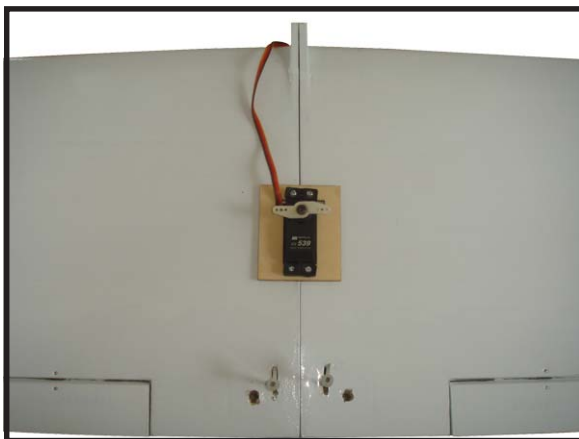

4. Slide the pushrod wires following picture above.
5. With both the aileron servo and the ailerons centered. Tighten the set screws on the connectors.

**INSTALLING THE MAIN LANDING GEAR.**

**NOTE :** You must now decide if you will assemble the Classic Ugly Stick with tri-cycle landing gear or as a tail dragger. If you are assembling as a tail dragger, please skip the nose gear installation steps and mount the main gear to the FORWARD mounting location. If you are assembling using the tri-cycle landing gear, please skip the tail wheel installation steps, Install the nose gear, and mount the main gear to the REAR mounting location.

- 1) The blind nuts for securing the landing gear are already mounted inside the fuselage.

2) Using the hardware provided, mount the main landing gear to the fuselage.

3) Place the fuselage inverted on the work bench in a suitable stand. Set the landing gear in place and use a screwdriver to secure the landing gear to the fuselage using bolts M4x20mm and washers. Make sure to use the threadlock on the bolts so they don't vibrate loose.

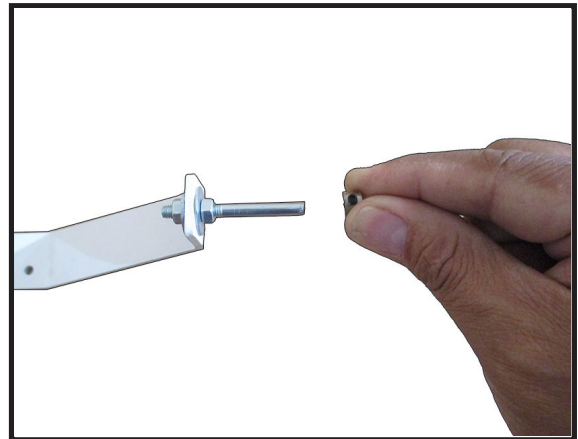
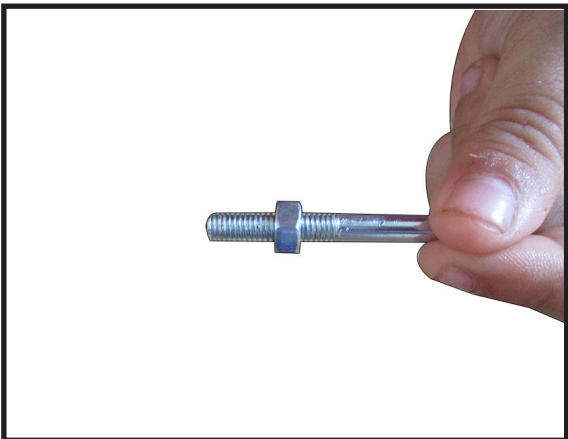
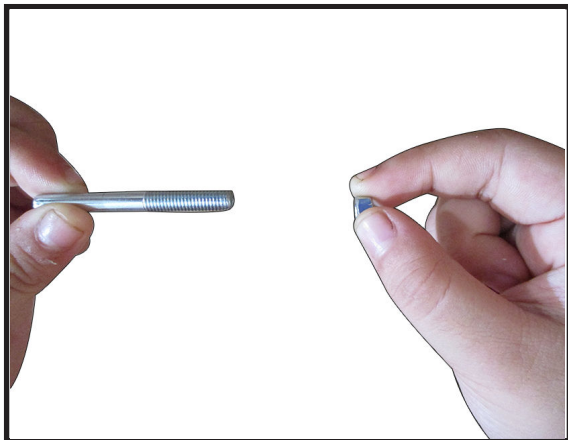
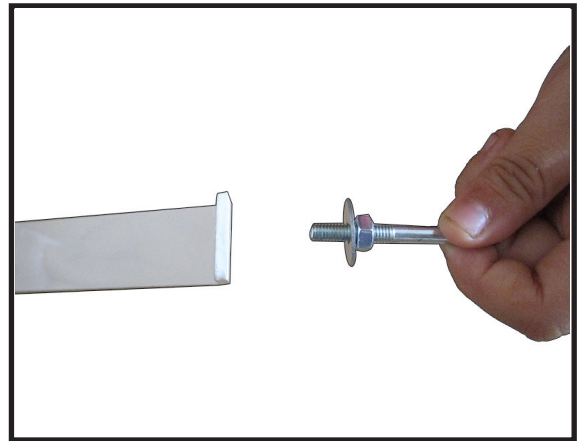
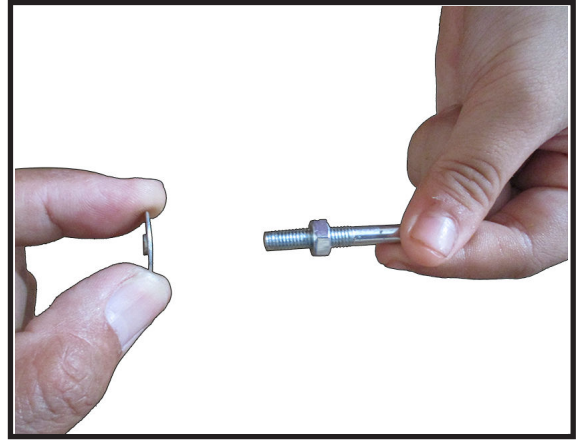
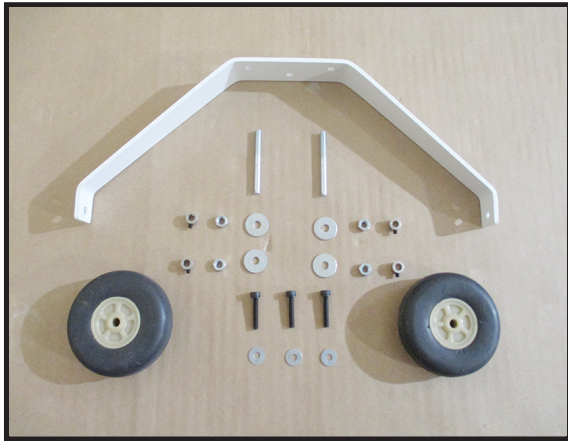



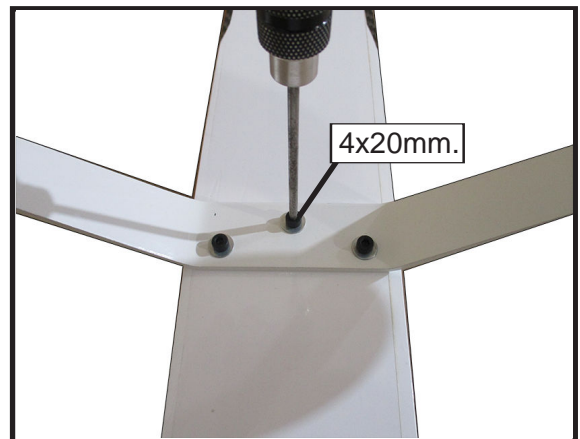
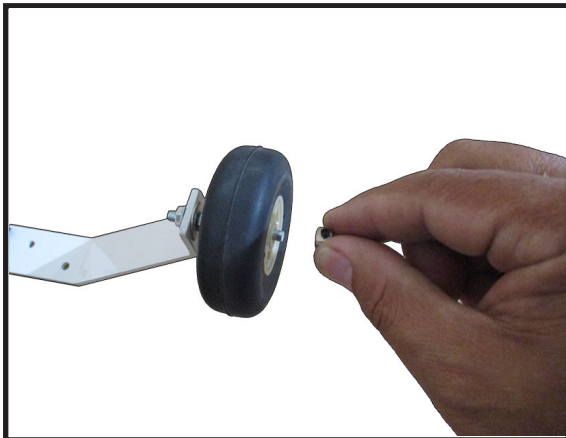
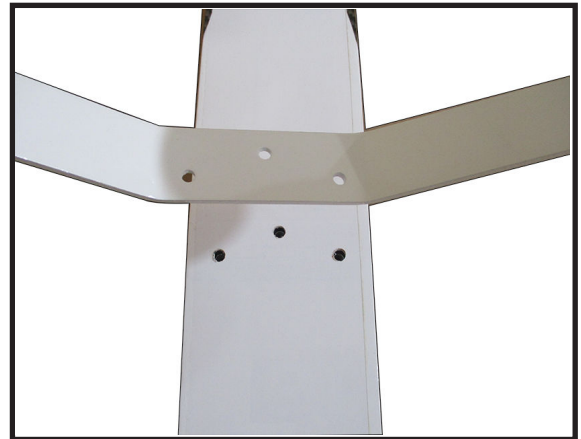
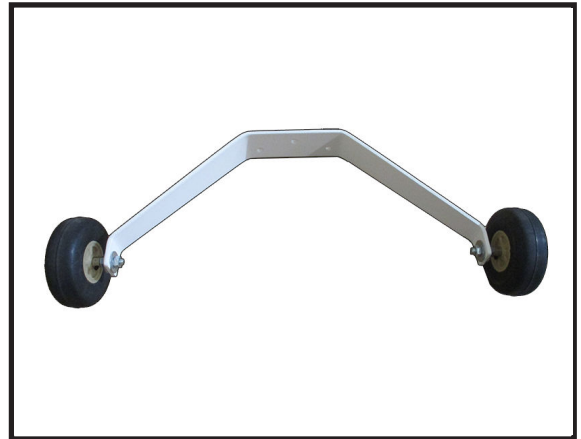
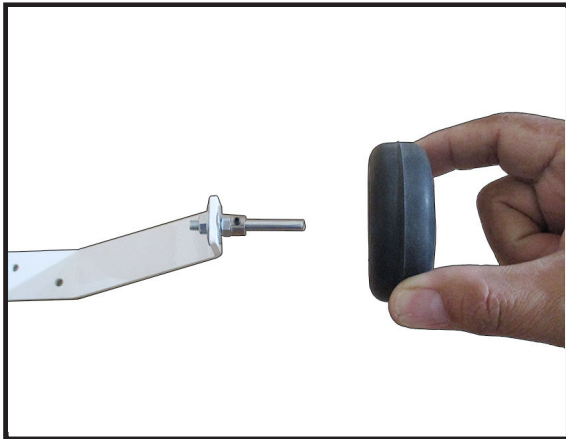
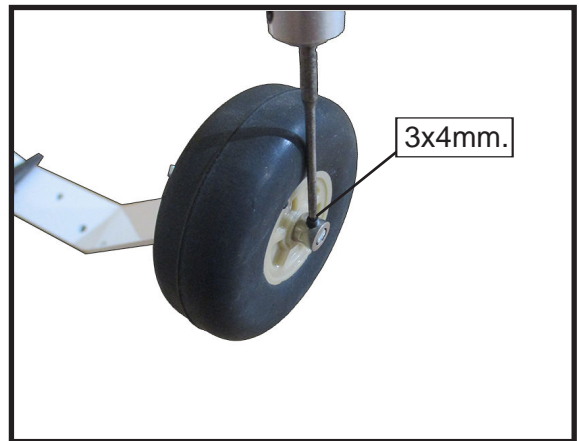

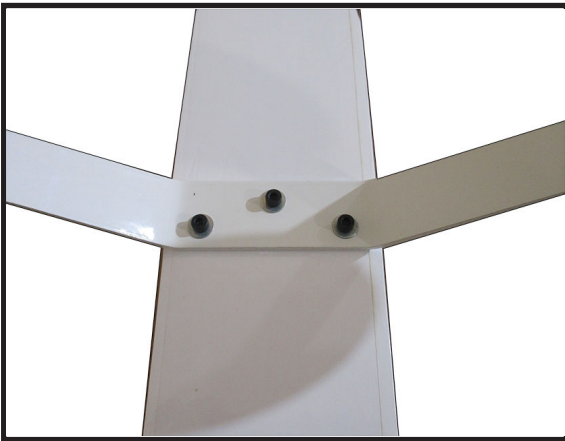

**ENGINE MOUNT INSTALLATION.**

1) Locate the items necessary to install the engine mount included with your model. .

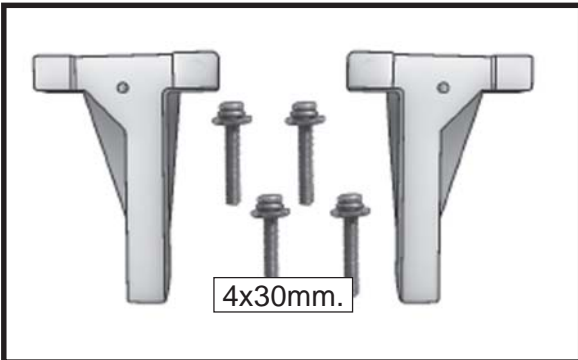

2) Use four 4x30mm head bolts and four 4mm washers to attach the engine mount rails to the firewall. Tighten the screws . Make sure to use threadlock on the screws to help prevent them from vibrating loose.

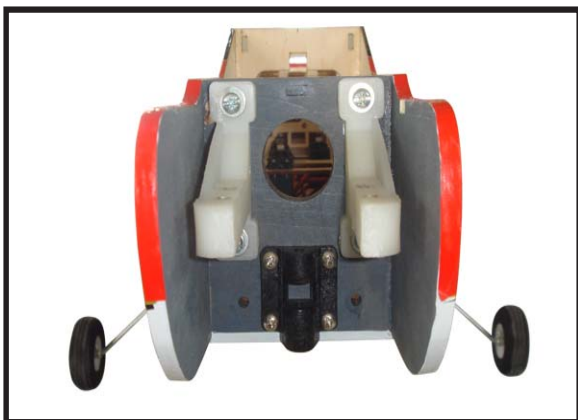

**FUEL TANK.**

**INSTALLING THE STOPPER ASSEMBLY.**

1. Using a modeling knife, carefully cut off the rear portion of **one** of the two nylon tubes leaving 1/2" protruding from the rear of the stopper. This will be the fuel pick up tube.

2. Using a modeling knife, cut one length of silicon fuel line (not included) to 2-1/4" long. Connect one end of the line to the weighted fuel pickup and the other end to the nylon pickup tube.

3. Carefully bend the second nylon tube up at a 45° angle. This tube is the vent tube.

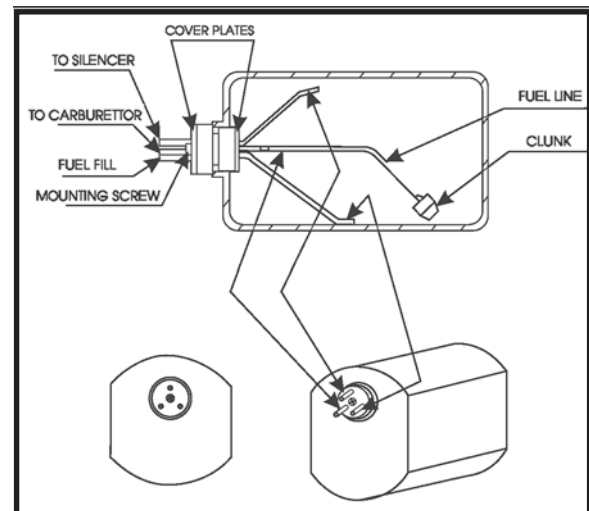
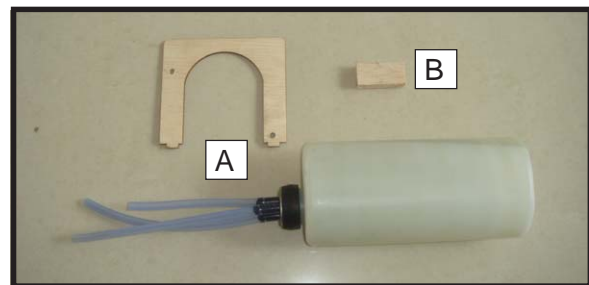

4. Carefully heat the vent tube using a heat gun or lighter to permanently set the angle of the tube.

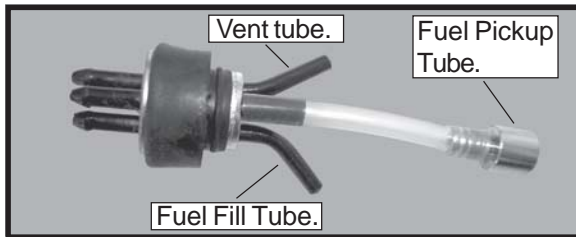

When the stopper assembly is installed in the tank, the top of the vent tube should rest just below the top surface of the tank. It should not touch the top of the tank.

5. Test fit the stopper assembly into the tank. It may be necessary to remove some of the flashing around the tank opening using a modeling knife. If flashing is present, make sure none falls into the tank.

6. With the stopper assembly in place, the weighted pickup should rest about 3/8" away from the rear of the tank and move freely inside the tank. The top of the vent tube should rest just below the top of the tank. It should not touch the top of the tank.

7. When satisfied with the alignment of the stopper assembly tighten the 3mm x 20mm machine screw until the rubber stopper expands and seals the tank opening. Do not overtighten the assembly as this could cause the tank to split.

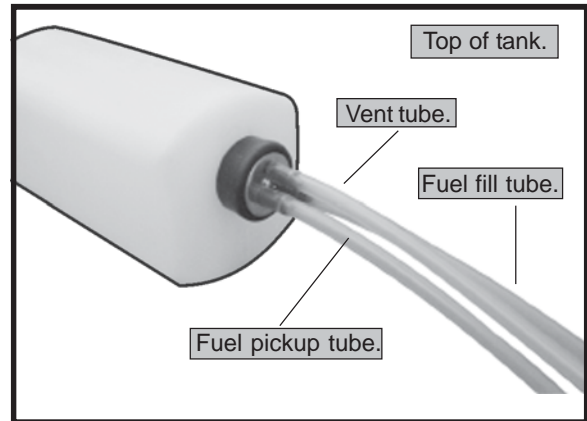
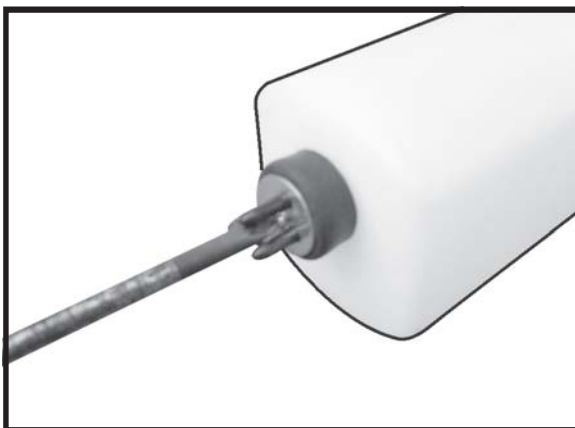

### INSTALLING THE FUEL TANK.

**!** *You should mark which tube is the vent and which is the fuel pickup when you attach fuel tubing to the tubes in the stopper. Once the tank is installed inside the fuselage, it may be difficult to determine which is which.*

1) Slide the fuel tank into the fuselage. Guide the lines from the tank through the hole in the firewall.

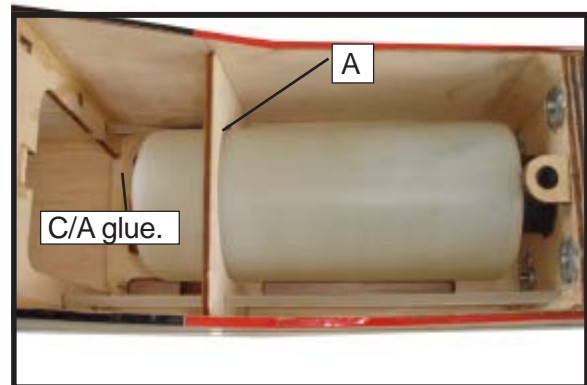

2) Use balsa plywood to help prevent moveable from transferring to the fuel tank as shown.

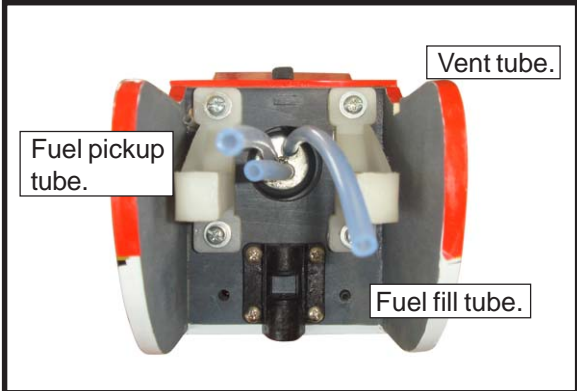
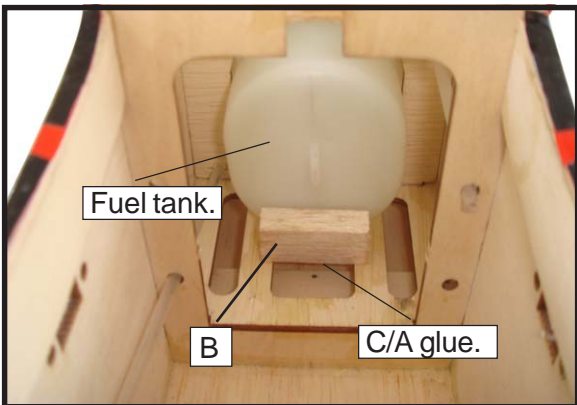

**INSTALLING THE FUSELAGE SERVOS.**

**!** *Because the size of servos differ, you may need to adjust the size of the pre-cut opening in the mount. The notch in the sides of the mount allow the servo lead to pass through.*

- 1) Install the rubber grommets and brass collets onto the throttle servo. Test fit the servo into the aileron servo mount.
- 2) Secure the servos with the screws provided with your radio system.

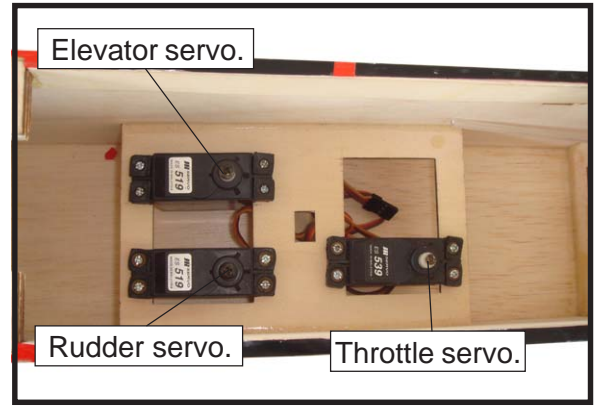

**THROTTLE SERVO ARM INSTALLATION.**

Install adjustable servo connector in the servo arm as same as picture below:

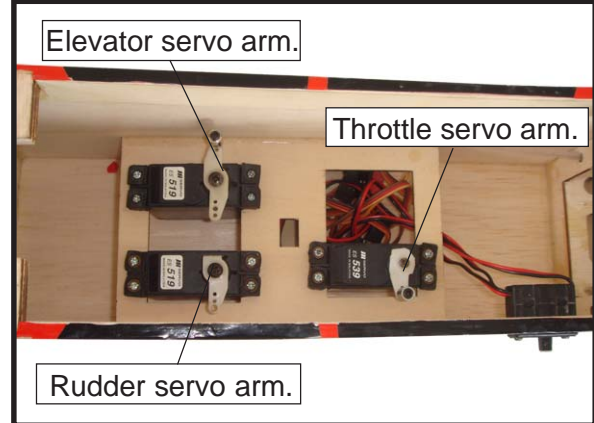
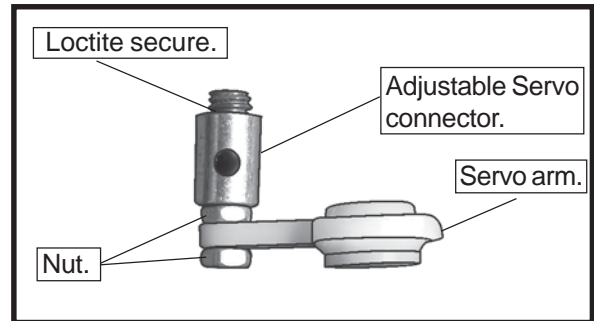

**INSTALLING THE SWITCH.**

Install the switch into the pre-cut hole in the side, in the fuselage.

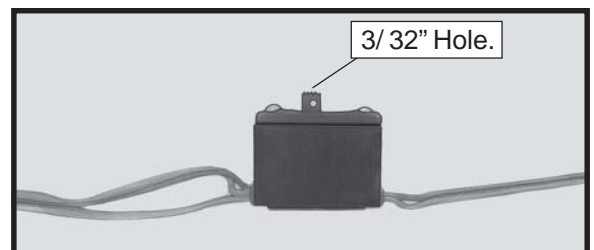



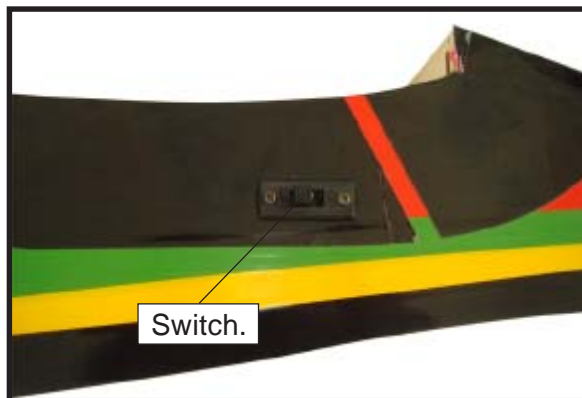
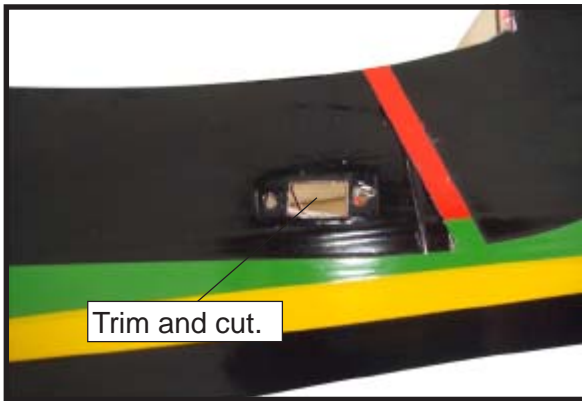

## MOUNTING THE ENGINE.

### PARTS REQUIRED.

1. Install the pushrod housing through the predrilled hole in the firewall and into the servo compartment. The pushrod housing should protrude 1/4" out past the front of the firewall. Make a Z-Bend 1/4" from one end of the plain wire pushrod.

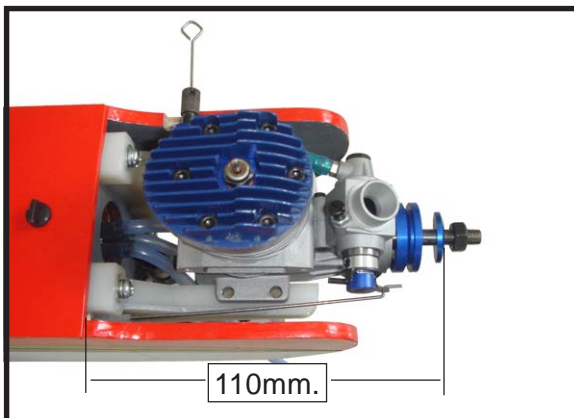

2. Place your engine onto the engine mount. Adjust the engine is centered of the edges of the engine case.

3. When you are satisfied with the alignment, mark the locations of the engine mounting.



4. Remove the engine. Using a drill bit, drill the mounting holes through the engine mount at the four locations marked.

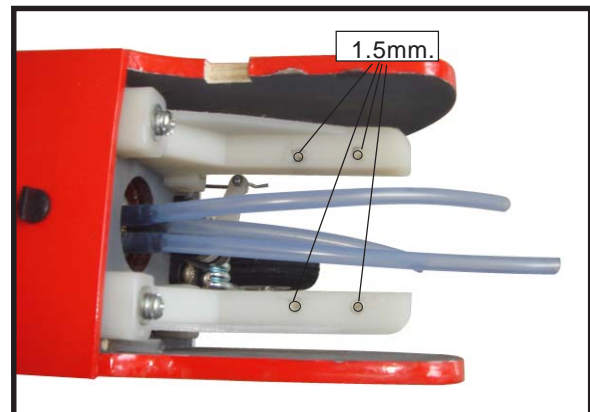
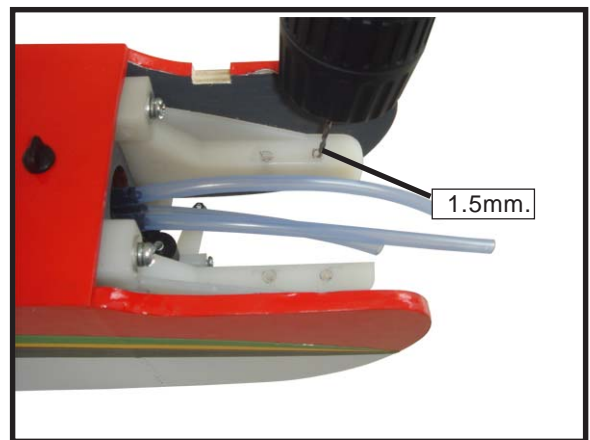

5. Bolt the engine to the engine mount using the four machine screws. Double check that all the screws are tight before proceeding.

6. Attach the Z-Bend in the pushrod wire to the throttle arm on the carburetor. You will need to remove the throttle arm from the carburetor to be able to attach the Z-bend. When complete, reattach the throttle arm to the carburetor.

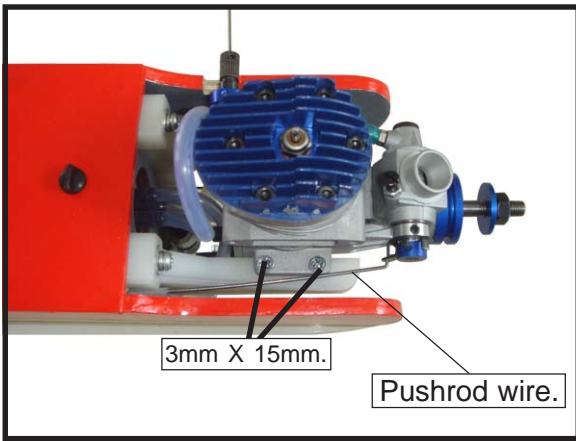

Installing steering arm as follow.



Adjust the nose gear steering arm until the arm is parallel with the fire wall.

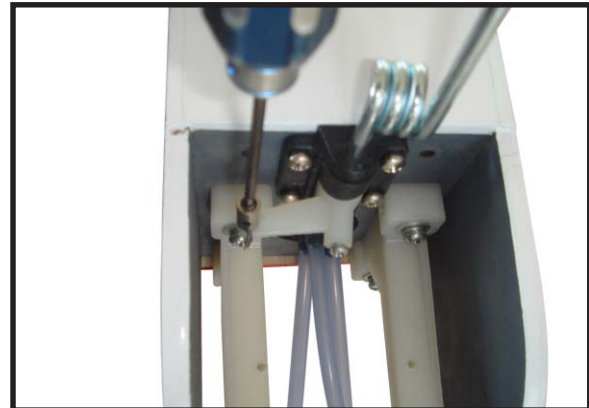

**NOSE GEAR INSTALLATION.**



**TOOLS REQUIRED**

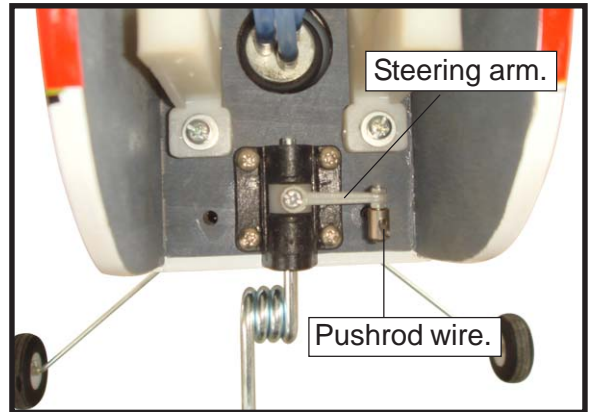
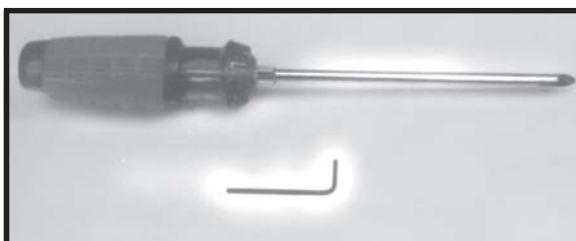

**ELECTRIC POWER CONVERSION.**

1) Locate the items necessary to install the electric power conversion included with your model.

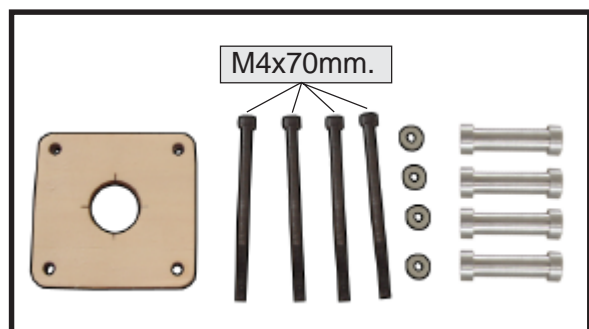

- **Model size: .40-.46 size models**
- **Motor: 46 (925 watt)**
- **Propeller: 12x8 - 14x10**
- **ESC: 60A**
- **Lipo Batteries: 4S - 5S**

2) Attach the electric motor box to the firewall suitable with the cross lines drawn on the electric motor box and firewall. Using epoxy and balsa stick to secure the motor box to the firewall. Please see pictures below.

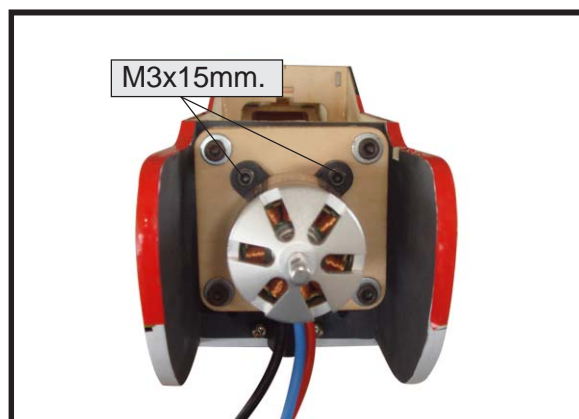
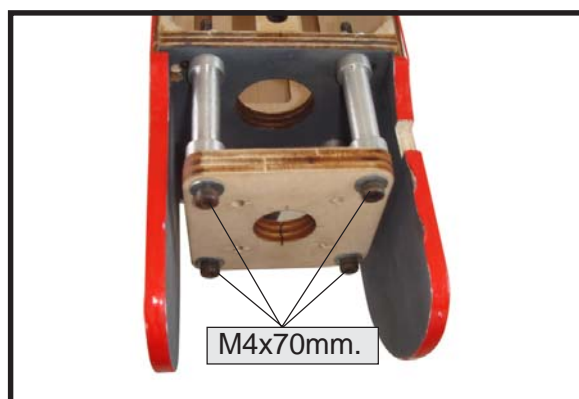
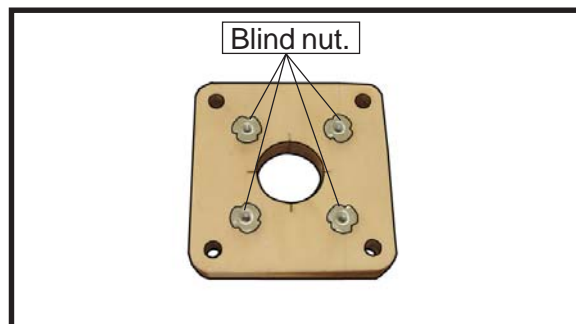
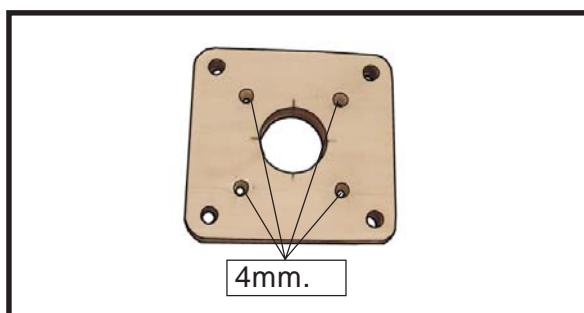
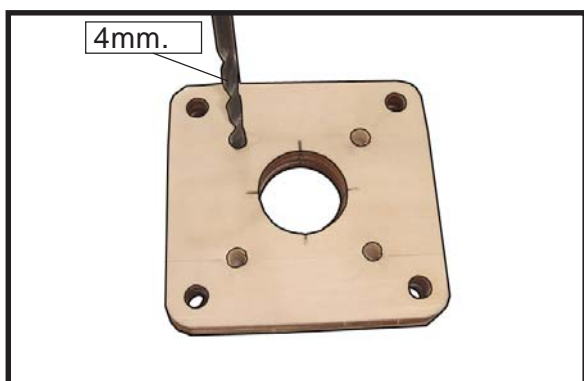
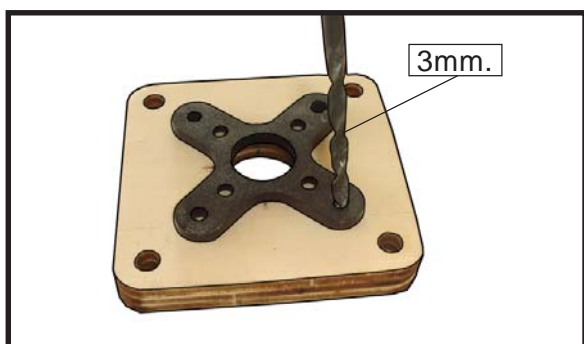
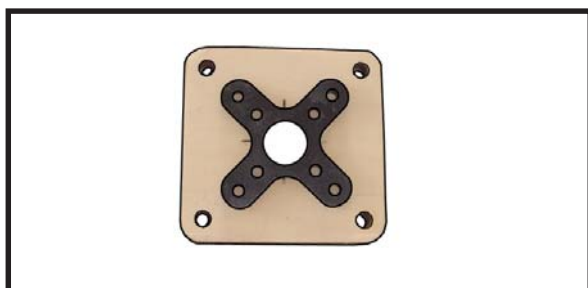



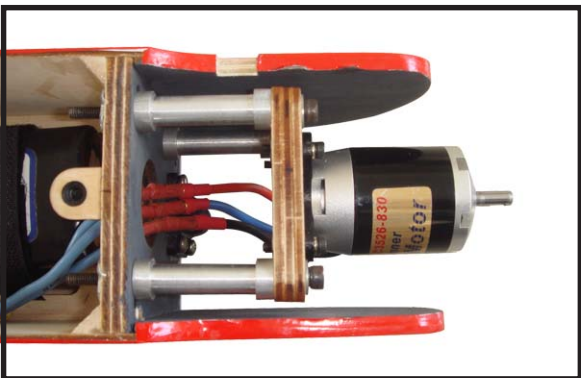
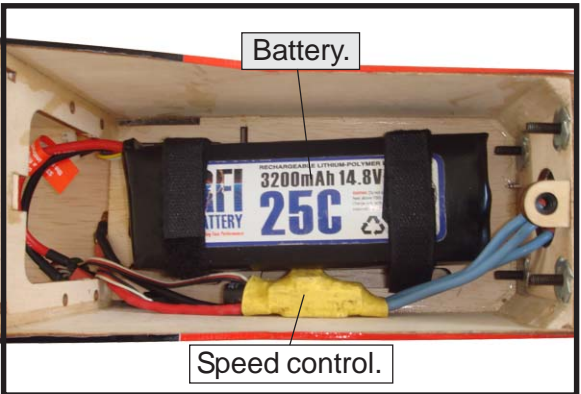
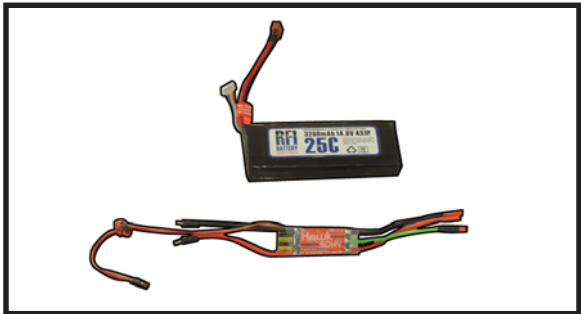
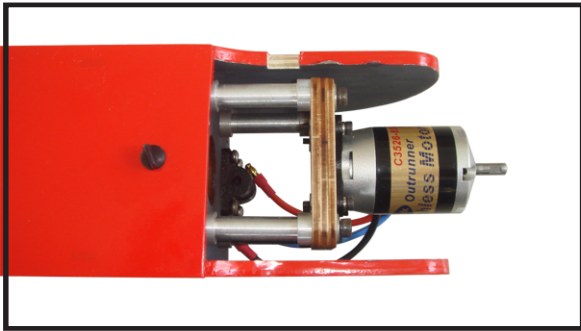

**INSTALLING THE SPINNER.**

Install the spinner backplate, propeller and spinner cone. The spinner cone is held in place using two 3mm x 12mm wood screws.

**!** *The propeller should not touch any part of the spinner cone. If it does, use a sharp modeling knife and carefully trim away the spinner cone where the propeller comes in contact with it.*

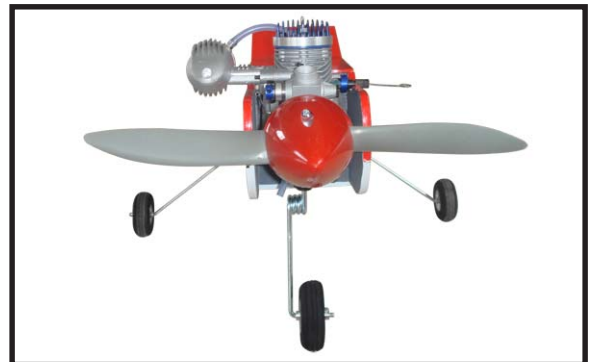

**HORIZONTAL STABILIZER.**

1. Using a ruler and a pen, locate the centerline of the horizontal stabilizer, at the trailing edge, and place a mark. Use a triangle and extend this mark, from back to front, across the top of the stabilizer. Also extend this mark down the back of the trailing edge of the stabilizer.

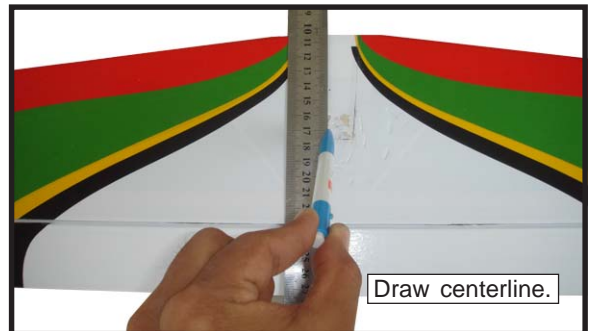

**!** *The top of the stabilizer does **not** have the hinge pins exposed.*

2. Using a modeling knife, carefully remove the covering from over the vertical stabilizer mounting slot in the top of the fuselage.

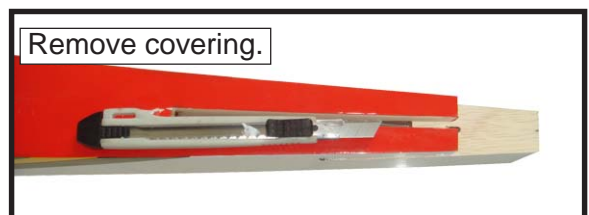



3. Slide the stabilizer into place in the pre-cut slot in the rear of the fuselage. The stabilizer should be pushed firmly against the front of the slot.

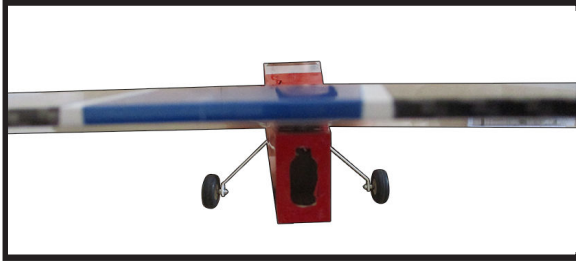

4. With the stabilizer held firmly in place, use a pen and draw lines onto the stabilizer where it and the fuselage sides meet. Do this on both the right and left sides and top and bottom of the stabilizer.

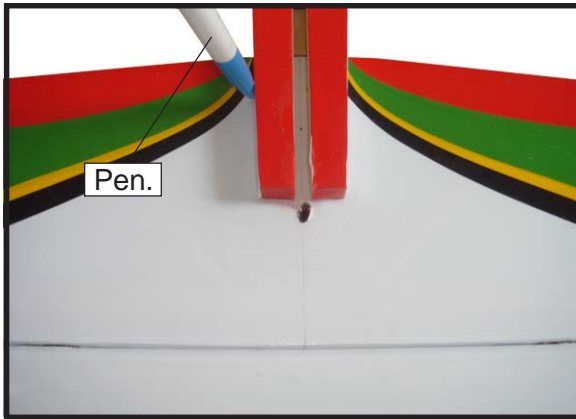

5. Remove the stabilizer. Using the lines you just drew as a guide, carefully remove the covering from between them using a modeling knife.

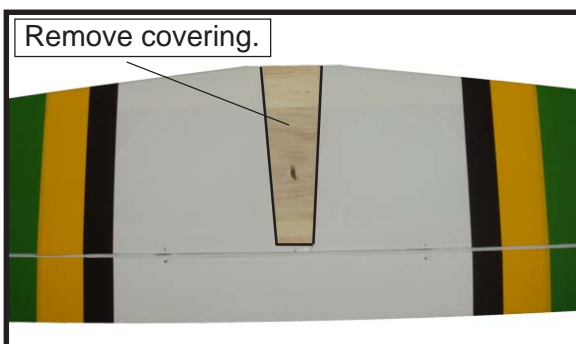

*When cutting through the covering to remove it, cut with only enough pressure to only cut through the covering itself. Cutting into the balsa structure may weaken it.*

6. Using a modeling knife, carefully remove the covering that overlaps the stabilizer mounting platform sides in the fuselage. Remove the covering from both the top and the bottom of the platform sides.

7. When you are sure that everything is aligned correctly, mix up a generous amount of 30 Minute Epoxy. Apply a thin layer to the top and bottom of the stabilizer mounting area and to the stabilizer mounting platform sides in the fuselage. Slide the stabilizer in place and realign. Double check all of your measurements once more before the epoxy cures. Hold the stabilizer in place with T-pins or masking tape and remove any excess epoxy using a paper towel and rubbing alcohol.



8. After the epoxy has fully cured, remove the masking tape or T-pins used to hold the stabilizer in place. Carefully inspect the glue joints. Use more epoxy to fill in any gaps that may exist that were not filled previously and clean up the excess using a paper towel and rubbing alcohol.

## VERTICAL STABILIZER INSTALLATION.



1. Slide the vertical stabilizer into the slot in the top of the fuselage. The bottom edge of the stabilizer should also be firmly pushed against the top of the horizontal stabilizer.



2. While holding the vertical stabilizer firmly in place, use a pen and draw a line on each side of the vertical stabilizer where it meets the top of the fuselage.

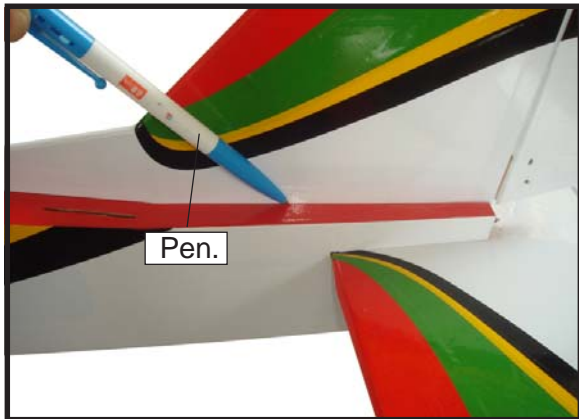

3. Remove the stabilizer. Using a modeling knife, remove the covering from below the lines you drew. Also remove the covering from the bottom edge of the stabilizer and the bottom and top edges of the filler block. Leave the covering in place on the sides of the filler block.



**!** When cutting through the covering to remove it, cut with only enough pressure to only cut through the covering itself. Cutting into the balsa structure may weaken it.

4. Slide the vertical stabilizer back in place. Using a triangle, check to ensure that the vertical stabilizer is aligned 90° to the horizontal stabilizer.

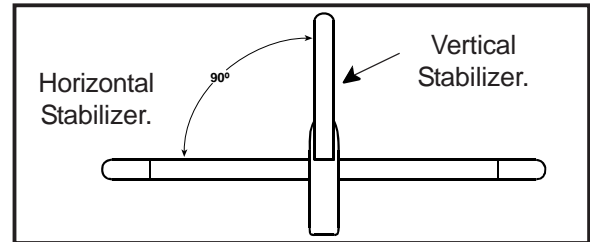

5. When you are sure that everything is aligned correctly, mix up a generous amount of Flash 30 Minute Epoxy. Apply a thin layer to the mounting slot in the top of the fuselage and to the sides and bottom of the vertical stabilizer mounting area. Apply epoxy to the bottom and top edges of the filler block and to the lower hinge also. Set the stabilizer in place and realign. Double check all of your measurements once more before the epoxy cures. Hold the stabilizer in place with T-pins or masking tape and remove any excess epoxy using a paper towel and rubbing alcohol. Allow the epoxy to fully cure before proceeding.



**CONTROL HORN INSTALLATION.**

1. Locate the two nylon control horns, two nylon control horn backplates and four M2 x 15mm machine screws.

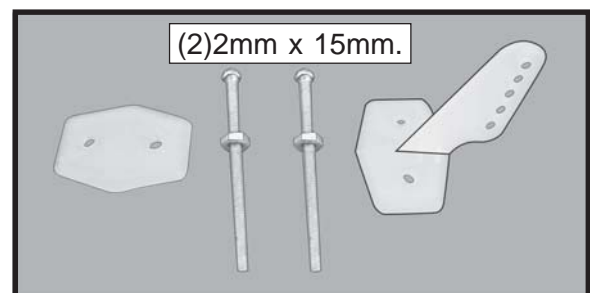

2. Position the elevator horn on the bottom side of elevator. The clevis attachment holes should be positioned over the hinge line.

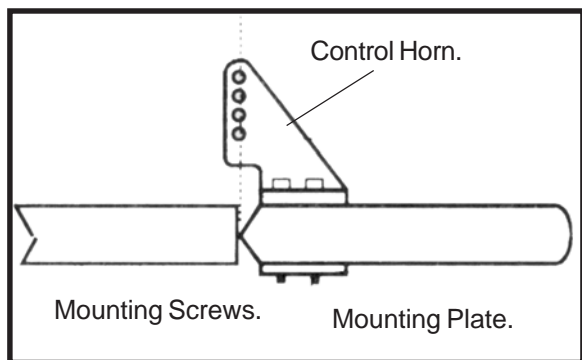

3. Using a 1.5mm drill bit and the control horns as a guide, drill the mounting holes through the elevator halves.



4. Install the rudder control horn using the same method as with the elevator control horns.



**ELEVATOR PUSHROD HORN INSTALLATION.**

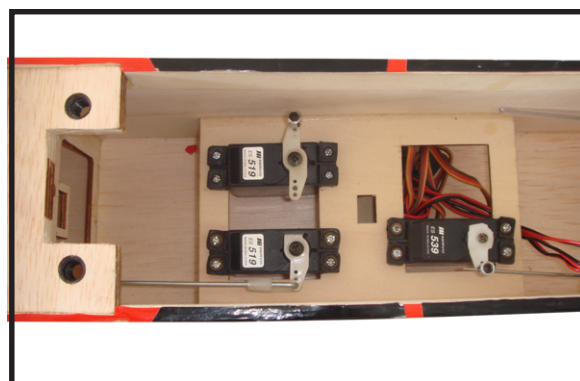
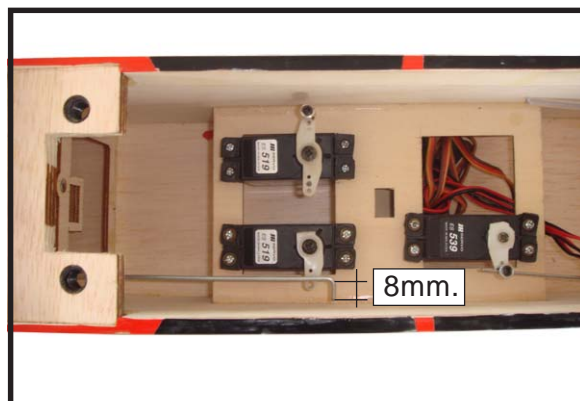
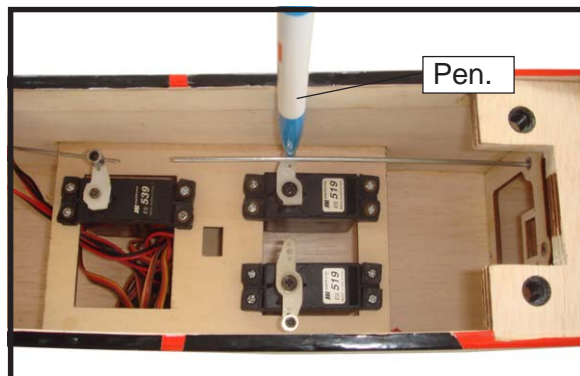
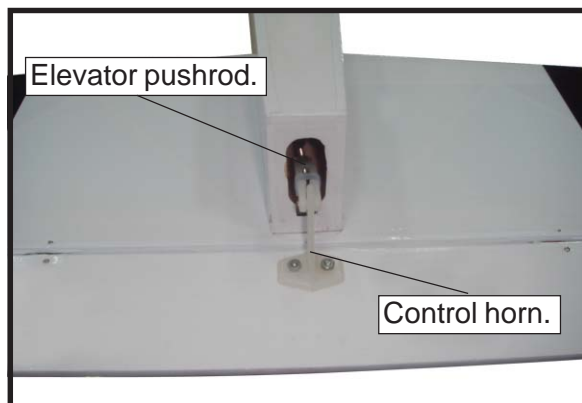

**RUDDER PUSHROD HORN INSTALLATION.**

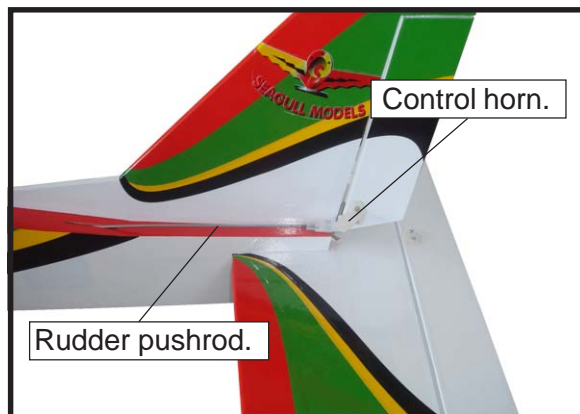



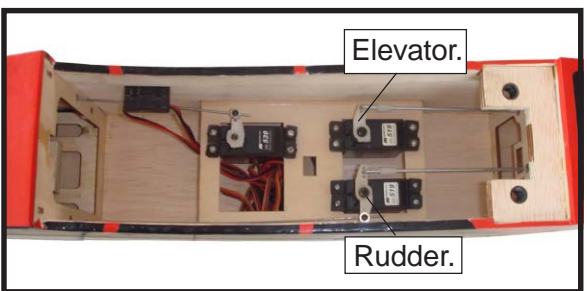
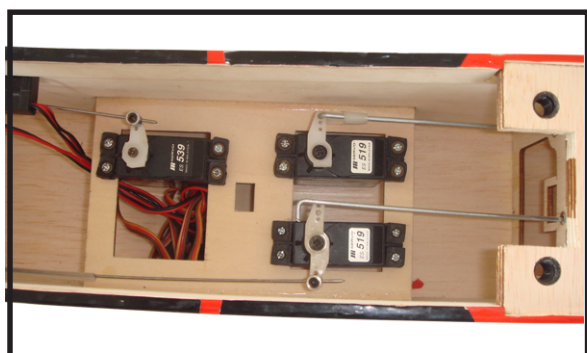
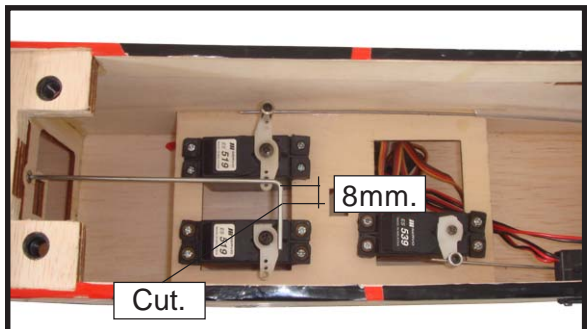
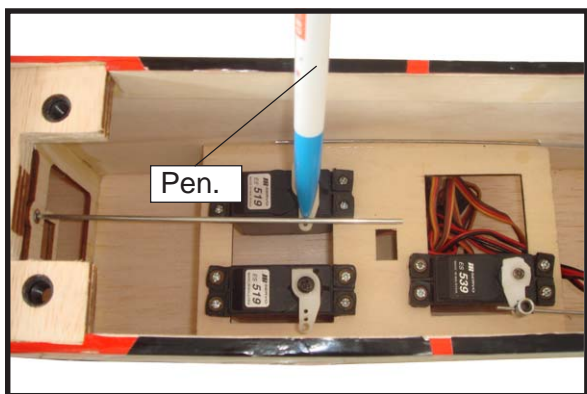

**INSTALLING THE RECEIVER AND BATTERY.**

- 1) Plug the five servo leads and the switch lead into the receiver. Plug the battery pack lead into the switch also.
- 2) Wrap the receiver and battery pack in the protective foam rubber to protect them from vibration.
- 3) Route the antenna in the antenna tube inside the fuselage and secure it to the bottom of fuselage using a plastic tape.

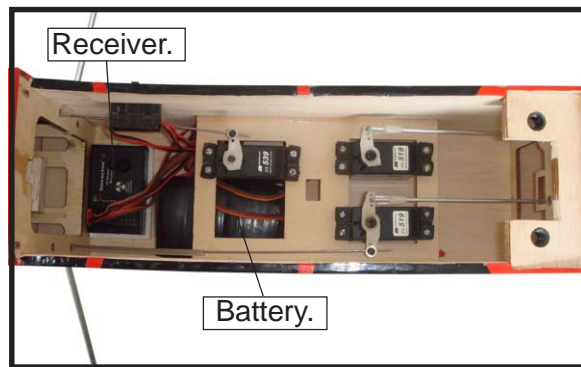

**ATTACHMENT WING-FUSELAGE.**

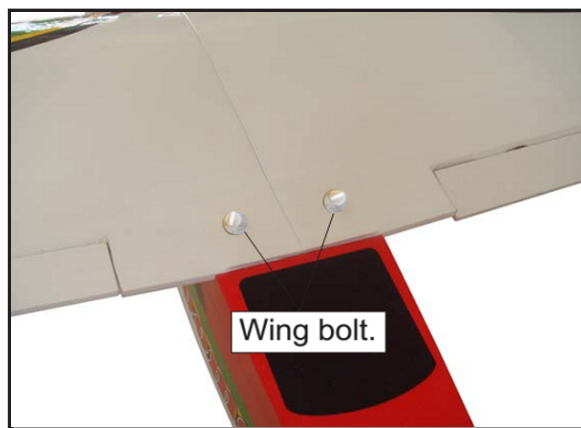
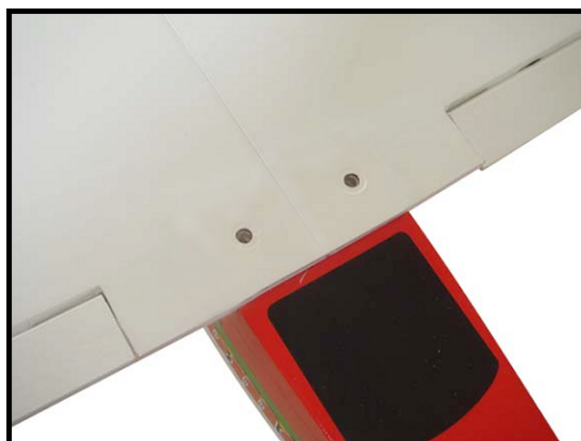

**TAIL - DRAGGER CONVERSION.**

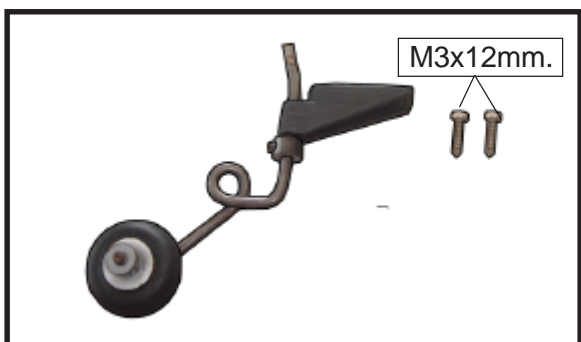



- 1) Test fit the fin and the tail gear, to make sure that everything fits properly. When you are happy with the fit, glue the fin permanently in place.
- 2) See below picture how to assembly the tail-Dragger Conversion.

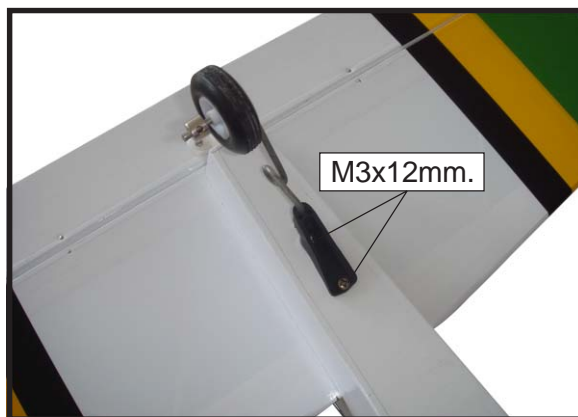

- 3) Install the control horn on the rudder, then hold the rudder in place and mark it where the music wire will enter. When you are happy with the fit, fill the hole with epoxy and use CA to glue in the rudder hinges.

#### INSTALLING THE MAIN GEAR WIRES.

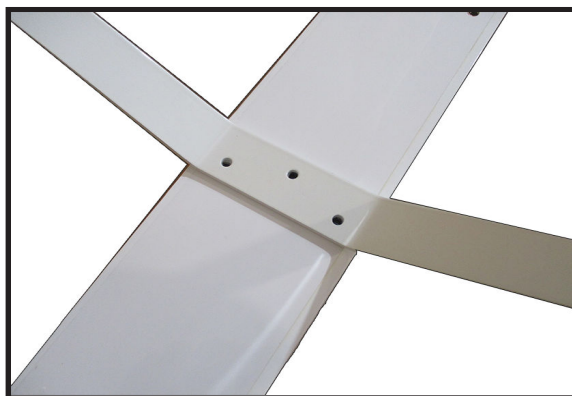

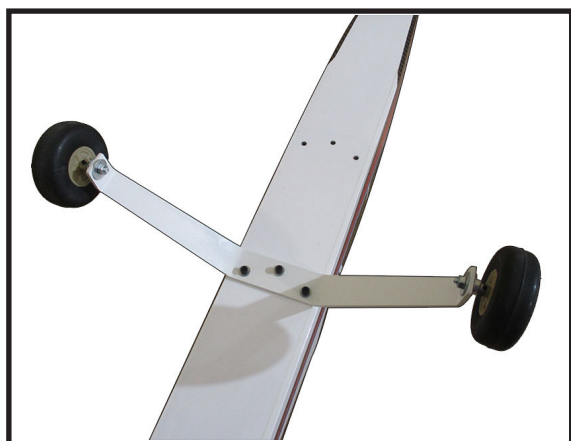
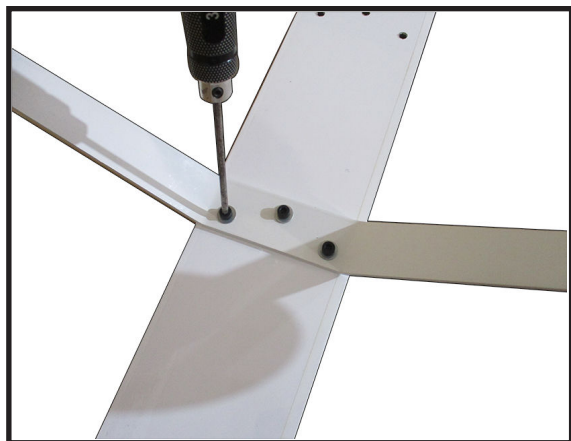

### BALANCING.

❑ 1) It is critical that your airplane be balanced correctly. Improper balance will cause your plane to lose control and crash. THE CENTER OF GRAVITY IS LOCATED **75 MM** BACK FROM THE LEADING EDGE OF THE WING AT THE WING ROOT.

❑ 2) Mount the wing to the fuselage. Using a couple of pieces of masking tape, place them on the top side of the wing **75 mm** back from the leading edge of the wing at the wing root.

❑ 3) Turn the airplane upside down. Place your fingers on the masking tape and carefully lift the plane .

Accurately mark the balance point on the top of the wing on both sides of the fuselage. The balance point is located **75 mm** back from the leading edge of the wing at the wing root. This is the balance point at which your model should balance for your first flights. Later, you may wish to experiment by shifting the balance up to 10mm forward or back to change the flying characteristics. Moving the balance forward may improve the smoothness and arrow- like tracking, but it may then require more speed for take off and make it more difficult to slow down for landing. Moving the balance aft makes the model more agile with a lighter and snappier "feel". In any case, please start at the location we recommend .

With the wing attached to the fuselage, all parts of the model installed ( ready to fly), and empty fuel tanks, hold the model at the marked balance point with the stabilizer level.

Lift the model. If the tail drops when you lift, the model is "tail heavy" and you must add weight\* to the nose. If the nose drops, it is "nose heavy" and you must add weight\* to the tail to balance.

\*If possible, first attempt to balance the model by changing the position of the receiver battery and receiver. If you are unable to obtain good balance by doing so, then it will be necessary to add weight to the nose or tail to achieve the proper balance point.

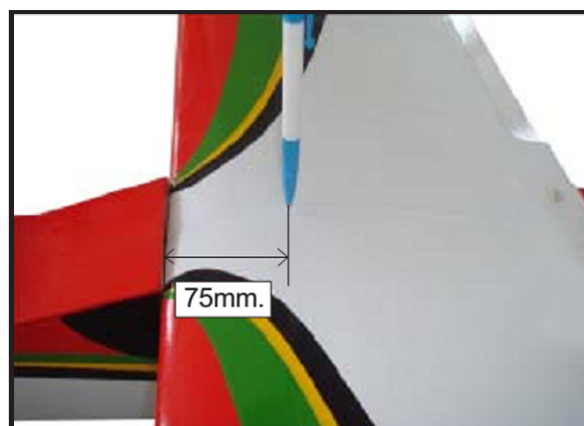

## CONTROL THROWS.

1. We highly recommend setting up the **Boomerang 40** using the control throws listed at right. We have listed control throws for both initial test flying/sport flying and aerobatic flying.

2. Turn on the radio system, and with the trim tabs on the transmitter in neutral, center the control surfaces by making adjustments to the clevises or adjustable servo connectors. The servo arms should be centered also.

3. When the elevator, rudder and aileron control surfaces are centered, use a ruler and check the amount of the control throw in each surface. **The control throws should be measured at the widest point of each surface!**

### INITIAL FLYING/SPORT FLYING

Ailerons:	3/8" up	3/8" down
Elevator:	3/8" up	3/8" down
Rudder:	1/2" right	1/2" left

### AEROBATIC FLYING

Ailerons:	1/2" up	1/2" down
Elevator:	5/8" up	5/8" down
Rudder:	1" right	1" left

*Do not use the aerobatic settings for initial test flying or sport flying.*

4. By moving the position of the adjustable control horn out from the control surface, you will decrease the amount of throw of that control surface. Moving the adjustable control horn toward the control surface will increase the amount of throw.

**FLIGHT PREPARATION.**

A) Check the operation and direction of the elevator, rudder, ailerons and throttle.

B) Plug in your radio system per the manufacture's instructions and turn every thing on.

C) Check the elevator first. Pull back on the elevator stick. The elevator halves should move up. If it they do not, flip the servo reversing switch on your transmitter to change the direction.

D) Check the rudder. Looking from behind the airplane, move the rudder stick to the right. The rudder should move to the right. If it does not, flip the servo reversing switch on your transmitter to change the direction.

E) Check the throttle. Moving the throttle stick forward should open the carburetor barrel. If it does not, flip the servo reversing switch on your transmitter to change the direction.

F) From behind the airplane, look at the aileron on the right wing half. Move the aileron stick to the right. The right aileron should move up and the other aileron should move down. If it does not, flip the servo reversing switch on your transmitter to change the direction.

**PREFLIGHT CHECK.**

1) Completely charge your transmitter and receiver batteries before your first day of flying.

2) Check every bolt and every glue joint in the **Boomerang 40** to ensure that everything is tight and well bonded.

3) Double check the balance of the airplane. Do this with the fuel tank empty.

4) Check the control surfaces. All should move in the correct direction and not bind in any way.

5) If your radio transmitter is equipped with dual rate switches double check that they are on the low rate setting for your first few flights.

6) Check to ensure the control surfaces are moving the proper amount for both low and high rate settings.

7) Check the receiver antenna. It should be fully extended and not coiled up inside the fuselage.

8) Properly balance the propeller. An out of balance propeller will cause excessive vibration which could lead to engine and/or airframe failure.

***We wish you many safe and enjoyable flights with your BOOMERANG 40.***