









# Expedition Rack Assembly

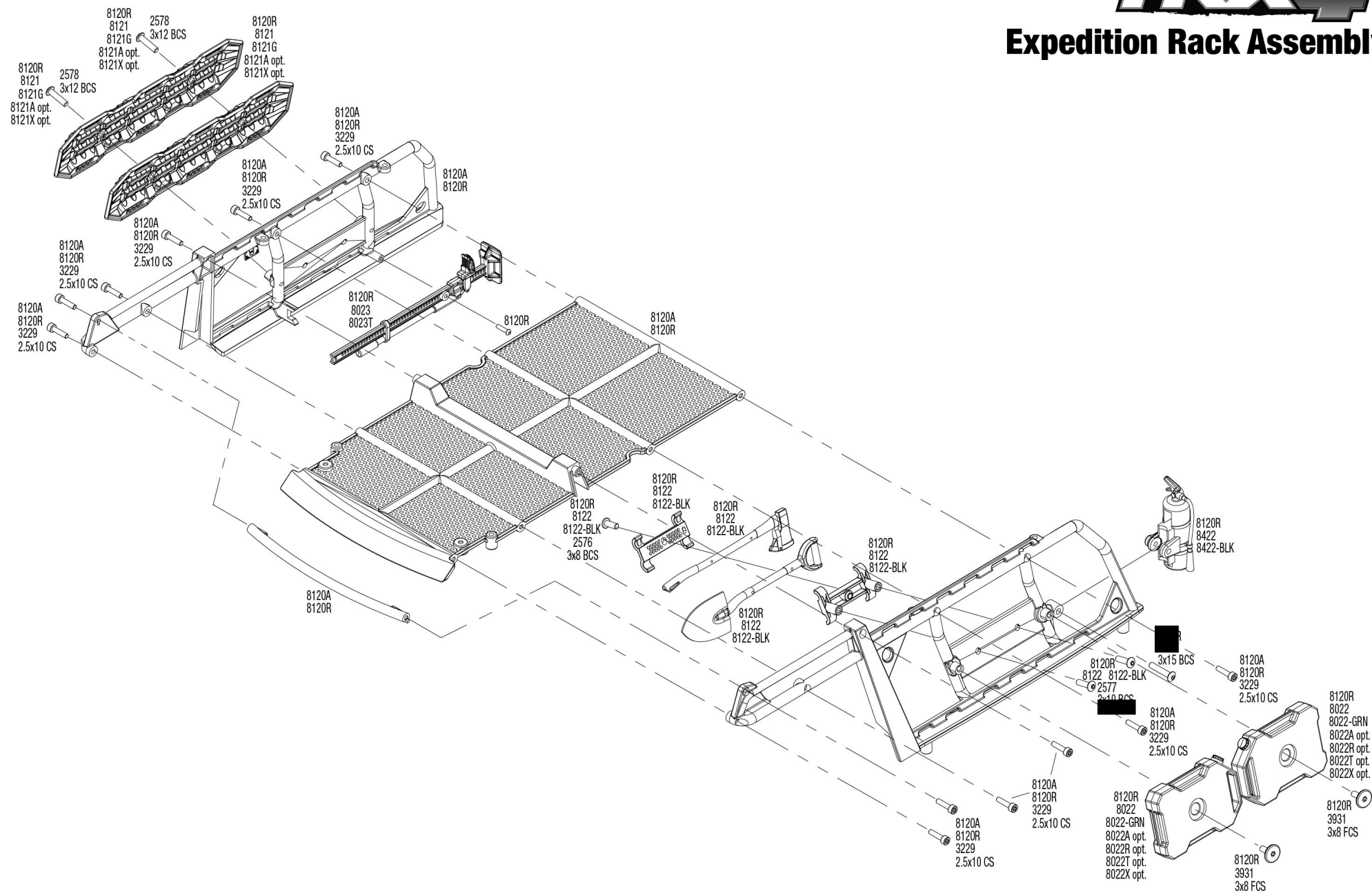

See Parts List for a complete listing of optional accessories.

Specifications on this page are subject to change without notice. Every attempt has been made to ensure the accuracy of this drawing; however, Traxxas cannot be held responsible for typographical or other errors.

# TRX4<sup>®</sup>

## Front Assembly

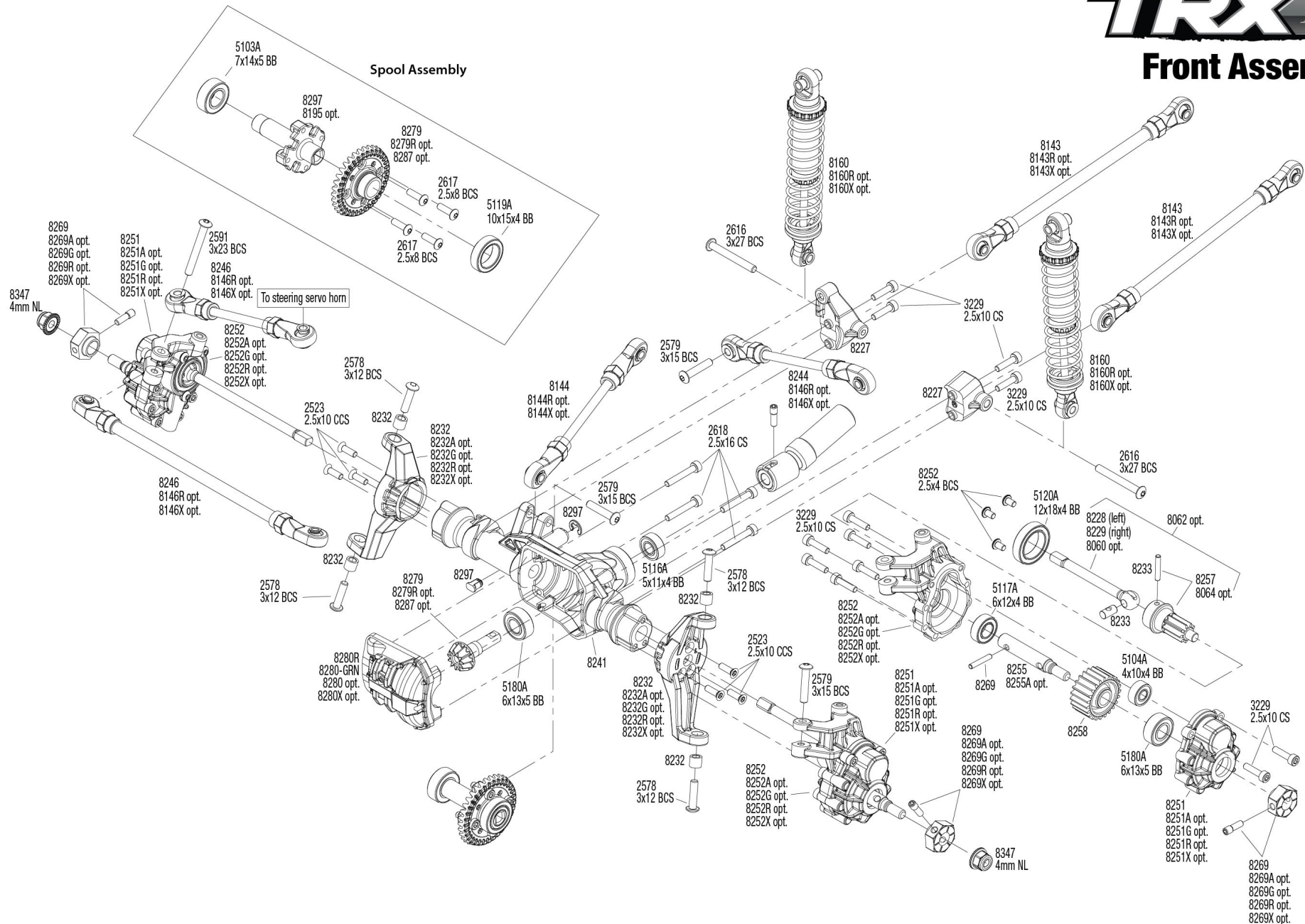

See Parts List for a complete listing of optional accessories.

Specifications on this page are subject to change without notice. Every attempt has been made to ensure the accuracy of this drawing; however, Traxxas cannot be held responsible for typographical or other errors.

REV 240125-R05





# Link Dimensions

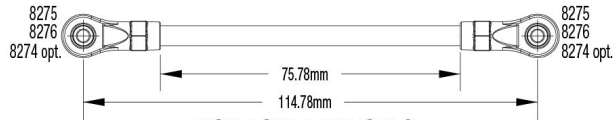

**FRONT LOWER LINK (QTY. 2)**

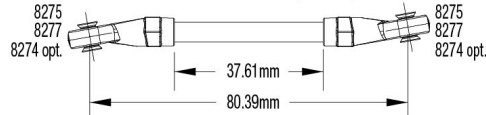

**FRONT UPPER LINK (QTY. 1)**

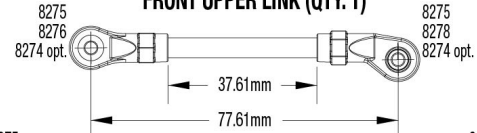

**PANHARD BAR (QTY. 1)**

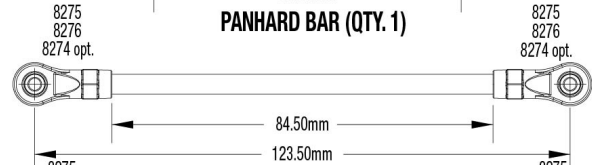

**REAR LOWER LINK (QTY. 2)**

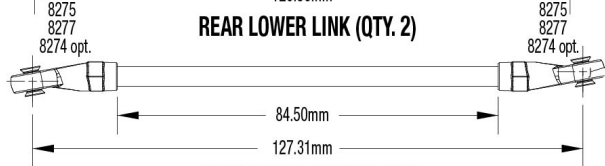

**REAR UPPER LINK (QTY. 2)**

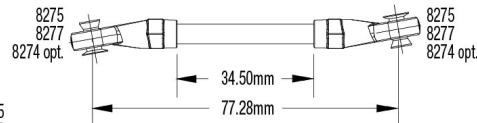

**STEERING LINK (QTY. 1)**

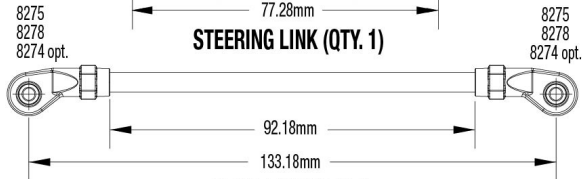

**DRAG LINK (QTY. 1)**

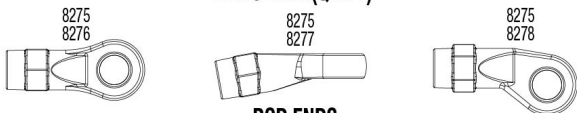

**ROD ENDS**

For standard hollow ball replacement, use part #5349.

# Modular Assembly

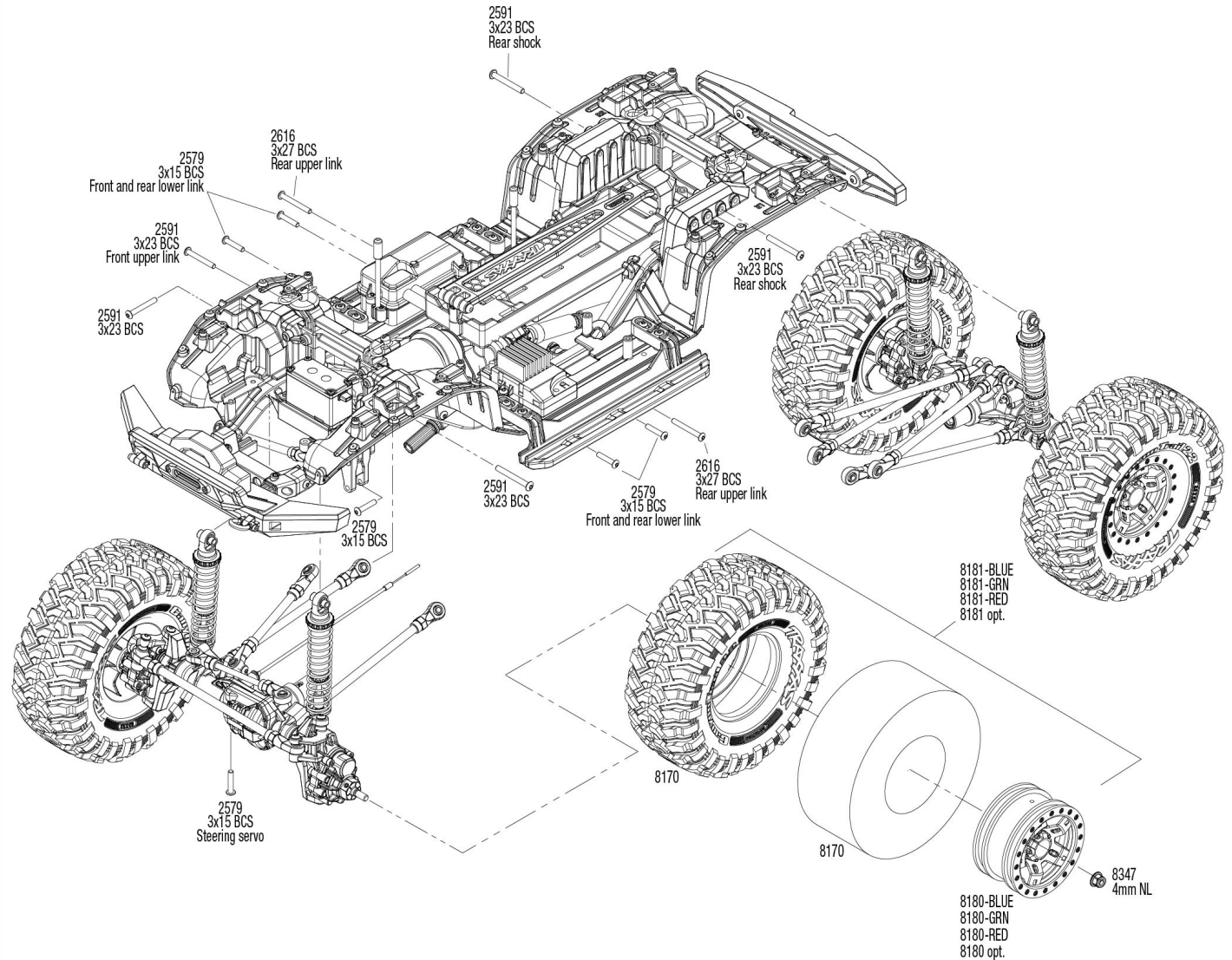

See Parts List for a complete listing of optional accessories.

Specifications on this page are subject to change without notice. Every attempt has been made to ensure the accuracy of this drawing; however, Traxxas cannot be held responsible for typographical or other errors.



### Shock Assembly

