

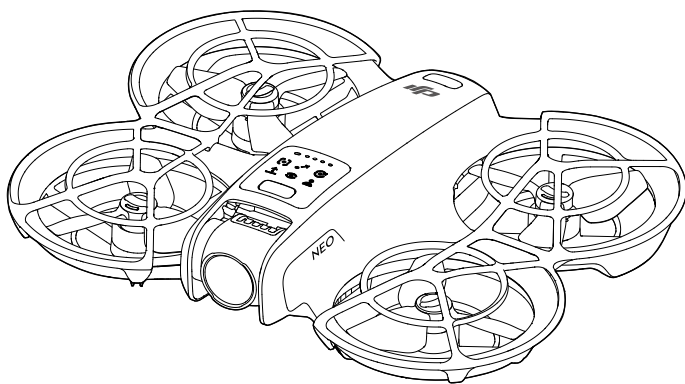

User Manual

v1.0 2024.09





This document is copyrighted by DJI with all rights reserved. Unless otherwise authorized by DJI, you are not eligible to use or allow others to use the document or any part of the document by reproducing, transferring or selling the document. Only refer to this document and the content thereof as instructions to operate DJI UAVs. The document should not be used for other purposes.

Searching for Keywords

Search for keywords such as “battery” and “install” to find a topic. If you are using Adobe Acrobat Reader to read this document, press Ctrl+F on Windows or Command+F on Mac to begin a search.

Navigating to a Topic

View a complete list of topics in the table of contents. Click on a topic to navigate to that section.

Printing this Document

This document supports high resolution printing.

Using this Manual

Legend

△ Important

💡 Hints and Tips

📖 Reference

Read Before First Flight

DJI™ provides you with tutorial videos and the following documents:

1. *Safety Guidelines*
2. *Quick Start Guide*
3. *User Manual*

It is recommended to watch all the tutorial videos and read the *Safety Guidelines* before using for the first time. Prepare for your first flight by reviewing the *Quick Start Guide* and refer to this *User Manual* for more information.

Video Tutorials

Go to the address below or scan the QR code to watch the tutorial videos, which demonstrate how to use the product safely.



<https://www.dji.com/neo/video>

Downloading the DJI Fly App

Make sure to use DJI Fly with this product. Scan the QR code to download the latest version.



- ⚠ • To check the Android and iOS operating system versions supported by DJI Fly, visit <https://www.dji.com/downloads/djiapp/dji-fly>.
 - The interface and functions of DJI Fly may vary as the software version is updated. Actual usage experience is based on the software version used.
-

- [1] For increased safety, flight is restricted to a height of 98.4 ft (30 m) and a range of 164 ft (50 m) when not connected or logged into the app during flight.
- [2] For Palm Control and Mobile App Control, takeoff is disabled when DJI Neo is not connected to the app for longer than 90 days or the smartphone with the app has no access to the internet during the period. To enable takeoff, reconnect DJI Neo to the app when the smartphone is connected to the internet.

Downloading DJI Assistant 2

Download DJI ASSISTANT™ 2 (Consumer Drones Series) at:

<https://www.dji.com/downloads/softwares/dji-assistant-2-consumer-drones-series>

- ⚠ • The operating temperature of this product is -10° to 40° C. It does not meet the standard operating temperature for military-grade application (-55° to 125° C), which is required to endure greater environmental variability. Operate the product appropriately and only for applications that meet the operating temperature range requirements of that grade.
-

Contents

Using this Manual	3
Legend	3
Read Before First Flight	3
Video Tutorials	3
Downloading the DJI Fly App	3
Downloading DJI Assistant 2	4
1 Product Profile	9
1.1 Introduction	9
1.2 Using for the First Time	9
Preparing DJI Neo	9
Preparing the Remote Controller	10
Activation	11
Firmware Update	12
1.3 Overview	12
DJI Neo	12
DJI RC-N3 Remote Controller	13
2 Flight Safety	15
2.1 Flight Restrictions	15
GEO (Geospatial Environment Online) System	15
Flight Limits	15
Flight Altitude and Distance Limits	15
GEO Zones	17
Unlocking GEO Zones	17
2.2 Flight Environment Requirements	17
2.3 Operating the Aircraft Responsibly	19
2.4 Pre-Flight Checklist	19
3 Flight Operation	22
3.1 Palm Control	22
Notice	22
Switching Modes	23
Palm Takeoff/Landing and Smart Snaps	26
3.2 Mobile App Control	28
Notice	28
Connecting DJI Neo	29
Smart Snaps	29
View Album	32
Manual Control	33

	Recording Audio via App	34
	Voice Control	34
3.3	RC Control	35
	Auto Takeoff	35
	Auto Landing	35
	Starting/Stopping the Motors	35
	Starting the Motors	35
	Stopping the Motors	35
	Stopping the Motors Mid-Flight	36
	Controlling the Aircraft	36
	Takeoff/Landing Procedures	38
	Intelligent Flight Modes	39
	FocusTrack	39
	QuickShots	42
	Cruise Control	43
3.4	Video Recording Suggestions and Tips	44
4	DJI Neo	47
4.1	Flight Modes	47
4.2	Status Indicator	48
4.3	Return to Home (RTH)	49
	Notice	50
	Trigger Method	51
	RTH Procedure	52
4.4	Auto Landing	52
	Trigger Method	52
	Landing Protection	53
4.5	Vision System and Infrared Sensing System	54
4.6	Propellers and Propeller Guards	56
	Removing and Installing	56
	Notice	59
4.7	Intelligent Flight Battery	60
	Notice	60
	Inserting and Removing the Battery	61
	Using the Battery	62
	Charging the Battery	64
	Using a Charger	64
	Using the Charging Hub	65
	Battery Protection Mechanisms	67
4.8	Gimbal and Camera	68
	Camera Notice	68
	Gimbal Notice	68

Gimbal Angle	69
Gimbal Operation Modes	69
4.9 Storing and Exporting Photos and Videos	69
Storing	69
Exporting	70
4.10 QuickTransfer	70
5 DJI RC-N3	72
5.1 Operations	72
Powering On/Off	72
Charging the Battery	72
Controlling the Gimbal and Camera	73
Flight Mode Switch	73
Flight Pause/RTH Button	73
Customizable Button	74
5.2 Battery Level LEDs	74
5.3 Remote Controller Alert	74
5.4 Optimal Transmission Zone	74
5.5 Linking the Remote Controller	75
6 Appendix	78
6.1 Specifications	78
6.2 Compatibility	78
6.3 Firmware Update	78
6.4 Flight Recorder	79
6.5 Post-Flight Checklist	79
6.6 Maintenance Instructions	79
6.7 Troubleshooting Procedures	80
6.8 Risks and Warnings	81
6.9 Disposal	81
6.10 C0 Certification	82
6.11 Aftersales Information	86

Product Profile

1 Product Profile

1.1 Introduction

DJI NEO™, equipped with a standard propeller guard, is light and portable. It provides stable hovering and smooth aerobatic maneuvers while flying both indoors and out. Palm takeoff/landing and multiple control methods are supported.

In Palm Control and Mobile App Control, you can perform multiple intelligent shooting modes by pressing the mode button on DJI Neo or by using the app.

DJI Neo is an FPV camera drone that can be used with the compatible goggles and remote control devices, providing an immersive flight experience.

-
- The included devices vary on the product combo purchased. This manual introduces the usage for multiple devices. Read the related contents according to your product.
 - Visit the official DJI website to check the goggles and remote control devices supported by DJI Neo. Refer to their corresponding user manuals for the usage.
-
-  Using the goggles does not satisfy the requirement of visual line of sight (VLOS). Some countries or regions require a visual observer to assist during flight. Make sure to comply with local laws and regulations when using the goggles.
-

1.2 Using for the First Time

Click the link below or scan the QR code to watch the tutorial video before first time use.



<https://www.dji.com/neo/video>

Preparing DJI Neo

1. Press down to remove the gimbal protector.

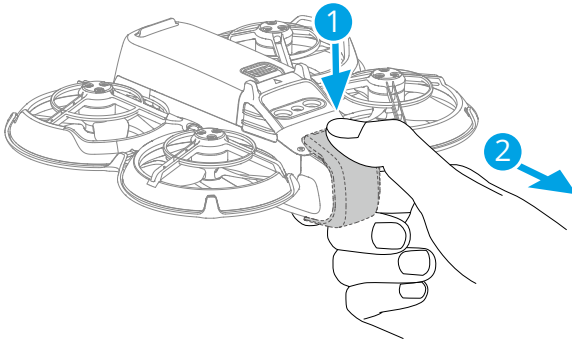

2. All Intelligent Flight Batteries are in hibernation mode before shipment to ensure safety. Activate the batteries by connecting a USB charger to the USB-C port on DJI Neo. The battery is activated when it begins charging.

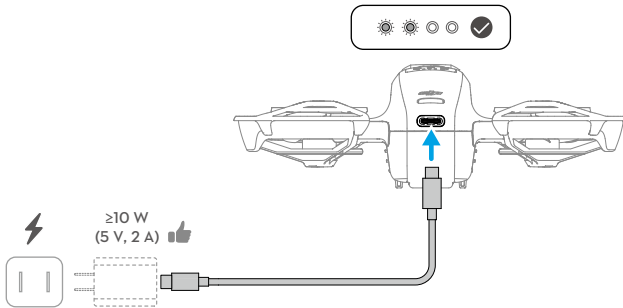

-
- It is recommended to attach the gimbal protector to protect the gimbal when DJI Neo is not in use.
-
- The maximum charging power supported for the USB-C port on DJI Neo is 15 W.
 - Make sure to remove the gimbal protector before powering on DJI Neo. Otherwise, it may affect the system performing self-diagnostics.
-

Preparing the Remote Controller

1. Remove the control sticks from the storage slots and mount them on the remote controller.
2. Pull out the mobile device holder. Choose the appropriate remote controller cable based on the port type of your mobile device (the cable with a USB-C connector is connected by default). Place your mobile device in the holder, then connect the end

of the cable without the remote controller logo to your mobile device. Make sure your mobile device is securely in place.

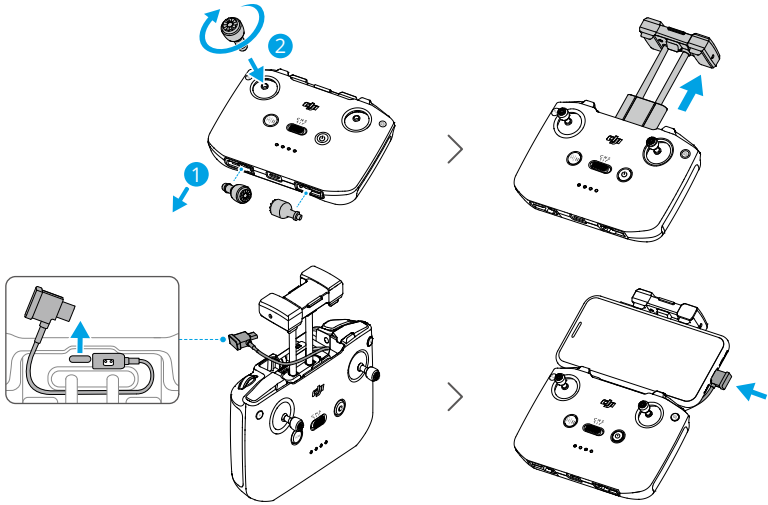

- ⚠ • If a USB connection prompt appears when an Android mobile device is used, select the option to charge only. Other options may cause the connection to fail.
- Adjust the mobile device holder to make sure your mobile device is firmly secure.

Activation

The product must be activated using the DJI Fly app before being used for the first time. An internet connection is required for activation. The activation method varies depending on the product combo purchased. Follow the corresponding instructions to activate your product.

DJI Neo

Press, then press and hold the power button to power on DJI Neo. Tap **Connection Guide** on the bottom right corner of the home screen in DJI Fly, select the device model, and then follow the on-screen instructions to complete connection and activation.

Fly More Combo

Press, then press and hold the power button to power on the aircraft and remote controller respectively. Make sure the smartphone is connected to the remote controller, and then follow the on-screen prompts to activate the aircraft using DJI Fly.

You can also follow the method for activating DJI Neo in the previous section to connect the aircraft to the app and activate the aircraft. Once completed, the aircraft can be used with the remote controller.

Firmware Update

A prompt will appear in DJI Fly when a firmware update is available. Update the firmware whenever prompted to ensure the optimal user experience.

1.3 Overview

DJI Neo

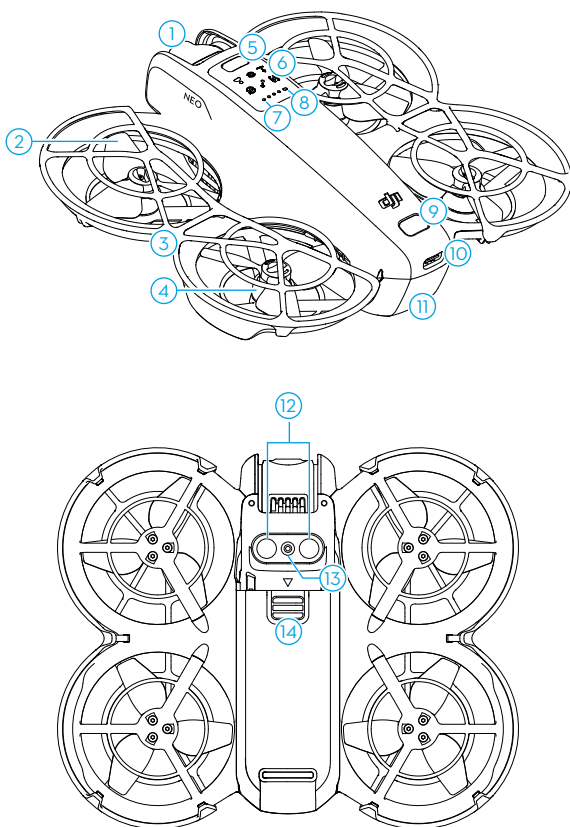

1. Gimbal and Camera
2. Propellers
3. Propeller Guard
4. Motors
5. Mode Button
6. Mode Indicators
7. Battery Level LEDs
8. Status Indicator
9. Power Button
10. USB-C Port
11. Intelligent Flight Battery
12. Infrared Sensing System
13. Downward Vision System
14. Battery Latch

DJI RC-N3 Remote Controller

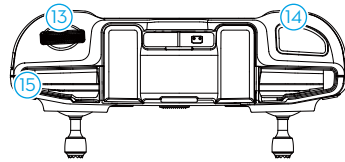
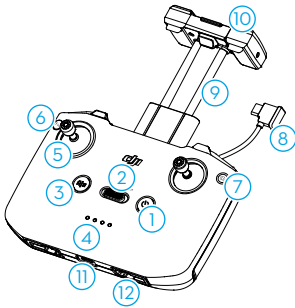

1. Power Button
2. Flight Mode Switch
3. Flight Pause/Return to Home (RTH) Button
4. Battery Level LEDs
5. Control Sticks
6. Customizable Button
7. Photo/Video Button
8. Remote Controller Cable
9. Mobile Device Holder
10. Antennas
11. USB-C Port
12. Control Stick Storage Slots
13. Gimbal Dial
14. Shutter/Record Button
15. Mobile Device Slot

Flight Safety

2 Flight Safety

After completing pre-flight preparations, it is recommended to train your flying skills and practice flying safely. Pick a suitable area to fly in according to the following flight requirements and restrictions. Strictly abide by local laws and regulations when flying. Read the *Safety Guidelines* before flight to ensure safe use of the product.

2.1 Flight Restrictions

GEO (Geospatial Environment Online) System

The DJI Geospatial Environment Online (GEO) System is a global information system that provides real-time information on flight safety and restriction updates and prevents UAVs from flying in restricted airspace. Under exceptional circumstances, restricted areas can be unlocked to allow flights. Prior to that, you must submit an unlocking request based on the current restriction level in the intended flight area. The GEO system may not fully align with local laws and regulations. You are responsible for your own flight safety and must consult with the local authorities on the relevant legal and regulatory requirements before requesting to unlock a restricted area. For more information about the GEO system, visit <https://fly-safe.dji.com>.

Flight Limits

For safety reasons, flight limits are enabled by default to help you operate the aircraft safely. You can set flight limits on height and distance. Altitude limits, distance limits, and GEO zones function concurrently to manage flight safety when Global Navigation Satellite System (GNSS) is available. Only altitude can be limited when GNSS is unavailable.

Flight Altitude and Distance Limits

Max altitude restricts the flight altitude of the aircraft, while max distance restricts the flight radius around the Home Point of the aircraft. These limits can be changed in the DJI Fly app for improved flight safety.



- When using Palm Control and Mobile App Control, the max flight altitude is 30 m and the max flight distance is 50 m. These limits can not be changed in the DJI Fly app. The following information is suitable for when using the aircraft with the remote control devices.
-

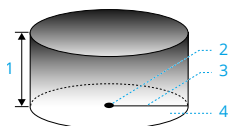

1. Max Altitude
2. Home Point (Horizontal Position)
3. Max Distance
4. Height of aircraft when taking off

Strong GNSS Signal

	Flight Restrictions	Prompt in DJI Fly App
Max Altitude	Altitude of the aircraft cannot exceed the value set in DJI Fly.	Max flight altitude reached.
Max Distance	The straight-line distance from the aircraft to the Home Point cannot exceed the max flight distance set in DJI Fly.	Max flight distance reached.

Weak GNSS Signal

	Flight Restrictions	Prompt in DJI Fly App
Max Altitude	<ul style="list-style-type: none"> • Altitude is restricted to 30 m from the takeoff point if lighting is sufficient. • Altitude is restricted to 2 m above the ground if lighting is not sufficient and the infrared sensing system is functioning. • Altitude is restricted to 30 m from the takeoff point if lighting is not sufficient and the infrared sensing system is not functioning. 	Max flight altitude reached.
Max Distance	No limit	

- ⚠
- Each time the aircraft is powered on, the altitude limit of 2 m or 30 m will be automatically removed as long as the GNSS signal becomes strong (GNSS signal strength ≥ 2), and the limit will not take effect even if the GNSS signal becomes weak afterwards.
 - If the aircraft flies out of the set flight range due to inertia, you can still control the aircraft but cannot fly it any further away.

GEO Zones

The DJI GEO system designates safe flight locations, provides risk levels and safety notices for individual flights, and offers information on restricted airspace. All restricted flight areas are referred to as GEO Zones, which are further divided into Restricted Zones, Authorization Zones, Warning Zones, Enhanced Warning Zones, and Altitude Zones. You can view such information in real-time in DJI Fly. GEO Zones are specific flight areas, including but not limited to airports, large event venues, locations where public emergencies have occurred (such as forest fires), nuclear power plants, prisons, government properties, and military facilities. By default, the GEO system limits takeoffs and flights in zones that may cause safety or security concerns. A GEO Zone map that contains comprehensive information on GEO Zones around the globe is available on the official DJI website: <https://fly-safe.dji.com/nfz/nfz-query>.

Unlocking GEO Zones

To satisfy the needs of different users, DJI provides two unlocking modes: Self-Unlocking and Custom Unlocking. You can make a request on the DJI Fly Safe website.

Self-Unlocking is intended for unlocking Authorization Zones. To complete Self-Unlocking, you must submit an unlocking request via the DJI Fly Safe website at <https://fly-safe.dji.com>. Once the unlocking request is approved, you can synchronize the unlocking license through the DJI Fly app. To unlock the zone, alternatively, you can launch or fly the aircraft directly into the approved Authorization Zone and follow the prompts in DJI Fly to unlock the zone.

Custom Unlocking is tailored for users with special requirements. It designates user-defined custom flight areas and provides flight permission documents specific to the needs of different users. This unlocking option is available in all countries and regions and can be requested via the DJI Fly Safe website at <https://fly-safe.dji.com>.

-
-  • To ensure flight safety, the aircraft will not be able to fly out of the unlocked zone after entering it. If the Home Point is outside the unlocked zone, the aircraft will not be able to return home.
-

2.2 Flight Environment Requirements

1. DO NOT operate DJI Neo in severe weather conditions including in wind speeds exceeding 8 m/s, snow, rain, and fog.
2. Only fly in open areas. Tall buildings, large metal structures, mountains, and wooded areas may obstruct signals and cause electromagnetic wave interference or magnetic interference, which can lead to poor positioning or a positioning error. Therefore, DO

NOT take off from a balcony or anywhere within 15 m of buildings. Keep a distance of at least 15 m from buildings during flight. When using the aircraft with the remote control device, after takeoff, make sure you are notified with the prompt "Home Point is updated" before continuing flight. If the aircraft has taken off near buildings, the accuracy of the Home Point cannot be guaranteed. In this case, pay close attention to the current position of the aircraft during auto RTH. When the aircraft is close to the Home Point, it is recommended to cancel auto RTH and manually control the aircraft to land in an appropriate location.

3. Fly DJI Neo in environments that have good lighting and clearly textured surfaces, without strong reflections and dynamic changes. The vision system may not work properly in the following scenarios: in poor lighting conditions, over surfaces without clear textures, surfaces with strong reflections (such as car roofs, monochrome ceramic tiles, and glass), scenes with dynamic changes (such as above water, moving people, swaying shrubs, and grass). Only fly DJI Neo in the daytime.
4. Fly DJI Neo within visual line of sight (VLOS). Any flight beyond visual line of sight (BVLOS) can be conducted only when the device performance, the pilot's knowledge and skills, and the operational safety management are compliant with local regulations for BVLOS. Avoid flying near obstacles and crowds. DO NOT fly near airports, highways, railway stations, railway lines, city centers, or other sensitive areas, unless a permit or approval is obtained under local regulations.
5. Try to keep a distance of more than 200 m from strong electromagnetic wave interference sites, such as radar stations, microwave relay stations, mobile communication base stations, and communication jamming equipment.
6. Minimize interference by avoiding areas with high levels of electromagnetism, such as locations near power lines, base stations, electrical substations, broadcasting towers, Wi-Fi hotspots, routers, and Bluetooth devices. Avoid flying more than one DJI Neo in the area.
7. DJI Neo uses only the vision system for positioning in polar regions.
8. DO NOT take off from moving objects, such as cars and boats.
9. DO NOT take off when there is a significant change in the ground level (such as near cliffs).
10. Be careful when taking off in the desert or from a beach to avoid sand entering DJI Neo.
11. DO NOT operate DJI Neo in an environment at risk of a fire or explosion.
12. Operate the aircraft, remote control devices, battery, battery charger, and the battery charging hub in a dry environment.

13. DO NOT use the aircraft, remote control devices, battery, battery charger, and the battery charging hub near accidents, fires, explosions, floods, tsunamis, avalanches, landslides, earthquakes, dust, sandstorms, salt spray, or fungus.
14. DO NOT operate the aircraft near bird flocks.

2.3 Operating the Aircraft Responsibly

To avoid serious injury and property damage, observe the following rules:

1. Make sure you are NOT under the influence of anesthesia, alcohol, or drugs or suffering from dizziness, fatigue, nausea, or other conditions that could impair the ability to operate the aircraft safely.
2. After landing, power off the aircraft first, then switch off the remote controller.
3. DO NOT drop, launch, fire, or otherwise project any dangerous payloads on or at any buildings, persons, or animals, which could cause personal injury or property damage.
4. DO NOT use an aircraft that has been accidentally damaged, crashed, or is not in good condition.
5. Make sure to train sufficiently and have contingency plans for emergencies or if an incident occurs.
6. Make sure to have a flight plan. DO NOT fly the aircraft recklessly.
7. Respect the privacy of others when using the camera. Make sure to comply with local privacy laws, regulations, and moral standards.
8. DO NOT use this product for any reason other than general personal use.
9. DO NOT use it for illegal or inappropriate purposes such as spying, military operations, or unauthorized investigations.
10. DO NOT use this product to defame, abuse, harass, stalk, threaten, or otherwise violate legal rights such as the right to privacy and publicity of others.
11. DO NOT trespass onto the private property of others.

2.4 Pre-Flight Checklist

1. Make sure the gimbal protector has been removed.
2. Make sure the Intelligent Flight Battery and the propellers are mounted correctly and are firmly secure.
3. Make sure all the devices are fully charged.
4. Make sure the gimbal and camera are functioning normally.

5. Make sure that there is nothing obstructing the motors and that they are functioning normally.
6. Make sure all camera lenses and sensors are clean.
7. When using Palm Control, make sure that DJI Neo has previously connected to DJI Fly on your smartphone via Wi-Fi and the app works properly.

When using the remote controller, make sure that the remote controller and DJI Fly are successfully connected to the aircraft.

8. Make sure the max flight altitude, max flight distance, and RTH altitude are all set properly in DJI Fly or the goggles (if in use) according to local laws and regulations.
9. Only use genuine DJI parts or DJI-authorized parts. Unauthorized parts may cause DJI Neo to malfunction and compromise the safety of the product.

Flight Operation

3 Flight Operation

DJI Neo supports multiple control methods for various scenarios to meet your needs. Make sure you are familiar with the notice and usage for each control method before flight.



-
-  • DJI Neo does not feature obstacle sensing. Fly with caution.
 - DO NOT touch DJI Neo mid-flight. Otherwise, DJI Neo may drift and a collision may occur.
 - DO NOT fly DJI Neo immediately after it has been in a collision or severely knocked or shaken. DJI Neo may not be able to perform stable flight.
-

3.1 Palm Control

In Palm Control, palm takeoff and landing is supported. You can use the mode button on DJI Neo to achieve multiple Smart Snaps. DJI Neo will fly while recording automatically after subject confirmation.* Connect to the DJI Fly app using the Wi-Fi function to adjust the parameters for each mode. Refer to the [Mobile App Control](#) section to learn more. The default settings are used as an example.

* Smart Snaps only supports the tracking of people.

Notice

-
-  • Power off the remote control devices and goggles connected to the aircraft before using Palm Control.
-
-  • Make sure that the flight environment meets the flight requirements and that you can control and retrieve DJI Neo immediately when an issue occurs or in an emergency. In situations where DJI may not be able to analyze the cause of the incident, it may not be possible for DJI to provide warranty and other aftersales services.
 - Before using Palm Control, make sure that DJI Neo has previously connected to DJI Fly on your smartphone via Wi-Fi. When using Palm Control without the app, if DJI Neo malfunctions mid-flight, you can choose to connect it to DJI Fly via Wi-Fi and control it manually to avoid an accident.
 - Make sure to fly in an open and unobstructed environment without Wi-Fi signal interference.
 - When using Palm Control, the max flight altitude of DJI Neo is 30 m and the max flight distance is 50 m.

- Return to Home (RTH) is not supported in Palm Control. Maintain visual line of sight (VLOS) within a controlled area.
 - DO NOT fly over water.
 - DJI Neo will land automatically in the following situations. Make sure to observe the operating environment to avoid DJI Neo being lost or damaged due to the landing.
 - Critical low battery.
 - Positioning fails and DJI Neo enters Attitude mode.
 - DJI Neo detects a collision but does not crash.
 - Observe the following rules when taking off from or landing on the palm of your hand:
 - Operate DJI Neo in a windless environment whenever possible.
 - Extend your fingers and keep still. DO NOT place your fingers in the propeller guards or the propeller rotation range to avoid injury or damage.
 - DO NOT perform takeoff or landing when moving. Otherwise, DJI Neo may drift and a collision may occur. During landing, DJI Neo may fail to stop the motors when your hand is moving.
 - DO NOT throw DJI Neo during takeoff.
 - DO NOT grab DJI Neo by hand.
 - To land on your palm, place your hand right under DJI Neo to prevent it from falling after landing.
 - Take off in an environment with sufficient lighting and a richly textured surface. DO NOT fly to an environment that has a significant difference in lighting from the current location.
 - If DJI Neo fails to perform palm takeoff or landing, follow the voice prompt of DJI Neo for troubleshooting or connect to the DJI Fly app for details. Voice prompt supports English or Mandarin according to the app language setting for the latest connection. Other languages are not supported.
-

Switching Modes

The default mode is Follow after powering on the device for the first time. Press the mode button once to switch to Dronie, Circle, Rocket, Spotlight, or Custom.

The default Custom mode is DirectionTrack.* Connect DJI Neo to the mobile app via Wi-Fi to select Helix or Boomerang. You can also adjust the parameters for each mode in the app accordingly before flight.

* Update firmware to the latest version. Otherwise, the function may not be supported.

- 💡 • When using DirectionTrack for the first time, connect DJI Neo to the DJI Fly app and follow the tutorial to unlock this mode.
-

After switching the mode, the aircraft will voice prompt the selected mode, and the corresponding mode indicator on top of DJI Neo will light up.

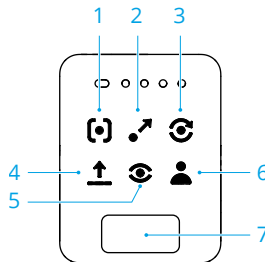

1. Follow

DJI Neo will follow the subject from behind while recording automatically. When the subject moves away from DJI Neo, it will follow the subject and fly forward. When the subject moves toward DJI Neo, it will hover in place and does not fly backward. Perform with caution to avoid collision. The max horizontal flight speed in Follow mode is 5.5 m/s.

You can set the follow distance and height in the DJI Fly app.

- ⚠️ • DJI Neo does not support obstacle sensing. To ensure flight safety, it is recommended to fly within visual line of sight.
 - Make sure the flight environment is open and unobstructed with sufficient lighting.
 - 💡 • When the subject is not in the camera field of view, such as when a sharp turn is made or the subject is obstructed by an obstacle, DJI Neo will hover due to losing the subject. The subject should return to the camera field of view for successful subject confirmation.
-

2. Dronie

DJI Neo will keep the camera facing the original position of the subject, record a video while flying backward, and then record another video while flying forward. It will hover at the takeoff point after recording.

You can set the max distance and height in the DJI Fly app.

3. Circle

DJI Neo will keep the camera facing the subject, fly backward to the preset distance, and then begin circling the subject once, while recording automatically. It will hover at the takeoff point after recording.

You can set the distance in the DJI Fly app.

4. Rocket

DJI Neo will keep the camera facing the original position of the subject, record a video while ascending, and then record another a video while descending. It will hover at the takeoff point after recording.

You can set the max height and enable or disable the rotation of DJI Neo when ascending and descending in the DJI Fly app.

5. Spotlight

DJI Neo will hover after takeoff and record a video with the camera facing the subject.

You can set the camera mode to Photo or Video in the DJI Fly app. When set to Photo, the subject can trigger DJI Neo to take a photo automatically by maintaining a fixed pose for 3 seconds.

6. Custom

DirectionTrack

DJI Neo will fly backward for a distance after takeoff and then determine the movement direction of the subject to confirm the tracking direction. Once confirmed, DJI Neo will follow the subject from the tracking direction relative to the direction of the subject movements while recording.

You can set the follow distance and height in the DJI Fly app.

DJI Neo may switch to following the subject from behind when the movement or direction of the subject changes too fast related to DJI Neo. Once DJI Neo confirms the direction of the subject again, it will switch back to the original tracking direction.

To exit DirectionTrack, face DJI Neo and stay still. DJI Neo will fly back to the subject.

-
-  • DJI Neo does not support obstacle sensing. To ensure flight safety, it is recommended to fly within visual line of sight.
 - Make sure the flight environment is open and unobstructed with sufficient lighting.

-
-  • When the subject is not in the camera field of view, such as when a sharp turn is made or the subject is obstructed by an obstacle, DJI Neo will hover due to losing the subject. The subject should return to the camera field of view for successful subject confirmation.

Helix

DJI Neo will keep the camera facing the subject, fly backward to a location 2 m from the takeoff point, and ascend while circling the subject once in a spiral curve while recording automatically. It will hover at the takeoff point after recording.

You can set the max distance in the DJI Fly app.

Boomerang

DJI Neo will keep the camera facing the subject and fly around the subject along an oval path while recording automatically. It will ascend and then descend while flying along the oval path and will reach the max height when flying at the farthest point away from the takeoff point. DJI Neo will hover at the takeoff point after recording.

You can set the max distance in the DJI Fly app.

7. Mode Button

Press once to switch the mode. Press and hold to perform palm takeoff.

Cancel palm takeoff by pressing the mode button once before the countdown voice prompt ends.

Palm Takeoff/Landing and Smart Snaps

 • Make sure to follow local privacy laws and regulations when using Smart Snaps.

1. Power on DJI Neo. Keep it still and wait for the system self-diagnostics to complete.
2. Make sure to leave enough room for maneuvering according to the preset parameters such as distance and height. Press the mode button on top of DJI Neo to select your desired mode.
3. Follow the steps below for palm takeoff.

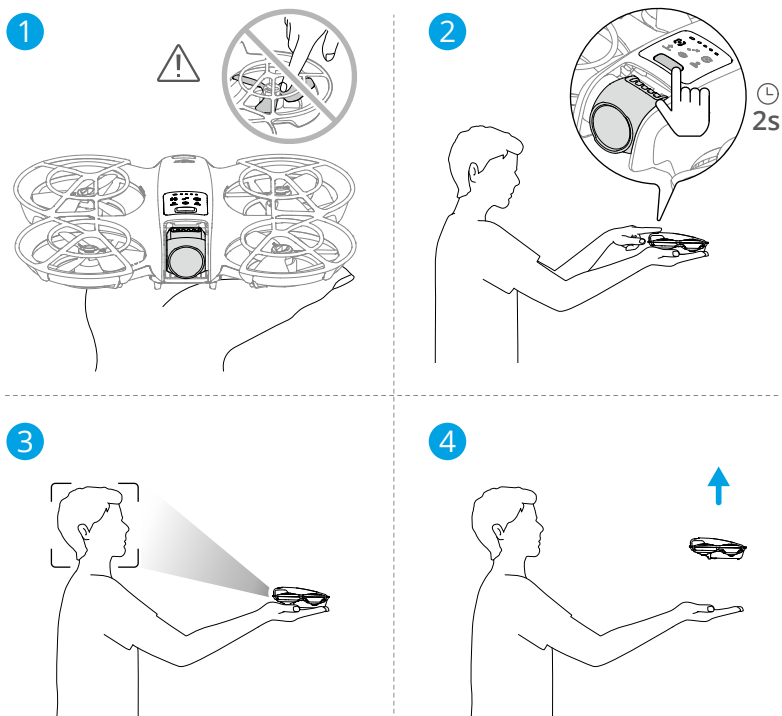

- a. Palm takeoff requires subject confirmation. Place DJI Neo on your hand with the camera facing the subject. Make sure that your hand does not block the camera and there are no obstacles obstructing the takeoff.
- b. Extend your arm, face the camera toward the subject, and keep it steady. Press and hold the mode button. DJI Neo will voice prompt the selected mode and the countdown, and then take off automatically.

-
- ☀️ • When the subject is obstructed by an obstacle or the environment lighting is not suitable, takeoff may fail.
 - To cancel palm takeoff, press the mode button once before the countdown voice prompt ends.
 - When using palm takeoff, DJI Neo will fly backward for a short distance after takeoff. Pay attention to the rear of DJI Neo to ensure flight safety.
-

4. DJI Neo will start recording or take photos according to the selected mode and its preset parameters.
5. Palm landing:

In DirectionTrack mode, face DJI Neo and keep still. Wait for DJI Neo to fly forward before performing palm landing.

In other modes, make sure that DJI Neo is hovering in place, move toward it, and then perform palm landing.

Follow the instructions below for palm landing.

- a. Make sure that DJI Neo is hovering in place. Move toward DJI Neo, extend your arm, and then place your hand right under it.
- b. Keep your hand still and extend your fingers. Wait for DJI Neo to land automatically. The effective height range of palm landing is within 0.7 m under DJI Neo.

-
-  • During palm landing, DJI Neo may ascend slightly and then land on the palm. Keep your hand still and extend your fingers during the process.
-

6. Connect DJI Neo to DJI Fly to view the footage and create short videos. Refer to the [Mobile App Control](#) section for details.

-
-  • In Follow, Spotlight, and DirectionTrack modes, DJI Neo will hover in place if the camera loses the subject while recording. Run DJI Fly on your smartphone via Wi-Fi to connect to DJI Neo mid-flight. The smartphone must have been connected to DJI Fly previously in order to connect. In the Controls view, make sure that the task has already stopped, select **Manual Control** from the mode list, and then land DJI Neo using the virtual joysticks.
-

3.2 Mobile App Control

To use Mobile App Control, connect DJI Neo to the DJI Fly app on the smartphone via Wi-Fi and control DJI Neo in the app. In Mobile App Control, all the functions for Palm Control are available. You can set parameters and perform Smart Snaps in the app. More functions such as manual control, audio recording*, and voice control* are also supported.

* Update firmware to the latest version. Otherwise, the function may not be supported.

Notice

-
-  • Power off the remote control devices and goggles that are connected to the aircraft before using Mobile App Control. If not powered off, the aircraft

will disconnect from the other devices automatically when the smartphone is connected via Wi-Fi and the Controls view in the app is opened.

- ⚠ • Make sure to fly in an open and unobstructed environment without Wi-Fi signal interference. Otherwise, the app may disconnect from DJI Neo which may affect flight safety.
 - When using Mobile App Control, the max flight altitude of DJI Neo is 30 m and the max flight distance is 50 m.
 - Return to Home (RTH) is not supported in Mobile App Control. Maintain visual line of sight within a controlled area.
 - DO NOT fly over water.
 - DJI Neo will land automatically in the following situations. Make sure to observe the operating environment to avoid DJI Neo to be lost or damaged when landing.
 - Critical low battery.
 - Positioning fails and DJI Neo enters Attitude mode.
 - DJI Neo detects a collision but does not crash.
-

Connecting DJI Neo

1. Power on DJI Neo and wait for the system self-diagnostics to complete.
 2. Enable Bluetooth, Wi-Fi, and location services on the smartphone.
 3. Tap **Connection Guide** on the bottom right corner of the home screen in the app, select the device model, and select **Connect via Mobile Device**.
 4. Select the desired device in the search results. The Controls view is displayed after connected successfully. When connecting the smartphone to DJI Neo for the first time, press and hold the power button of DJI Neo to confirm.
-

- 💡 • You can also tap the QuickTransfer or Wi-Fi Devices panel on the home screen in DJI Fly for Wi-Fi connection.
 - To change the smartphone connected to DJI Neo, disable Bluetooth and Wi-Fi on the currently connected smartphone before connecting DJI Neo to the new smartphone.
-

Smart Snaps

- ⚠ • Make sure to follow local privacy laws and regulations when using Smart Snaps.
-

1. Set parameters:

Go to the Settings view. Tap the specific mode to enter the parameter configuration screen. Tap **Custom** to set to DirectionTrack, Helix, or Boomerang and adjust the corresponding parameters.

Tap **Camera Settings** to set the same camera parameters for all the Smart Snaps modes.

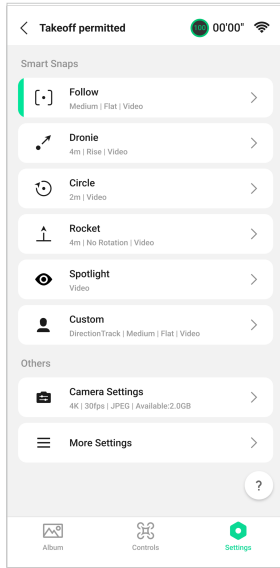

2. Start Smart Snaps:

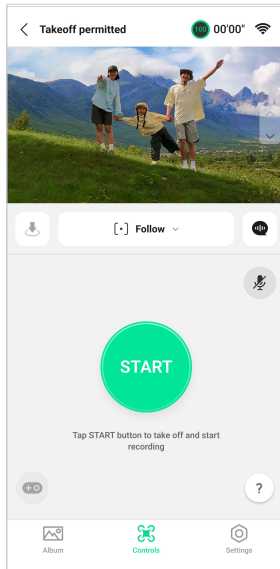

- a. Place DJI Neo stably with the camera facing the subject.
- b. Go to the Controls view. The current mode is displayed under the liveview. Tap to expand the option list and select your desired mode.
- c. Tap START. DJI Neo will take off automatically after it confirms the subject successfully and the countdown voice prompt is completed.



- When the subject is obstructed by an obstacle or the environment lighting is not suitable, subject confirmation may fail.
- You can also press and hold the mode button on top of DJI Neo to perform palm takeoff. Refer to the [Palm Control](#) section for related notices and procedures.

- d. DJI Neo will fly and record video automatically according to the selected mode and preset parameters. You can check the liveview and video recording duration.

In Spotlight mode, DJI Neo will hover in place and keep the camera facing the subject. When the camera mode is set to Photo, the subject can trigger DJI Neo to take a photo automatically by maintaining a fixed pose for 3 seconds.

3. Exit Smart Snaps:

The way to exit Smart Snaps varies for different modes.

Dronie, Circle, Rocket, Helix, Boomerang

DJI Neo will exit Smart Snaps after recording. When the recording task is not completed, you can tap STOP to finish recording. DJI Neo will hover in place.

Follow, Spotlight

During recording, tap STOP to exit Smart Snaps. You can also move toward DJI Neo to perform palm landing, and the recording will stop automatically. DJI Neo will hover in place.

DirectionTrack

During recording, tap STOP to exit Smart Snaps. DJI Neo will hover in place. The subject can also face DJI Neo and keep still to exit Smart Snaps. DJI Neo will stop recording and fly toward the subject. Palm landing can now be performed.

If you do not land DJI Neo, you can choose to start the same Smart Snaps task again in the app after exiting Smart Snaps. You can also land DJI Neo on your palm by following the instructions in the app. Or, tap  on the left of the mode list, and then tap and hold to land.



- Refer to the [Palm Control](#) section for related notices and procedures of palm landing.
-

View Album

Tap Album to view the captured footage.

For Dronie, Circle, Rocket, Helix, and Boomerang modes, tap **Create QuickShots** to preview the video. You can also select from other templates or edit the video manually.



- DJI Neo supports ECO mode. When viewing the album in the app via Wi-Fi connection to DJI Neo, in both Mobile App Control mode and QuickTransfer mode, ECO mode will be enabled automatically if DJI Neo rises above a certain temperature. Pay attention to the prompt in the app.
-

Manual Control

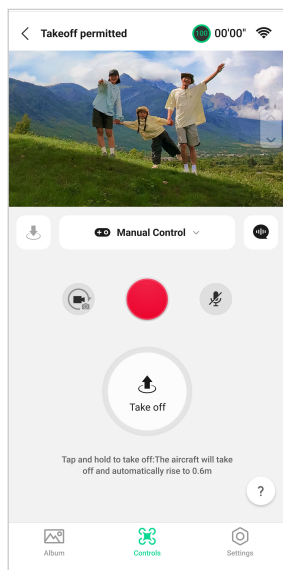

1. Place DJI Neo on flat ground.
2. In the Controls view, tap the mode list under the liveview, and select **Manual Control**.
3. Tap and hold . DJI Neo will start the motors and automatically rise to a height of 0.6 m.



You can also perform palm takeoff. Subject confirmation is not required for palm takeoff in manual control, which differs from Palm Control. Refer to the [Palm Control](#) section for related notices and procedures.

4. Control DJI Neo using the virtual joysticks in the app. The left stick controls the flight altitude and orientation. The right stick controls the forward, backward, left, and right movements.

 • DJI Neo does not support obstacle sensing. To ensure flight safety, it is recommended to fly within visual line of sight.

5. View the liveview in the camera view. Tap the photo/video toggle button to switch between photos and videos. Slide the slider on the right of the liveview to control the gimbal pitch.
6. In Photo mode, tap the shutter button to take a photo. In Video mode, tap the record button to start recording. Tap again to stop recording.
7. Tap and hold  to land DJI Neo. You can also perform palm landing.

Recording Audio via App

In the Controls view, tap  on the right of the screen to enable audio recording. The status will change to . Allow the microphone permission to record audio following the prompts.

When using Mobile App Control, audio will be recorded by the corresponding audio recording device while DJI Neo is recording a video. The microphone icon will be displayed in liveview.

Supported audio recording devices include the built-in microphone of the smartphone, DJI Mic 2, and Bluetooth earphones. Audio recording compatibility issues may occur when using some Bluetooth earphones. Make sure to test them before recording.



- DO NOT turn off the screen or switch to other apps during recording.



- Audio recording can only be enabled or disabled before recording.
 - When viewing or downloading the videos in the Album view in DJI Fly, the audio recorded using the audio recording function will be automatically merged into the video file.
-

Voice Control

In the Controls view, tap  on the right of the screen under the liveview to enable voice control. Use a voice command to control DJI Neo. Tap the corresponding button in the pop-up window to view the common commands.

You can also enable voice control via voice wake-up. Go to the Settings view, tap **More Settings > Control > Voice Control Settings**. Enable **Voice Wake-up** and allow the microphone permission following the prompts. When using Mobile App Control, say **Hey Fly** to wake up voice control and then control DJI Neo using voice commands. View the common commands in Voice Control Settings.





- Voice control supports English or Mandarin according to the app language.
 - Turn up the volume on the phone for the optimal experience when using voice control.
-

3.3 RC Control

Auto Takeoff

1. Launch DJI Fly and enter the camera view.
2. Complete all steps in the pre-flight checklist.
3. Tap . If conditions are safe for takeoff, press and hold the button to confirm.
4. The aircraft will take off and hover approximately 1.2 m (3.9 ft) above the ground.

Auto Landing

1. If conditions are safe to land, tap , then tap and hold  to confirm.
2. Auto landing can be canceled by tapping .
3. If the Downward Vision System is working normally, Landing Protection will be enabled.
4. Motors will stop automatically after landing.

 • Choose an appropriate place for landing.

Starting/Stopping the Motors

Starting the Motors

Perform one of the Combination Stick Commands (CSC) as shown below to start the motors. Once the motors have started spinning, release both sticks simultaneously.



Stopping the Motors

The motors can be stopped in two ways:

Method 1: When the aircraft has landed, push the throttle stick down and hold until the motors stop.



Method 2: When the aircraft has landed, perform one of the CSC as shown below until the motors stop.



Stopping the Motors Mid-Flight

 • Stopping the motors mid-flight will cause the aircraft to crash.

The default setting for **Emergency Propeller Stop** in the DJI Fly app is **Emergency Only**, which means that the motors can only be stopped mid-flight when the aircraft detects that it is in an emergency situation such as the aircraft is involved in a collision, a motor has stalled, the aircraft is rolling in the air, or the aircraft is out of control and is ascending or descending very quickly. To stop the motors mid-flight, perform the same CSC that was used to start the motors. Note that you need to hold the control sticks for two seconds while performing the CSC to stop the motors. **Emergency Propeller Stop** can be changed to **Anytime** in the app. Use this option with caution.

Controlling the Aircraft

The control sticks of the remote controller can be used to control the aircraft movements. The control sticks can be operated in Mode 1, Mode 2, or Mode 3, as shown below.

Mode 1

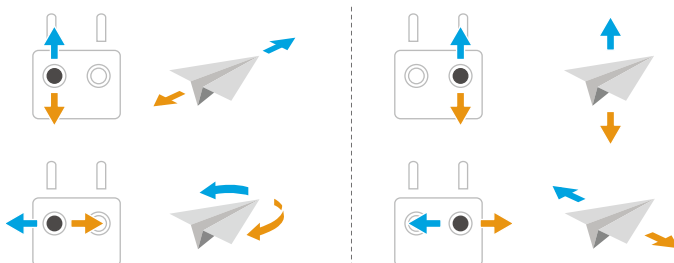

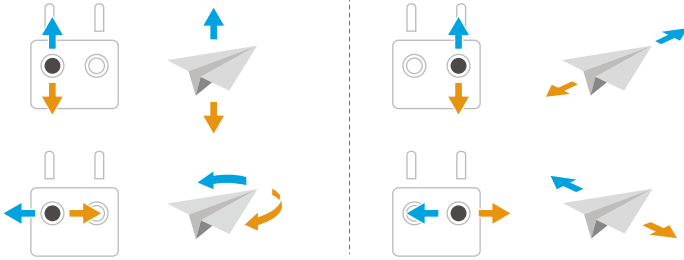

Mode 2



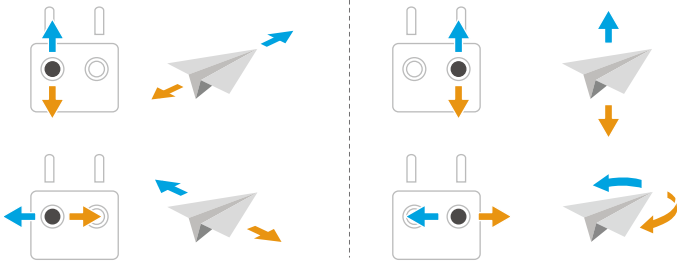



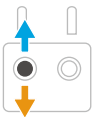

Mode 3

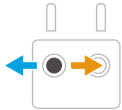

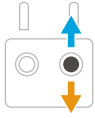
The default control mode of the remote controller is Mode 2. In this manual, Mode 2 is used as an example to illustrate how to use the control sticks.

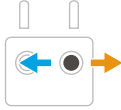
Remote Controller (Mode 2)	Aircraft	Operation
		<p>Throttle Stick</p> <ul style="list-style-type: none"> • Push the stick up to ascend and down to descend. • The more the stick is pushed away from the center, the faster the aircraft changes elevation. <p>Make sure to gently push the stick up when taking off to prevent sudden and unexpected changes in altitude.</p>

Remote Controller (Mode 2)	Aircraft	Operation
		<p>Yaw Stick</p> <ul style="list-style-type: none"> • Push the stick left to rotate the aircraft counterclockwise and right to rotate the aircraft clockwise. • The more the stick is pushed away from the center, the faster the aircraft rotates.
		<p>Pitch Stick</p> <ul style="list-style-type: none"> • Push the stick up to fly forward and down to fly backward. • The more the stick is pushed away from the center, the faster the aircraft moves.
		<p>Roll Stick</p> <ul style="list-style-type: none"> • Push the stick left to fly left and right to fly right. • The more the stick is pushed away from the center, the faster the aircraft moves.

Takeoff/Landing Procedures

-  • DO NOT operate the aircraft with the remote controller or mobile device to monitor flight when the lighting is too bright or too dark. You are responsible for the correct adjustment of display brightness and amount of direct sunlight on the screen, as to avoid difficulty in viewing the screen clearly.

1. The pre-flight checklist is designed to help the user fly safely. Go through the full pre-flight checklist before each flight.
2. Place the aircraft on an open, flat area with the rear of the aircraft facing towards you.
3. Power on the remote controller and the aircraft.
4. Launch DJI Fly and enter the camera view.
5. Tap *** > **Safety**, and then set an appropriate **Auto RTH Altitude** and **Max Altitude**.
6. Wait for the system self-diagnostics to complete. If DJI Fly does not show any irregular warning, you can start the motors.

7. Push the throttle stick up slowly to take off.
8. To land, hover over a level surface and push the throttle stick down to descend.
9. After landing, push the throttle down and hold until the motors stop.
10. Power off the aircraft before the remote controller.



- When using the remote controller, palm takeoff* is still supported by pressing and holding the mode button on top of DJI Neo. You can also perform palm landing to land the aircraft. Smart Snaps for Palm Control is not supported. The related notice and instructions are similar to those for Palm Control. The difference is that subject confirmation is not required before takeoff. Refer to the [Palm Control](#) section for more information.

* Update firmware to the latest version. Otherwise, the function may not be supported.

Intelligent Flight Modes

FocusTrack

FocusTrack includes Spotlight, Point of Interest (POI), and ActiveTrack.



- The aircraft does not automatically take photos or record videos while using FocusTrack. Manually control the aircraft to take photos or record videos.

Spotlight: Enables the camera to face the subject at all times, while manually controlling the flight.

POI: Allows the aircraft to fly around the subject based on the set radius and flight speed.

ActiveTrack: The aircraft follows a moving subject at a certain distance and altitude.

ActiveTrack can only track people.



- In ActiveTrack, you can use the remote controller to control the aircraft orientation, ascend or descend, or fly forward and backward.

In ActiveTrack, the supported follow ranges of the aircraft and subject are as follows:

Subject	People
Horizontal Distance	2-7 m (Optimal Distance: 2-5 m)
Altitude	0.5-5 m (Optimal Distance: 0.5-3 m)



- DJI Fly will prompt you if the distance and altitude is out of range when ActiveTrack begins. In this case, fly the aircraft manually to the supported range and start ActiveTrack again. Fly the aircraft at the optimal distance and altitude for the optimal tracking performance.

Notice

- ⚠ • This aircraft does not feature obstacle sensing. When using FocusTrack, pay attention to the surrounding environment to ensure flight safety.
 - Always be prepared to press the Flight Pause button on the remote controller or tap **Stop** in order to operate the aircraft manually in case an emergency situation occurs.
 - Be extra vigilant when using FocusTrack in any of the following situations:
 - The tracked subject is not moving on a level plane.
 - The tracked subject has large movements or changes pose.
 - The tracked subject is out of sight for an extended period.
 - The tracked subject is moving on a surface with snow.
 - The clothing of the tracked subject has a similar color or pattern to the surrounding environment.
 - The lighting is extremely dark (<15 lux) or bright (>10,000 lux).
 - Make sure to follow local privacy laws and regulations when using FocusTrack.
 - It is recommended to only track people. Fly with caution when tracking other subjects.
 - The tracking subject may be inadvertently swapped to another subject if they pass nearby each other.
 - ActiveTrack is unavailable when lighting is insufficient and the vision systems are unavailable. Spotlight and POI for static subjects can still be used, but obstacle sensing is not available.
 - FocusTrack is unavailable when the aircraft is on the ground.
 - FocusTrack may not function properly when the aircraft is flying near its flight limit or in a GEO Zone.
 - In Photo mode, FocusTrack is only available when using Single.
 - If the subject is obstructed and is lost by the aircraft, the aircraft will hover to try and re-confirm the subject. If the aircraft fails to re-identify the subject, it will exit ActiveTrack automatically and hover.
-

Using FocusTrack

Before enabling FocusTrack, make sure the flight environment is open and unobstructed with sufficient light.

1. Drag-select the subject in the camera view in DJI Fly, or tap ******* > **Control**, enable **Subject Scanning**, and tap the recognized subject to lock the subject.
2. Spotlight is the default mode once entering FocusTrack. In Spotlight, the aircraft does not fly automatically, but the camera remains locked on the subject while manually controlling the flight. Press the Shutter/Record button on the remote controller or the screen to start taking photos or recording video.

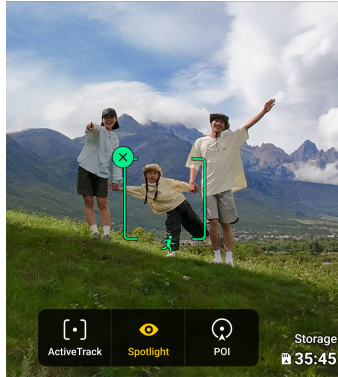

3. Tap on the bottom of the screen to switch to Point of Interest. After setting the flight direction and speed, tap **GO** to start circling around the subject at the current altitude. Press the Shutter/Record button on the remote controller or the screen to start taking photos or recording video.

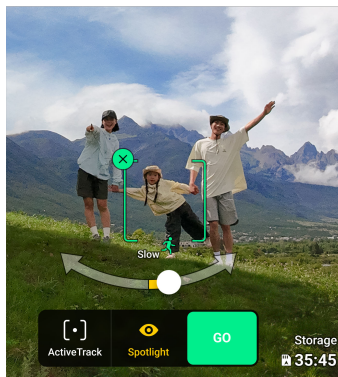

4. Tap on the bottom of the screen to switch to ActiveTrack. Tap **GO** and the aircraft will start tracking the subject automatically. Press the Shutter/Record button on the remote controller or the screen to start taking photos or recording video.

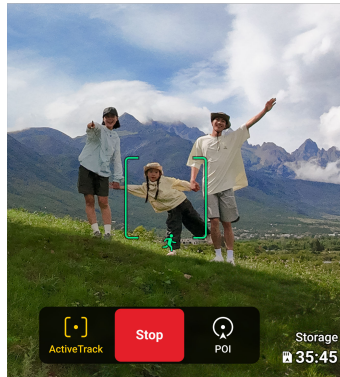

Exiting FocusTrack

In POI or ActiveTrack, press the Flight Pause button on the remote controller or tap **Stop** on the screen to return to Spotlight first. In Spotlight, press the Flight Pause button on the remote controller to exit FocusTrack.

QuickShots



QuickShots include shooting modes such as Dronie, Rocket, Circle, Helix, and Boomerang. The aircraft automatically records according to the selected shooting mode and generates a short video.

Notice

- ⚠️ • Make sure there is sufficient space when using Boomerang. Allow a radius of at least 30 m (99 ft) around the aircraft and a space of at least 10 m (33 ft) above the aircraft.
- Make sure there is sufficient space when using Asteroid. Allow at least 40 m (131 ft) behind and 50 m (164 ft) above the aircraft.
- Use QuickShots at locations that are clear of buildings and other obstacles. Make sure there are no people, animals, or other obstacles in the flight path.
- Always pay attention to objects around the aircraft and use the remote controller to avoid collisions or the aircraft being obstructed.
- Accidentally moving a control stick will also stop the recording. The recording will also stop if the aircraft flies too close to a restricted zone or altitude zone, or if the aircraft's sensing system is triggered during the flight.

- DO NOT use QuickShots in any of the following situations:
 - When the subject is blocked for an extended period of time or outside the visual line of sight.
 - When the subject is more than 10 m away from the aircraft.
 - When the subject is similar in color or pattern with the surroundings.
 - When the subject is in the air.
 - When the subject is moving fast.
 - The lighting is extremely dark (<15 lux) or bright (>10,000 lux).
- DO NOT use QuickShots in places close to buildings or where the GNSS signal is weak. Otherwise, the flight path will become unstable.
- Make sure to follow local privacy laws and regulations when using QuickShots.

Using QuickShots

1. Launch and hover the aircraft at least 2 m (6.6 ft) above the ground.
2. Tap the Shooting Mode icon on the right side of the camera view and select QuickShots .
3. After selecting one sub-mode, tap the plus icon or drag-select the subject on the screen. Then tap  to begin shooting. The aircraft will record footage while performing a preset flight movement according to the option selected, and generate a video afterwards. The aircraft will fly back to its original position once recording is finished.

Exiting QuickShots

Tap  or press the Flight Pause button on the remote controller once. The aircraft will exit QuickShots immediately and hover.

Video Playback

After recording is complete, tap the Playback button  to preview the footage.

Tap **Create QuickShots** to preview the QuickShots video.

Cruise Control

Cruise Control enables the aircraft to fly at a constant speed automatically, which makes long distance flights effortless, and helps to avoid image shaking which often happens

during manual operation. More camera movements, such as spiraling up, can be achieved by increasing control stick input.

1. Setting the Cruise Control Button

To use the function, you have to set a cruise control shortcut button first. Tap ***** > Control > Button Customization** in the camera view of DJI Fly, and set one customizable button of the remote controller to **Cruise Control**.

2. Entering Cruise Control

- While pushing the control sticks, press the cruise control button once, the aircraft will keep flying automatically at the current speed. The control sticks can now be released.
- Push the control sticks after returning to the center, and the aircraft will fly at the updated speed based on the previous speed. In this case, press the cruise control button again, and the aircraft will automatically fly at the updated speed.

3. Exiting Cruise Control

To exit cruise control, press the Flight Pause button on the remote controller once, tap  on the camera view, or press the cruise control button once when not moving any control stick. The aircraft will then brake and hover.



- Cruise control is available when you are manually operating the aircraft in Normal, Cine, and Sport mode. Cruise control is also available when using APAS, Free Hyperlapse, and Spotlight.
 - Cruise control cannot be started without a control stick input.
 - The aircraft cannot enter or will exit cruise control in the following situations:
 - When near the max altitude or max distance.
 - When the aircraft disconnects from the remote controller or DJI Fly.
 - When the aircraft senses an obstacle and thus brakes and hovers in place.
 - When the aircraft is taking off, returning to home, or landing.
 - When switching flight modes.
 - DJI Neo does not feature obstacle sensing. Fly with caution.
-

3.4 Video Recording Suggestions and Tips

1. The pre-flight checklist is designed to help the user fly safely and shoot videos during flight. Go through the full pre-flight checklist before each flight.

2. If using the remote controller, it is recommended to take photos or record videos when flying in Normal or Cine mode.
3. DO NOT fly in bad weather such as on rainy or windy days.
4. Choose the camera settings that best suit your needs.
5. Perform flight tests to establish flight routes and preview scenes.
6. Make sure to control DJI Neo gently to ensure a smooth and stable flight.
7. Clear any foreign objects from the air intake on both sides of DJI Neo after flight to prevent a blockage.

DJI Neo

4 DJI Neo

4.1 Flight Modes

When using Palm Control and Mobile App Control, DJI Neo does not support the switching of flight modes.

When using the DJI RC-N3 Remote Controller, flight modes can be switched between Normal, Sport, and Cine using the flight mode switch on the remote controller.

When using the motion controller, flight modes can be switched between Normal and Sport using the mode button on the motion controller.

When using the FPV remote controller, flight modes can be switched between Normal, Sport, and Manual using the flight mode switch on the remote controller.

Normal Mode: The aircraft can hover precisely and fly stably and is suitable for most flight scenarios.

Sport Mode: The maximum horizontal flight speed of the aircraft will increase in Sport mode.

Cine Mode: Cine mode is based on Normal mode with a limited flight speed, making the aircraft more stable during recording.

Manual Mode: Classic FPV aircraft control mode with the highest maneuverability. In Manual mode, all flight assistance functions including precise hovering and auto-brake are disabled and proficient control skills are required.

DJI Neo automatically changes to Attitude (ATTI) mode when positioning does not work properly. In ATTI mode, DJI Neo may drift horizontally, and precise hovering and braking are unavailable. You should land DJI Neo as soon as possible to avoid any accidents to occur. Avoid flying in confined spaces or in areas where the lighting is not sufficient. Otherwise, DJI Neo will enter ATTI mode, which may present hazards.



- The flight modes are only effective for manual flight using a remote control device.
- Manual mode is only supported when using the DJI FPV Remote Controller 3, and the throttle stick can also be adjusted. Refer to the DJI FPV Remote Controller 3 User Manual for more information.



- The maximum flight speed and braking distance of the aircraft significantly increases in Sport mode. A minimum braking distance of 15 m is required in windless conditions.
- A minimum braking distance of 5 m is required in windless conditions while the aircraft is ascending and descending in Sport mode or Normal mode.

- The responsiveness of the aircraft significantly increases in Sport mode, which means a small control stick movement on the remote control device translates into the aircraft moving a large distance. Make sure to maintain adequate maneuvering space during flight.
 - You may experience shaking in videos recorded in Sport mode.
 - DJI Neo can be used as an entry-level drone for Manual mode. It is suitable for practicing throttle control, maintaining altitude, and level flight, but not for continuous high-speed flights and high-maneuverability actions such as Dive, Split-S, Power Loop, and Yaw-Spin. Otherwise, the attitude of the aircraft may be unable to be controlled due to the propulsion limit.
 - In Manual mode, when you switch to Normal or Sport mode, brake, or when the aircraft reaches the max flight altitude limit, the aircraft may enter ATTI mode and cannot hover stably if the environment does not meet the flight requirements or the vision system working requirements.
 - When the flight altitude of the aircraft is less than 5 m or when there are obstacles within a radius of 5 m around the aircraft, use with caution when enabling Manual mode. The attitude may become unstable when turning the aircraft in Manual mode in the following situations. Operate the aircraft with caution to ensure a stable flight.
 - When turning the aircraft at a high speed.
 - When diving or rolling rapidly.
 - When the flight speed exceeds 8 m/s or the wind speed exceeds 8 m/s.
-



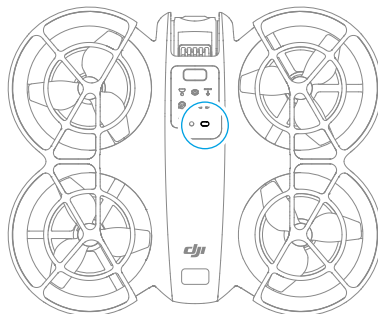

4.2 Status Indicator

DJI Neo has one status indicator located on top.







Status Indicator Descriptions

Normal States

	Blinks red, yellow, and green alternately	Powering on and performing self-diagnostic tests
	Blinks yellow four times	Warming up
	Blinks green slowly	Positioning functions properly
	Blinks purple slowly	The aircraft is in Manual mode

Warning States

	Blinks red slowly	Takeoff is disabled (e.g., low battery) ^[1]
	Blinks red quickly	Critically low battery
	Solid red	Critical error
	Blinks red and yellow alternately	Compass calibration required

[1] If DJI Neo cannot takeoff while the status indicator is blinking red slowly, view the warning prompt in DJI Fly.

4.3 Return to Home (RTH)

Read this section carefully and make sure that you are familiar with the aircraft action during Return to Home (RTH).

When using the aircraft with remote control devices, RTH is supported. The RTH function will automatically fly the aircraft back to the last recorded Home Point. RTH can be triggered in three ways: the user actively triggers RTH, the aircraft has low battery, or the remote control signal or video transmission signal has been lost (Failsafe RTH is triggered). If the aircraft records the Home Point successfully and the positioning system is functioning normally, when the RTH function is triggered, the aircraft will automatically fly back and land at the Home Point.



- Home Point: The Home Point will be recorded at takeoff as long as the aircraft has a strong GNSS signal  26. After the Home Point is recorded, a prompt will appear in the DJI Fly app or the goggles. If it is necessary to update the Home Point during a flight (such as if you have changed position), the Home Point can be manually updated in settings in the DJI Fly app or the goggles.

When using the aircraft with the remote controller, during RTH, the AR RTH route will be displayed in the camera view, in order to view the return path and ensure flight safety. The camera view also displays the AR Home Point. When the aircraft reaches above the Home Point, the gimbal camera will automatically point downwards. The AR aircraft

shadow will appear in the camera view when the aircraft is approaching the ground, enabling you to control the aircraft to land more accurately in your preferred location.

The AR Home Point, AR RTH route, and AR aircraft shadow will be displayed in the camera view by default. The display can be changed in DJI Fly. Go to camera view, tap *** > Safety > AR Settings.

- ⚠ • The AR RTH route is only used for reference, and may deviate from the actual flight route in different scenarios. Always pay attention to the liveview on the screen during RTH. Fly with caution.
- During RTH, the aircraft will automatically adjust the gimbal tilt to point the camera toward the RTH route by default. Adjusting the camera orientation manually will stop the aircraft from automatically adjusting the gimbal tilt, which may prevent the AR RTH route from being viewed.

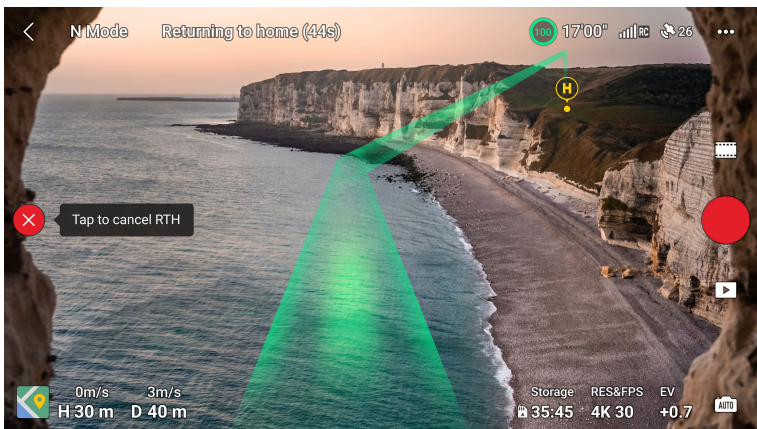

Notice

- ⚠ • The aircraft may not be able to return to the Home Point normally if the positioning system is functioning abnormally. During Failsafe RTH, the aircraft may enter ATTI mode and land automatically if the positioning system is functioning abnormally.
- When the aircraft is flying in an environment surrounded by obstacles (such as near tall buildings or under trees), the location of the Home Point displayed in the liveview may be inaccurate. Fly with caution.
- It is important to set a suitable RTH altitude before each flight. Launch DJI Fly and set the RTH altitude. The default RTH altitude is 30 m.

- GEO zones may affect RTH. Avoid flying near GEO zones.
 - The aircraft may not be able to return to the Home Point when the wind speed is too high. Fly with caution.
 - If the max altitude is adjusted below the current altitude during RTH, the aircraft will descend to the max altitude first and then continue returning to home.
 - The RTH Altitude cannot be changed during RTH.
 - When the remote controller signal is normal during RTH, the pitch stick can only be used to control the flight speed. The orientation and altitude cannot be controlled and the aircraft cannot be controlled to fly to the left or right. Constantly pushing the pitch stick to accelerate will increase the battery power consumption speed. The aircraft will brake and hover in place and exit RTH if the pitch stick is pushed all the way down. You will regain control of the aircraft after the pitch stick is released.
 - If the Home Point is within the Altitude Zone but the aircraft is not, when the aircraft reaches the Altitude Zone it will descend below the altitude limit, which may be lower than the set RTH altitude. Fly with caution.
 - RTH cannot be triggered during auto landing.
-

Trigger Method

The user actively triggers RTH

Using the remote controller: During flight, you can trigger RTH by pressing and holding the RTH button on the remote controller, or tapping  on the left side of the camera view in DJI Fly and then pressing and holding the RTH icon.

Using the motion controller: Press and hold the mode button on the motion controller to initiate RTH. The aircraft will fly back to the last updated Home Point. During RTH, press the lock button once to cancel RTH. After exiting RTH, users will regain control of the aircraft.

Aircraft low battery

During flight, if the battery level is low and only sufficient to fly to the Home Point, a warning prompt will appear in DJI Fly or the goggles. If you confirm RTH or do not take action before the countdown ends, the aircraft will automatically initiate low battery RTH.

If you cancel the low battery RTH prompt and continue flying the aircraft, the aircraft will land automatically when the current battery level can only support the aircraft long enough to descend from its current altitude.

The remote control devices can be used to control the horizontal movement of the aircraft during the landing process. Fly the aircraft to a suitable place for landing as soon as possible.

-
- ⚠ • When the battery level is too low and there is not enough power to return home, land the aircraft as soon as possible. Otherwise, the aircraft will crash after the battery power runs out.
 - DO NOT keep pushing the throttle stick upward during auto landing. Otherwise, the aircraft will crash after the battery is completely depleted.
-

Loss of remote control or video transmission signal

When the remote control signal or video transmission signal is lost, the aircraft will automatically initiate Failsafe RTH if the Signal Lost Action is set to RTH.

The aircraft will fly backwards 20 m along its original flight route and then perform the RTH procedure. The aircraft will directly perform the RTH procedure if the signal is restored when flying backward along the original flight route.

RTH Procedure

After RTH is triggered, the aircraft brakes and hovers in place.

- If the RTH distance is farther than 20 m, it ascends to the RTH altitude and flies back to the Home Point. The aircraft flies to the Home Point at the current altitude if the current altitude is higher than the RTH altitude.
- If the RTH distance is farther than 5 m but less than 20 m, the aircraft adjusts its orientation and flies straight at the current altitude back to the Home Point.
- The aircraft lands immediately if the RTH distance is less than 5 m.

4.4 Auto Landing

In some situations, DJI Neo will land automatically with the landing protection function supported.

-
- ⚠ • DO NOT prevent DJI Neo from landing continuously due to a critical low battery. Otherwise, the battery will be damaged or DJI Neo will crash.
-

Trigger Method

In the following situations, DJI Neo will land automatically:

- DJI Neo reaches above the Home Point after RTH is triggered.
- DJI Neo has a critical low battery level.
- In Palm Control and Mobile App Control, positioning fails or DJI Neo detects a collision but does not crash.

Landing Protection

Landing Protection activates during auto landing

The specific actions of DJI Neo are as follows:

- If the ground is determined suitable for landing, DJI Neo will land directly.
- If the ground is determined unsuitable for landing, DJI Neo will hover and wait for pilot confirmation. You can perform palm landing or land DJI Neo manually.
- If DJI Neo fails to determine whether the ground environment is suitable for landing, DJI Fly or the goggles will display a landing prompt when DJI Neo descends to 0.3 m from the ground. Confirm the landing prompt and DJI Neo will land. You can also perform palm landing or land DJI Neo manually.



- Landing Protection only assists in determining the landing environment. Pay attention to the surrounding environment during landing to ensure safety.
- In the following situations, Landing Protection may be unavailable and DJI Neo may land directly on unsuitable ground:
 - Flying over monochrome, reflective, or low-light surfaces, a large area of surfaces without clear texture, or surfaces with dynamic texture, such as smooth ceramic tiles, garage floors with insufficient light, and grass blowing in the wind.
 - Flying over obstacles without clear texture, such as large rocks, or reflective or monochrome surfaces, such as raised tiles.
 - Flying over small or fine obstacles, such as power lines and tree branches.
 - Flying over surfaces that resemble flat ground, such as trimmed and flat shrubs, flat tree tops, and hemispherical ground.
- In the following situations, Landing Protection may be triggered by mistake and DJI Neo is unable to land. You can perform palm landing or land DJI Neo manually.
 - Flying over surfaces that the vision system may confuse for water, such as wet ground and areas with puddles.
 - Flying over flat surfaces, but there are surfaces with clear texture (oblique surfaces or stairs) nearby.

4.5 Vision System and Infrared Sensing System

DJI Neo is equipped with both an infrared sensing system and a downward vision system.

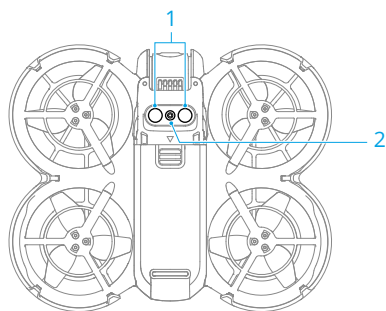

1. Infrared Sensing System
2. Downward Vision System

The effective operating environments for the vision system and infrared sensing system are as follows:

- Surfaces under the sensors are diffuse reflective surfaces with discernible patterns, diffuse reflectivity > 20% (such as concrete pavement).
- The lighting conditions are adequate (>15 lux but no more than 10,000 lux, normal indoor lighting conditions).

-
-  • Pay attention to the flight environment. The vision system and infrared sensing system only work in certain scenarios and cannot replace human control and judgment. During flight, always pay attention to the surrounding environment and to the warning prompts in DJI Fly or the goggles, and be responsible for and maintain control of DJI Neo at all times.
- The best positioning altitude range of the vision system is 0.5 to 10 m when using the vision system in an open environment with flat surfaces and clear textures. The vision positioning performance may decrease when flying beyond this range. Fly with caution.
 - The downward vision system may not work properly when flying near water. Therefore, DJI Neo may not be able to actively avoid water below it when landing. It is recommended to maintain flight control at all times, make reasonable judgments based on the surrounding environment, and avoid over-relying on the downward vision system.
 - The downward vision system and infrared sensing system may not function properly when DJI Neo is flying too fast or at an altitude that is too low.

- The vision system cannot work properly near surfaces without clear pattern variations or where the light is too bright or too dark. The vision system cannot work properly in the following situations:
 - Flying near monochrome surfaces (e.g., pure black, white, red, or green surfaces).
 - Flying over highly reflective surfaces (e.g., ice, glass, monochrome ceramic tiles).
 - Flying near water or transparent surfaces.
 - Flying near moving surfaces or objects.
 - Flying in an area with frequent and drastic lighting changes.
 - Flying near extremely dark (<15 lux) or bright (>10,000 lux) surfaces.
 - Flying near surfaces that strongly reflect or absorb infrared waves (e.g., mirrors).
 - Flying near surfaces without clear patterns or textures.
 - Flying near surfaces with repeating identical patterns or textures (e.g., tiles with the same design).
 - Flying near obstacles with small surface areas (e.g., tree branches and power lines).
 - Keep the sensors clean at all times. DO NOT scratch or tamper with the sensors. DO NOT use the device in dusty or humid environments.
 - DO NOT fly when it is rainy, smoggy, or the visibility is lower than 100 m.
 - DO NOT obstruct the infrared sensing system and vision system.
 - Check the following each time before takeoff:
 - Make sure there are no stickers or any other obstructions over the glass of the infrared sensing system or vision system.
 - Use a soft cloth if there is any dirt, dust, or water on the glass of the vision system and infrared sensing system. DO NOT use any cleaning product that contains alcohol.
 - Contact DJI Support if there is any damage to the lenses of the infrared sensing and vision system.
-

4.6 Propellers and Propeller Guards

DJI Neo comes with detachable propeller guards, which reduce damage to the propellers caused by collisions. It is required to remove the propeller guards on top of DJI Neo before removing or installing the propellers.

There are spare propellers in the box of DJI Neo. The packaging of the two propeller types are labelled with A and B respectively, together with the mounting position using illustrations. There are marks on the center of propeller A, while propeller B does not have any mark. Make sure to match the propellers and motors by following the instructions.

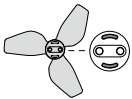
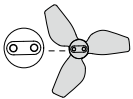
Propellers	Marked	Unmarked
Illustration		
Mounting Position	Attach to the motors of the marked arm	Attach to the motors of the unmarked arm

Removing and Installing

Propeller Guards

Make sure that DJI Neo is powered off. Remove the propeller guards by following the steps below.

1. Release the hooks on the propeller guards.
2. Push the propeller guard from the center.
3. Remove the other propeller guard in the same way.

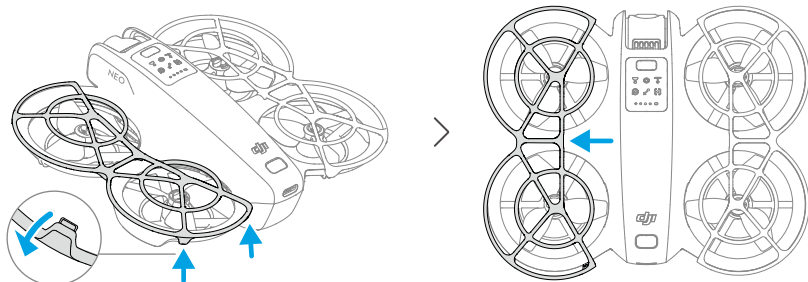

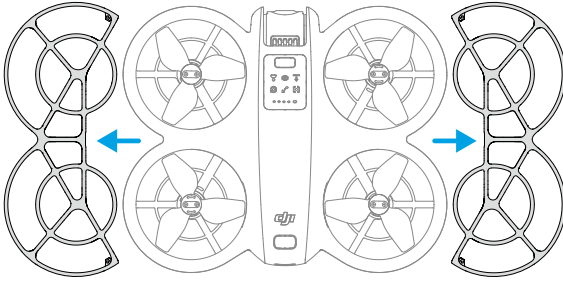

Install the propeller guard by following the steps below.

1. Push the propeller guard toward the body of DJI Neo until the middle hook snaps into position. Secure the other four hooks by pressing them from above into the holes of DJI Neo.

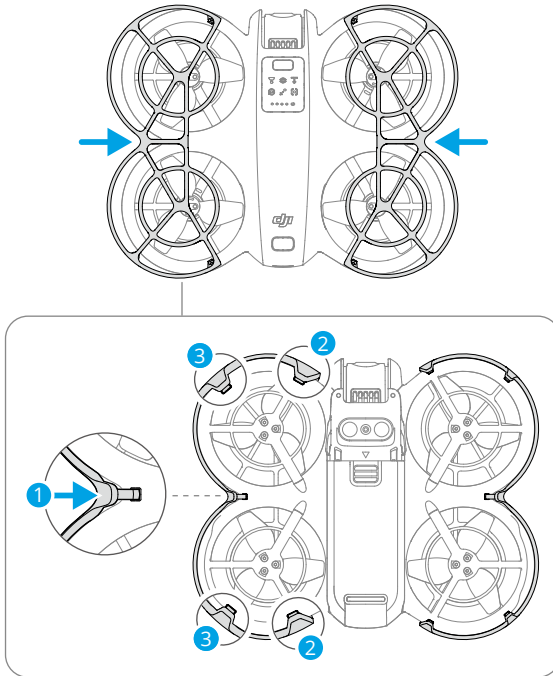

2. Install the other propeller guard in the same way.

Propellers

Use the screwdriver in the box of DJI Neo to install and remove the propellers. It is required to remove the propeller guards before installing and removing the propellers.

1. Use the screwdriver to remove the propellers from the motors.

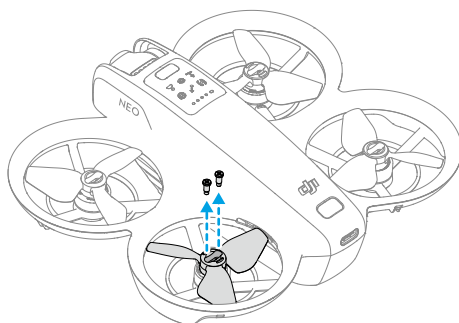

2. Install the marked propellers onto the motors of the marked arms and the unmarked propellers onto the motors of the unmarked arms. Use the screws provided in the packaging to secure the propellers. Make sure to tighten the screws.

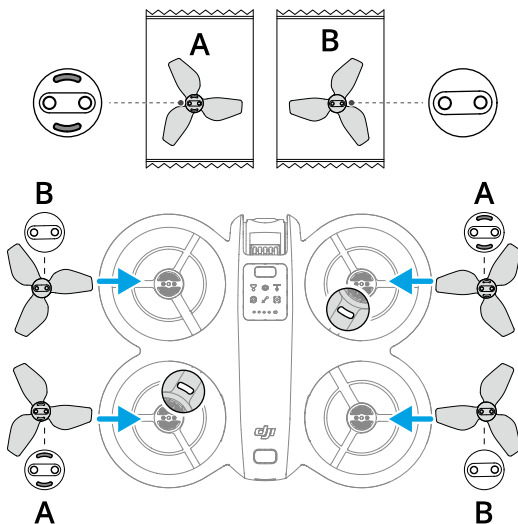

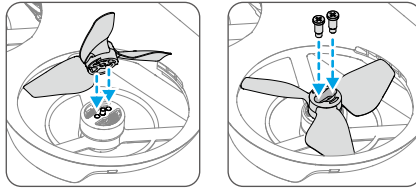

3. Reinstall the propeller guards after installing the propellers.

Notice

- ⚠ • DO NOT install or remove the propeller guard by force to avoid damage.
- Make sure to only use the screwdriver in the box of DJI Neo for installing and removing propellers. Using other screwdrivers may damage the screws.
- DO NOT use the screwdriver to disassemble DJI Neo.
- Make sure to keep the screws vertical while tightening them. The screws should not be at a tilted angle to the installation surface. After installation, check whether the screws are flush and rotate the propellers to check for any abnormal resistance.
- The propeller blades are sharp. Handle with care to avoid personal injury or propeller deformation.
- Make sure that the propellers and motors are installed securely before each flight. Make sure the screws on the propellers are tightened after every 15 hours of flying time (approx. 60 flights).
- If a propeller is broken, remove the propeller and screws on the corresponding motor and discard them.
- Only use official DJI propellers. DO NOT mix propeller types.
- Propellers are consumable components. Purchase additional propellers if necessary.
- Make sure that all propellers are in good condition and clean (without any foreign matter in or on them) before each flight. DO NOT use aged, chipped, or broken propellers. Clean the propellers with a soft, dry cloth if there is any foreign matter attached.
- To avoid injury, stay away from rotating propellers or motors.
- To avoid damaging the propellers, pack the DJI Neo correctly for transportation or storage. DO NOT squeeze or bend the propellers. If the propellers are damaged, the flight performance may be affected.

- Make sure the motors are mounted securely and rotating smoothly. Land DJI Neo immediately if a motor is stuck and unable to rotate freely.
 - DO NOT attempt to modify the structure of the motors.
 - DO NOT touch or let hands or body parts come in contact with the motors after flight, as they may be hot.
 - DO NOT block any of the ventilation holes on the motors or the body of DJI Neo.
 - Make sure the ESCs sound normal when DJI Neo is powered on.
-

4.7 Intelligent Flight Battery

DJI Neo uses the DJI Neo Intelligent Flight Battery, model BWX521-1435-7.3.*

* The battery chemical system is LiNiMnCoO₂.

Notice

-  • Read and strictly follow the instructions in this manual, in the *Safety Guidelines* and on the battery stickers before using the battery. You shall take full responsibility for all operations and usage.
-

1. DO NOT charge an Intelligent Flight Battery immediately after flight as it may be too hot. Wait for the battery to cool down to the allowable charging temperature before charging again.
2. To prevent damage, the battery only charges when the battery temperature is between 5° and 40° C (41° and 104° F). The ideal charging temperature is from 22° to 28° C (71.6° to 82.4° F). Charging at the ideal temperature range can prolong battery life. Charging stops automatically if the temperature of the battery cells exceed 55° C (131° F) during charging.
3. Low-Temperature Notice:
 - Batteries cannot be used in extremely low-temperature environments of lower than -10° C (14° F).
 - Battery capacity is significantly reduced when flying at low temperatures from -10° to 5° C (14° to 41° F). Make sure to fully charge the battery before takeoff. Hover the aircraft in place for a while to warm up the battery after takeoff.
 - It is recommended to warm up the battery to at least 10° C (50° F) before takeoff when flying in low-temperature environments. The ideal temperature to warm up the battery is above 20° C (68° F).

- The reduced battery capacity in low-temperature environments reduces the wind speed resistance performance of the aircraft. Fly with caution.
 - Take extra caution when flying at a high elevation with a low temperature.
4. A fully charged battery will automatically discharge when it is idle for a period of time. Note that it is normal for the battery to emit heat during the discharging process.
 5. Fully charge the battery at least once every three months to maintain battery health. If the battery is not used for an extended period, battery performance may be affected or may even cause permanent battery damage. If a battery has not been charged or discharged for three months or more, the battery will no longer be covered by the warranty.
 6. For safety purposes, keep the batteries at a low power level in transit. Before transportation, it is recommended to discharge the batteries to 30% or lower.

Inserting and Removing the Battery

Insert the Intelligent Flight Battery as shown below. Make sure to fully insert the battery until you hear a "click", which indicates the battery latch is securely fastened.

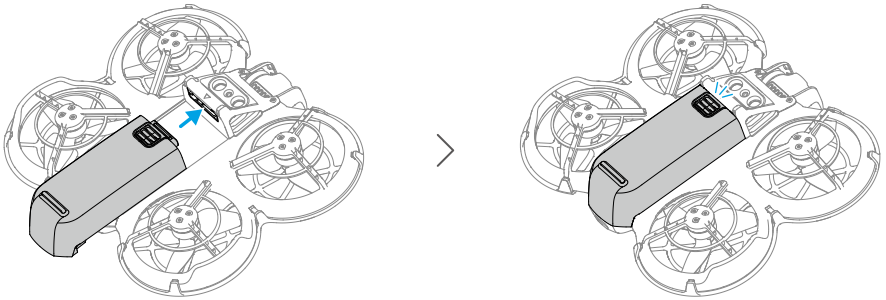

Press the textured part of the battery latch and push the battery to the rear of DJI Neo to remove it.

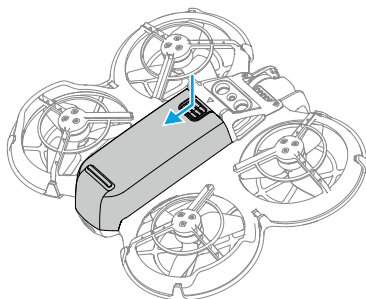

-
- ⚠ • DO NOT insert or remove the battery while the device is powered on.
- Make sure the battery is inserted with a "click". Otherwise, it may cause poor contact between the battery and DJI Neo after takeoff and present hazards.
-

Using the Battery

Checking the Battery Level

Press the power button once to check the current battery level.

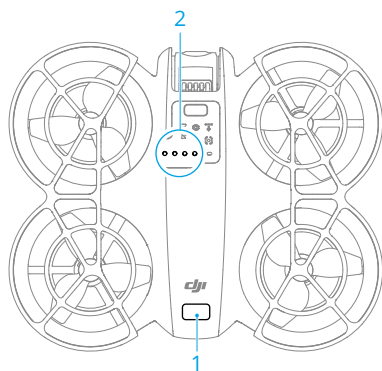

1. Power Button
2. Battery Level LEDs

The battery level LEDs display the power level of the battery during discharging. The statuses of the LEDs are defined below:

- LED is on
- ⚡ LEDs is flashing
- LED is off

Blinking Pattern	Battery Level
	88-100%
	76-87%
	63-75%
	51-62%
	38-50%
	26-37%
	13-25%
	0-12%

Powering On/Off

Press, then press and hold the power button on DJI Neo to power it on or off. The battery level LEDs display the battery level when is powered on. The battery level LEDs turn off when DJI Neo is powered off.

If the two LEDs shown in the picture below blink simultaneously, it indicates the battery is malfunctioning. Remove the battery from the device, insert the battery again and make sure that it is securely mounted.

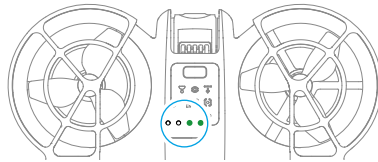

Updating the Firmware

If an additional battery needs to be updated, insert it into DJI Neo and power it on. A prompt will appear in DJI Fly to update the battery firmware. Make sure to update the battery firmware before takeoff. The table below shows battery information during the update process and corresponding LED blinking patterns.

Blinking Pattern	Information
	Updating battery firmware
	Firmware update failed

! If the update fails, reinsert the battery into DJI Neo and power on the device, and retry the firmware update using DJI Assistant 2 (Consumer Drones Series). Refer to the [Firmware Update](#) section in the Appendix for more information.

Charging the Battery

Fully charge the battery before each use. It is recommended to use the charging devices provided by DJI, such as the DJI Neo Two-Way Charging Hub, DJI 65W Portable Charger, or other USB Power Delivery chargers. The DJI Neo Two-Way Charging Hub and the DJI 65W Portable Charger are both optional accessories. Visit the official DJI online store for more information.

Using a Charger

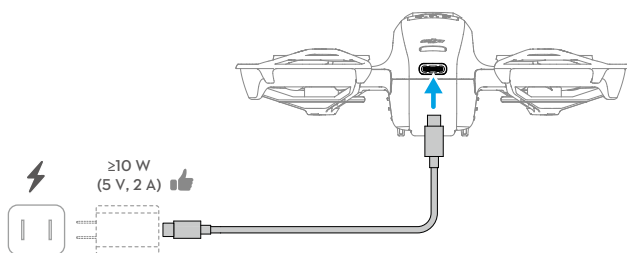

1. Make sure the battery has been securely installed in DJI Neo and is powered off.
2. Connect a charger to an AC power supply (100-240 V, 50/60 Hz; use a power adapter if necessary).
3. Connect the charger to the charging port on DJI Neo using a USB-C cable.
4. The battery level LEDs display the current battery level during charging.
5. The battery is fully charged when all the battery level LEDs emit a solid light. Remove the charger from DJI Neo when the battery is fully charged.

-
- ⚠ • The battery cannot be charged if the device is powered on.
 - The maximum charging power supported for the USB-C port on DJI Neo is 15 W.
-

The table below shows the battery level during charging.

Blinking Pattern	Battery Level
	0-50%
	51-75%
	76-99%
	100%



- Four LEDs blinking simultaneously indicates the battery is damaged.

Using the Charging Hub

When used with a USB charger, the DJI Neo Two-Way Charging Hub can charge up to three DJI Neo Intelligent Flight Batteries. When used with the DJI 65W Portable Charger, the charging hub can fully charge three Intelligent Flight Batteries in approximately 60 minutes.

Insert the Intelligent Flight Batteries into the charging hub and connect an external device to the USB port to charge the device, using the charging hub as a power bank. Refer to the *DJI Neo Two-Way Charging Hub User Guide* for more details.



- It is recommended to use a DJI 65W Portable Charger or other USB Power Delivery chargers to power the charging hub.
- The environmental temperature affects the charging speed. Charging is faster in a well-ventilated environment at 25° C (77° F).
- The charging hub is only compatible with BWX521-1435-7.3 Intelligent Flight Battery. DO NOT use the charging hub with other battery models.
- Place the charging hub on a flat and stable surface when in use. Make sure the device is properly insulated to prevent fire hazards.
- DO NOT touch the metal terminals on the battery ports. Clean the metal terminals with a clean, dry cloth if there is any noticeable buildup.
- Make sure to charge batteries with low battery power in time. It is recommended to store the batteries in the charging hub.

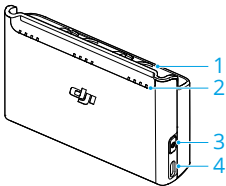

1. Battery Ports
2. Status LEDs (LED 1 to LED 4, from right to left in an array)
3. Function Button
4. USB-C Port

How to Charge

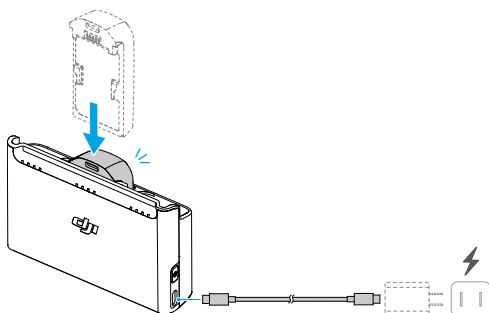

1. Insert the batteries into the battery ports of the charging hub until they click into place.
2. Connect the charging hub to a power outlet (100-240 V, 50/60 Hz) using a USB charger. The status LEDs indicate the battery status during charging. Refer to the Status LEDs Descriptions for more information about the blinking patterns.

The charging method varies depending on the power of the charger. Refer to the table below for details.

10 W ≤ Charger Power <30 W	Charges in sequence from highest to lowest battery level.
30 W ≤ Charger Power <45 W	Charges two batteries simultaneously: First charges the battery with a lower battery level to the same level as the highest one and then charges the two batteries simultaneously.
Charger Power ≥45 W	Charges three batteries simultaneously: First charges the two batteries with a lower battery level to the same level as the highest one and then charges the batteries simultaneously.

3. The batteries can be stored in the charging hub after charging.

Status LEDs Descriptions

Charging Status

Blinking Pattern	Descriptions
Status LEDs in an array blink quickly successively	The corresponding battery is being charged using a USB PD charger.
Status LEDs in an array blink slowly successively	The corresponding battery is being charged using a normal charger.

Blinking Pattern	Descriptions
Status LEDs in an array are solid	The corresponding battery is fully charged.
All status LEDs blink in sequence	No battery is inserted.

Battery Level







Each battery port has its corresponding status LED array, from LED1 to LED4 (right to left). Check the battery levels by pressing the function button once. The battery level LED statuses are the same as those on DJI Neo. For details, refer to the statuses and descriptions for battery level LEDs on DJI Neo in the [Using the Battery](#) section.

Abnormal Status

The LED status for battery abnormality is the same as that on DJI Neo. Refer to the Battery Protection Mechanisms section for details.

Battery Protection Mechanisms

The battery level LEDs can display battery protection notifications triggered by abnormal charging conditions.

LEDs	Blinking Pattern	Status
	LED2 blinks twice per second	Overcurrent detected
	LED2 blinks three times per second	Short circuit detected
	LED3 blinks twice per second	Overcharge detected
	LED3 blinks three times per second	Over-voltage charger detected
	LED4 blinks twice per second	Charging temperature is too low
	LED4 blinks three times per second	Charging temperature is too high

If any of the battery protection mechanisms are activated, unplug the charger, and plug it in again to resume charging. If the charging temperature is abnormal, wait for it to return to normal. The battery will automatically resume charging without the need to unplug and plug in the charger again.

4.8 Gimbal and Camera

Camera Notice

- ⚠ • DO NOT expose the camera lens to an environment with laser beams, such as a laser show, or point the camera at intense light sources for an extended period, such as the sun on a clear day, in order to avoid damaging the sensor.
 - Make sure the temperature and humidity are suitable for the camera during use and storage.
 - Use a lens cleaner to clean the lens to avoid damage or poor image quality.
 - DO NOT block any ventilation holes on the camera as the heat generated may damage the device or cause injury.
 - When using goggles with an 4:3 aspect ratio, footage recorded by DJI Neo is not stabilized, but supports offline stabilization with Gyroflow.
-

Gimbal Notice

- ⚠ • Remove the gimbal protector before powering on the device. Attach the gimbal protector when the device is not in use.
- Make sure there are no stickers or objects on the gimbal before taking off. Take off from a flat surface to protect the gimbal and make sure there are no other objects interfering the gimbal. DO NOT tap or knock the gimbal after the device is powered on.
- Precision components in the gimbal may be damaged by a collision or impact, which may cause the gimbal to function abnormally. Make sure to protect the gimbal from damage.
- Avoid getting dust or sand on the gimbal, especially in the gimbal motors.
- A gimbal motor may enter protection mode if the gimbal is obstructed by other objects when DJI Neo is put on uneven ground or on grass, or if the gimbal experiences an excessive external force, such as during a collision. Wait for the gimbal to recover or restart the device.
- DO NOT apply external force to the gimbal after the device is powered on.
- DO NOT add any extra payload other than an official accessory to the gimbal, as this may cause the gimbal to function abnormally or even lead to permanent motor damage.
- Flying in heavy fog or clouds may make the gimbal wet, leading to temporary failure. The gimbal will recover full functionality once it is dry.

- If there are strong winds, the gimbal may vibrate while recording.

Gimbal Angle

The gimbal has a control tilt range of -90° to $+60^{\circ}$. Use the remote control devices to control the tilt of the gimbal. Alternatively, do so through the camera view in DJI Fly.

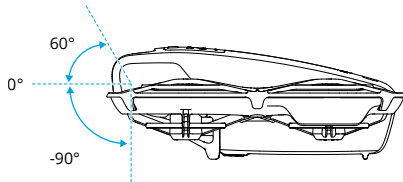

Gimbal Operation Modes

The gimbal mode will automatically switch according to the flight mode.

Normal/Sport/Cine mode: The gimbal is in attitude stabilization mode. The tilt angle of the gimbal remains stable relative to the horizontal plane, which is suitable for shooting stable images.

Manual mode: The gimbal is in lock mode. The tilt angle of the gimbal remains stable relative to the body of DJI Neo.

4.9 Storing and Exporting Photos and Videos

Storing

The aircraft comes with an internal storage. Photos and videos can be saved in the internal storage.

- ⚠️ • Check camera settings before use to ensure they are configured correctly.
- Before shooting important photos or videos, shoot a few images to test whether the camera is operating correctly.
- Make sure to power off the device correctly. Otherwise, the camera parameters will not be saved, and any recorded videos may be affected. DJI is not responsible for any loss caused by an image or video recorded in a way that is not machine-readable.

Exporting

- Use QuickTransfer to export the footage to a mobile device. Refer to the follow-up section for more information.
- Connect the aircraft to a computer using a data cable, export the footage in the internal storage of the aircraft. The aircraft does not need to be powered on during the exporting process.



4.10 QuickTransfer

DJI Neo can connect directly to a smartphone via Wi-Fi, enabling you to download photos and videos from DJI Neo to the smartphone.

In Mobile App Control, after the smartphone is connected to DJI Neo, enter QuickTransfer mode by going to the Album view.

When DJI Neo is not connected to the smartphone, you can tap the QuickTransfer or Wi-Fi Devices card on the home screen in DJI Fly to enter QuickTransfer mode. You can also go to Album in DJI Fly on your smartphone, and tap  in the upper right corner to enter QuickTransfer mode.

When connecting the smartphone to DJI Neo for the first time, press and hold the power button of DJI Neo to confirm.

-
-  • The maximum download rate can only be achieved in countries and regions where the 5.8 GHz frequency is permitted by laws and regulations, when using devices that support 5.8 GHz frequency band and Wi-Fi connection, and in an environment without interference or obstruction. If 5.8 GHz is not allowed by local regulations (such as in Japan), or your mobile device does not support the 5.8 GHz frequency band, or the environment has severe interference, then QuickTransfer will use the 2.4 GHz frequency band and its maximum download rate will reduce to 6 MB/s.
 - When using QuickTransfer, it is not necessary to enter the Wi-Fi password on the settings page of the mobile device in order to connect. Launch DJI Fly and a prompt will appear to connect the device.
 - Use QuickTransfer in an unobstructed environment with no interference and stay away from sources of interference such as wireless routers, Bluetooth speakers, or headphones.
-
-  • When viewing the album in QuickTransfer mode, ECO mode will be enabled automatically if the temperature of DJI Neo raises above a certain value. Pay attention to the prompt in the app.
-

DJI RC-N3

5 DJI RC-N3

DJI RC-N3 is equipped with the retractable mobile device holder, which can stably hold mobile devices while running the DJI Fly app.

5.1 Operations

Powering On/Off

Press the power button once to check the current battery level.

Press, then press and hold to power the remote controller on or off.

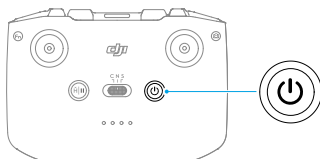

Charging the Battery

Connect the charger to the USB-C port on the remote controller.

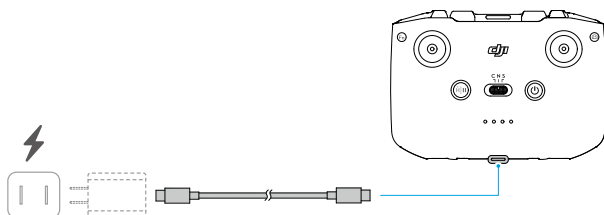

-
- ⚠ • Fully charge the remote controller before each flight. The remote controller sounds an alert when the battery level is low.
 - Fully charge the battery at least once every three months to maintain the battery's health.
-

Controlling the Gimbal and Camera

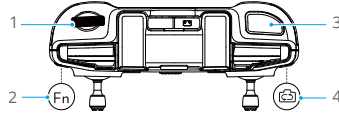

1. **Gimbal Dial:** Control the tilt of the gimbal.
2. **Customizable Button:** Press once to recenter the gimbal or point the gimbal downward by default.
3. **Shutter/Record Button:** Press once to take a photo or to start or stop recording.
4. **Photo/Video Button:** Press once to switch between photo and video mode.

Flight Mode Switch

Toggle the switch to select the desired flight mode.

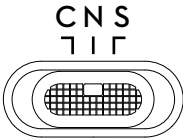

Position	Flight Mode
S	Sport Mode
N	Normal Mode
C	Cine Mode

Flight Pause/RTH Button

Press once to make the aircraft brake and hover in place.

Press and hold the button until the remote controller beeps and starts RTH. The aircraft will return to the last recorded Home Point. Press the button again to cancel RTH and regain control of the aircraft.

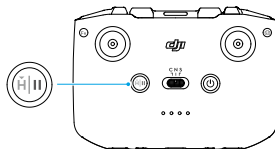

Customizable Button

Press the customizable button to recenter the gimbal or point the gimbal downward by default. To set the function, go to camera view in DJI Fly, and tap *** > Control > Button Customization.

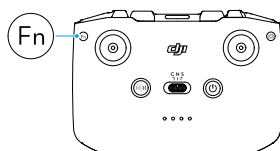

5.2 Battery Level LEDs

Blinking Pattern	Battery Level
● ● ● ●	76-100%
● ● ● ○	51-75%
● ● ○ ○	26-50%
● ○ ○ ○	0-25%

5.3 Remote Controller Alert

The remote controller sounds an alert during RTH, which cannot be cancelled. The remote controller sounds an alert when the battery level of the remote controller is low. A low battery level alert can be cancelled by pressing the power button. When the battery level is critically low, the alert cannot be cancelled.

There will be an alert if the remote controller is not used for a period while it is powered on but is not connected to the aircraft or the DJI Fly app on the mobile device. The remote controller will automatically power off after the alert stops. Move the control sticks or press any button to cancel the alert.

5.4 Optimal Transmission Zone

The signal between the aircraft and the remote controller is most reliable when the antennas are positioned in relation to the aircraft as illustrated below. If the signal is weak, adjust the remote controller orientation or antenna position, or fly the aircraft closer to the remote controller.

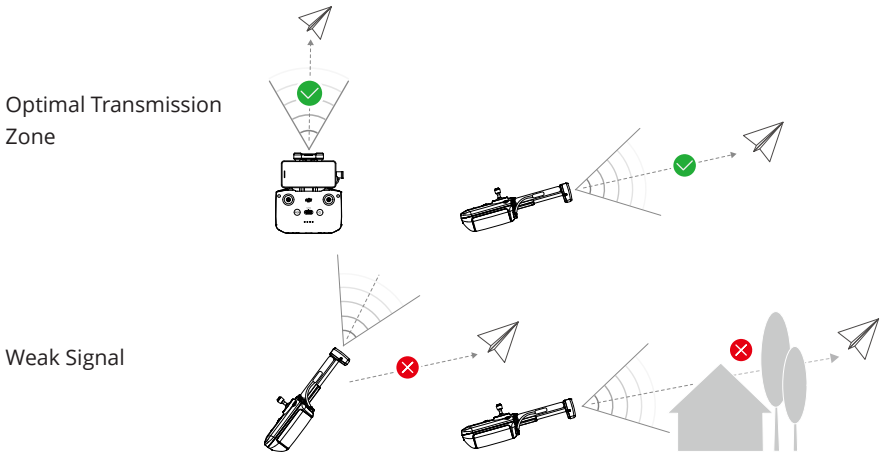

- ⚠ • DO NOT use other wireless devices operating at the same frequency as the remote controller. Otherwise, the remote controller will experience interference.
- A prompt will be displayed in DJI Fly if the transmission signal is weak during flight. Adjust the remote controller orientation according to the attitude indicator display to make sure that the aircraft is in the optimal transmission range.

5.5 Linking the Remote Controller

The remote controller is already linked to the aircraft when purchased together as a combo. Otherwise, follow the steps below to link the devices.

1. Power on the aircraft and the remote controller.
2. Launch DJI Fly.
3. In camera view, tap *** > **Control** > **Re-pair to Aircraft**. During linking, the remote controller beeps.
4. Press and hold the power button of the aircraft for more than four seconds. The aircraft beeps once, and its battery level LEDs blink in sequence to indicate it is ready to link. The remote controller will beep twice to indicate linking is successful.

- 💡 • Make sure the remote controller is within 0.5 m of the aircraft during linking.
- The remote controller will automatically unlink from an aircraft if a new remote controller is linked to the same aircraft.

- You can also start linking by following the method below. In the home screen of DJI Fly, tap **Connection Guide**, select aircraft model, and then select **Connect with RC Only**.
-

Appendix

6 Appendix

6.1 Specifications

Visit the following website for specifications.

<https://www.dji.com/neo/specs>

6.2 Compatibility

Visit the following website to get the information on compatible products.

<https://www.dji.com/neo/faq>

6.3 Firmware Update

Use DJI Fly or DJI Assistant 2 (Consumer Drones Series) to update the device.

Using DJI Fly

When using Mobile App Control, update the firmware according to the prompt on the home screen in DJI Fly. An internet connection is required during the firmware update.

When using the remote controller, connect the aircraft and remote controller, and run DJI Fly. You will be notified if a new firmware update is available. Follow the on-screen instructions to start the update. Note that you cannot update the firmware if the remote controller is not linked to the aircraft. An internet connection is required during the firmware update.

Using DJI Assistant 2 (Consumer Drones Series)

Use DJI Assistant 2 (Consumer Drones Series) to update all your devices separately.

1. Power on the device. Connect the device to a computer with a USB-C cable.
2. Launch DJI Assistant 2 (Consumer Drones Series) and log in with your DJI account.
3. Select the device and click **Firmware Update** on the left side of the screen.
4. Select the firmware version.
5. Wait for the firmware to download. The firmware update will start automatically. Wait for the firmware update to complete.

 • The battery firmware is included in DJI Neo firmware. Be sure to update all batteries.

- Make sure to follow all the steps to update the firmware, otherwise the update may fail.
- Make sure the computer is connected to the internet during the update.
- DO NOT unplug the USB-C cable during an update.
- Before performing an update, make sure that the device is at least 20% charged.
- The firmware update will take approximately 10 minutes. During the update process, it is normal for the gimbal to go limp, the status indicator to blink, and DJI Neo to reboot. Wait patiently for the update to complete.

Visit the following link and refer to the *Release Notes* for firmware update information:

<https://www.dji.com/neo/downloads>

6.4 Flight Recorder

Flight data including flight telemetry, aircraft status information, and other parameters are automatically saved to the internal data recorder of the aircraft. The data can be accessed using DJI Assistant 2 (Consumer Drones Series).

6.5 Post-Flight Checklist

- Make sure to perform a visual inspection so that the aircraft, remote controller, gimbal camera, Intelligent Flight Batteries, and propellers are in good condition. Contact DJI support if any damage is noticed.
- Make sure that the camera lens and vision system sensors are clean.
- Make sure to store aircraft correctly before transporting it.

6.6 Maintenance Instructions

To avoid serious injury to children and animals, observe the following rules:

1. Small parts, such as cables and straps, are dangerous if swallowed. Keep all parts out of reach of children and animals.
2. Store the Intelligent Flight Battery and remote controller in a cool, dry place away from direct sunlight to ensure the built-in LiPo battery does NOT overheat. Recommended storage temperature: between 22° and 28° C (71° and 82° F) for storage periods of more than three months. Never store in environments outside the temperature range of 14° to 113° F (-10° to 45° C).

3. DO NOT allow the camera to come into contact with or become immersed in water or other liquids. If it gets wet, wipe dry with a soft, absorbent cloth. Turning on an aircraft that has fallen in water may cause permanent component damage. DO NOT use substances containing alcohol, benzene, thinners, or other flammable substances to clean or maintain the camera. DO NOT store the camera in humid or dusty areas.
4. DO NOT connect this product to any USB interface older than version 3.0.
5. Check every aircraft part after any crash or serious impact. If there are any problems or questions, contact a DJI authorized dealer.
6. Regularly check the Battery Level Indicators to see the current battery level and overall battery life. The battery is rated for 200 cycles. It is not recommended to continue use afterward.
7. Make sure to transport the aircraft with the arms folded when powered off.
8. Make sure to transport the remote controller with antennas folded when powered off.
9. The battery will enter sleep mode during long-term storage. Charge the battery to exit from sleep mode.
10. Use the ND filter if the exposure time needs to be prolonged. Refer to the product information on how to install the ND filters.
11. Store the aircraft, remote controller, battery, and charger in a dry environment.
12. Remove the battery before servicing the aircraft (e.g., cleaning or attaching and detaching the propellers). Make sure that the aircraft and the propellers are clean by removing any dirt or dust with a soft cloth. Do not clean the aircraft with a wet cloth or use a cleanser that contains alcohol. Liquids can penetrate the aircraft housing, which can cause a short circuit and destroy the electronics.
13. Make sure to turn off the battery to replace or to check the propellers.

6.7 Troubleshooting Procedures

1. Why can the battery not be used before the first flight?

The battery must be activated by charging before using it for the first time.

2. How to solve the gimbal drift issue during flight?

Calibrate IMU and compass in DJI Fly. If the problem persists, contact DJI Support.

3. No function

Check if the Intelligent Flight battery and the remote controller are activated by charging. If the problems persist, contact DJI Support.

4. Power-on and start-up problems

Check if the battery has power. If yes, contact DJI Support if it cannot be started normally.

5. SW update issues

Follow the instructions in the user manual to update the firmware. If the firmware update fails, restart all the devices and try again. If the problem persists, contact DJI Support.

6. Procedures to reset to factory default or last known working configuration

Use the DJI Fly app to reset to factory default.

7. Shutdown and power-off problems

Contact DJI Support.

8. How to detect careless handling or storage in unsafe conditions

Contact DJI Support.

6.8 Risks and Warnings

When the aircraft detects a risk after powering on, there will be a warning prompt on DJI Fly. Pay attention to the list of situations below.

- If the location is not suitable for takeoff.
- If the location is not suitable for landing.
- If the compass and IMU experience interference and need to be calibrated.
- Follow the on-screen instructions when prompted.

6.9 Disposal



Observe the local regulations related to electronic devices when disposing of the aircraft and remote controller.

Battery Disposal

Dispose of the batteries in specific recycling containers only after a complete discharge. DO NOT dispose of the batteries in regular trash containers. Strictly follow the local regulations regarding the disposal and recycling of batteries.

Dispose of a battery immediately if it cannot be powered on after over-discharging.

If the power on/off button on the Intelligent Flight Battery is disabled and the battery cannot be fully discharged, contact a professional battery disposal/recycling agency for further assistance.

6.10 C0 Certification

DJI Neo is compliant with C0 certification requirements. There are some requirements and restrictions when using DJI Neo in EU member states and EFTA member states (EFTA, i.e. Norway, Iceland, Liechtenstein, Switzerland).

UAS Class	C0
Maximum Propeller Speed	36570 RPM

MTOM Statement

The MTOM of DJI Neo (Model DN1A0626) is 135 g to comply with C0 requirements.

You must follow the instructions below to comply with the MTOM C0 requirements.

Otherwise, the aircraft cannot be used as a C0 UAV:

- DO NOT add any payload to the aircraft except the items listed in the List of Items including qualified accessories section.
- DO NOT use any non-qualified replacement parts, such as intelligent flight batteries or propellers, etc.
- DO NOT retrofit the aircraft.

List of Items, including qualified accessories

1. DJI Neo Propeller (Pair) (Model: 2016S1, 5.3 g)
2. DJI Neo Propeller Guard (Pair) (Model: 2016PG, 5.3 g)
3. DJI Neo Intelligent Flight Battery (Model: BWX521-1435-7.3, Approx. 45 g)

List of Spare and Replacement Parts

1. DJI Neo Propeller (Pair) (Model: 2016S1, 5.3 g)
2. DJI Neo Propeller Guard (Pair) (Model: 2016PG, 5.3 g)
3. DJI Neo Intelligent Flight Battery (Model: BWX521-1435-7.3, Approx. 45 g)

Direct Remote ID

- Transport Method: Wi-Fi Beacon.

- Method of uploading the UAS Operator Registration Number to the aircraft: Enter DJI Fly, tap *** > **Safety** > **UAS Remote Identification**, and then upload UAS operator registration number.

Remote Controller Warnings

DJI RC-N3

The battery level LEDs will start blinking slowly after disconnecting from the aircraft. The remote controller will beep and power off automatically after disconnecting from the aircraft and with no operation for a long time.

-
- ⚠ • Avoid interference between the remote controller and other wireless equipment. Make sure to turn off the Wi-Fi on nearby mobile devices. Land the aircraft as soon as possible if there is interference.
 - Release the control sticks or press the flight pause button if an unexpected operation occurs.
-

GEO Awareness

GEO Awareness contains the features listed below.

UGZ (Unmanned Geographical Zone) Data update: You can update the FlySafe data by using the data update feature automatically or storing the data in the aircraft manually.

- Method 1: Go to Settings in DJI Fly and tap **About** > **FlySafe Data** > **Check for Updates** to update the FlySafe data automatically.
- Method 2: Check the website of your national aviation authority regularly and obtain latest UGZ data to import to your aircraft. Go to Settings in DJI Fly, tap **About** > **FlySafe Data** > **Import from Files**, and then follow the on-screen instructions to store and import the UGZ data manually.

-
- 🔔 • A prompt will appear in the DJI Fly app when the import completes successfully. If the import fails due to improper data format, follow the on-screen prompt and retry.

-
- ⚠ • Before takeoff, users must download the latest GEO Zone data from the official aviation regulation website of the country or region where the aircraft is being used. It is the responsibility of the user to make sure that the GEO zone data is the latest version and that it is applied to every flight.
-

GEO Awareness Map Drawing: After the latest UGZ data is updated, a flight map with a restricted zone will be displayed in the DJI Fly app. Name, effective time, height limit, etc., can be viewed by tapping the related area.

GEO Awareness Pre-Warning: The app will prompt you with warning information when the aircraft is near or in a restricted area to remind you to fly with caution.

AGL (Above Ground Level) Statement

The vertical part of Geo-Awareness may use the AMSL altitude or the AGL height. The choice between these two references is specified individually for each UGZ. Neither AMSL altitude nor the AGL height is supported by DJI Neo. The height H appears in the DJI Fly app camera view, which is the height from the aircraft takeoff point to the aircraft. The height above the takeoff point may be used as an approximation but may differ more or less from the given altitude/height for a specific UGZ. The remote pilot remains responsible for not breaching the vertical limits of the UGZ.

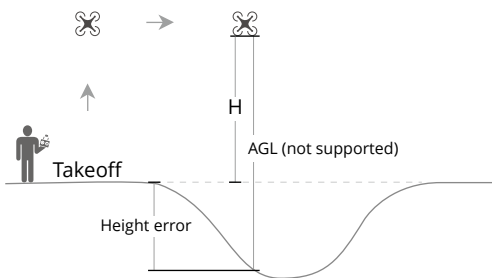

Restricted Zones

Appear red in the DJI app. You will be prompted with a warning, and flight is prevented. UA cannot fly or take off in these zones. Restricted Zones may be unlocked, to unlock contact flysafe@dji.com or go to Unlock A Zone at dji.com/flysafe.

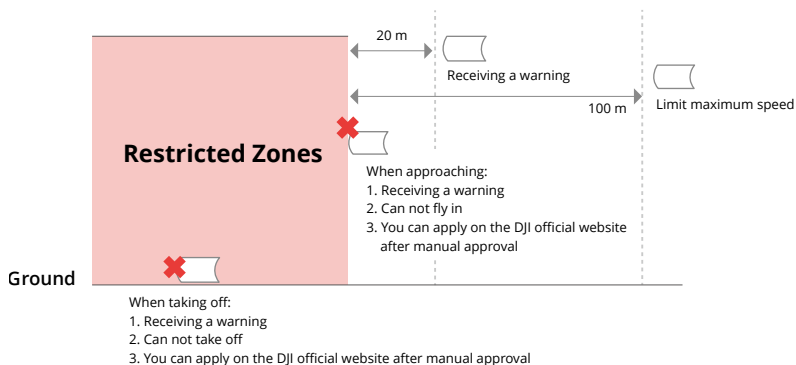

Authorization Zones

Appear blue in the DJI app. You will be prompted with a warning, and flight is limited by default. UA cannot fly or take off in these zones unless authorized. Authorization Zones may be unlocked by authorized users using a DJI verified account.

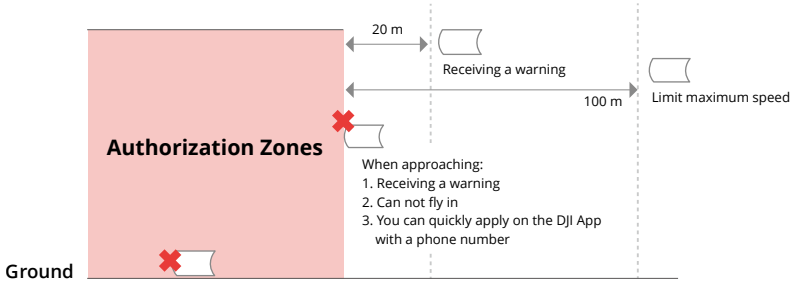

Altitude Zones

Altitude zones are zones with a limited altitude and appear in gray on the map. When approaching, you will receive a warning in the DJI app.

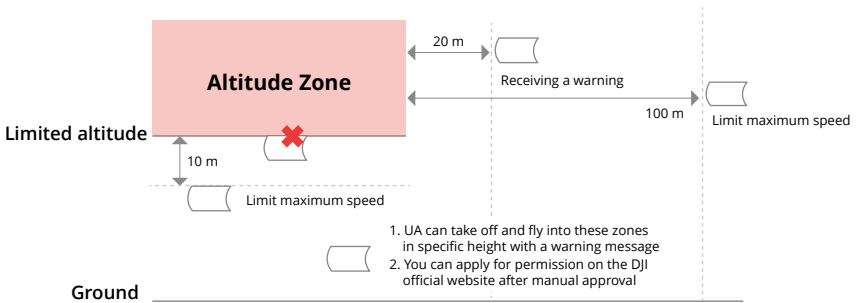

Enhanced Warning Zones

A warning message will appear when the drone reaches the edge of the zone.



Warning Zones

A warning message will prompt you when the drone reaches the edge of the zone.



-
- ⚠ • When the aircraft and DJI Fly app cannot obtain a GPS signal, the GEO awareness function will be inoperative. Interference of the aircraft antenna or disabling the GPS authorization in DJI Fly will cause the GPS signal fails to be obtained.
-

EASA Notice

Make sure to read the Drone Information Notices document included in the package before use.

Visit the link below for more EASA notice information on traceability.

<https://www.easa.europa.eu/en/document-library/general-publications/drones-information-notice>

Original Instructions

This manual is provided by SZ DJI Technology, Inc., and the content is subject to change.

Address: Lobby of T2, DJI Sky City, No. 53 Xianyuan Road, Xili Community, Xili Street, Nanshan District, Shenzhen, China, 518055.

6.11 Aftersales Information

Visit <https://www.dji.com/support> to learn more about aftersales service policies, repair services, and support.

WE ARE HERE FOR YOU



Contact

DJI SUPPORT

This content is subject to change without notice.

Download the latest version from



<https://www.dji.com/neo/downloads>

If you have any questions about this document, please contact DJI by sending a message to **DocSupport@dji.com**.

DJI and DJI NEO are trademarks of DJI.

Copyright © 2024 DJI All Rights Reserved.