



Perfect Appearance Excellent Performance

精 于 静 精 于 动

P-51 D Mustang **V8**

OPERATING MANUAL



<http://www.facebook.com/FMSmodel>



www.fmsmodel.com

Please visit both our **Facebook** fanpage and our homepage for updated product information

WARNING

 **WARNING:** Read the ENTIRE instruction manual to become familiar with the features of the product before operating. Failure to operate the product correctly can result in damage to the product, personal property and cause serious injury.

This is a sophisticated hobby product and NOT a toy. It must be operated with caution and common sense and requires some basic mechanical ability. Failure to operate this Product in a safe and responsible manner could result in injury or damage to the product or other property. This product is not intended for use by children without direct adult supervision.

This manual contains instructions for safety, operation and maintenance. It is essential to read and follow all the instructions and warnings in manual, prior to assembly, setup or use, in order to operate correctly and avoid damage or serious injury.

Safety Precautions and Warnings

As the user of this product, you are solely responsible for operating in a manner that does not endanger yourself and others or result in damage to the product or the property of others. This model is controlled by a radio signal subject to interference from many sources outside your control. This interference can cause momentary loss of control so it is advisable to always keep a safe distance in all directions around your model, as this margin will help avoid collisions or injury.

Age Recommendation: Not for children under 14 years. This is not a toy.

- Never operate your model with low transmitter batteries.
- Always operate your model in an open area away from cars, traffic or people.
- Avoid operating your model in the street where injury or damage can occur.
- Never operate the model in the street or in populated areas for any reason.
- Carefully follow the directions and warnings for this and any optional support equipment (chargers, rechargeable battery packs, etc.) you use.
- Keep all chemicals, small parts and anything electrical out of the reach of children.
- Moisture causes damage to electronics. Avoid water exposure to all equipment not specifically designed and protected for this purpose.
- Never lick or place any portion of your model in your mouth as it could cause serious injury or even death.



Table of Contents

Safety.....	4
Introduction and History.....	4
Contents of Kit.....	5
Additional Required Items.....	6
Assembly Instructions.....	6
Generic Binding Instructions.....	17
ESC Information.....	18
Control Surfaces.....	18
Final Assembly, Detailing, and Propeller Set.....	21
Center of Gravity.....	27
Pre-flight Checklist.....	27
Flight Safety.....	27
Daily Flight Checks.....	28
Maiden Flight Tips.....	28
Routine Maintenance.....	29
Troubleshooting Guide.....	29
Customer Support and Spare Parts Contact Information.....	29
Spare Parts List.....	29
AMA Safety Code.....	33

Safety

Lithium Polymer (Li-Po) Battery Warning

CAUTION: Always follow the manufacturer's instructions for safe use and disposal of batteries. Fire, property damage, or serious injury can result from the mishandling of Li-Po Batteries.

- By handling, charging or using a Li-Po Battery you assume all risks associated with lithium batteries.
- If at any time the batteries begin to swell, or balloon, discontinue use immediately! Charging or discharging a swelling or ballooning battery can result in fire.
- Always store the batteries at room temperature in a dry area to extend the life of the battery. Always transport or temporarily store the battery in a temperature range of 40-120F. Do not store the battery or model in a car or in direct sunlight. If stored in a hot car, the battery can be damaged or even catch fire.
- Never use a Ni-Mh Charger to charge Li-Po Batteries. Failure to charge the battery with a Li-Po compatible charger may cause fire resulting in personal injury and property damage.
- Never discharge Li-Po Cells below 3V.
- Never leave charging batteries unattended.
- Never charge damaged batteries.

Charging the Flight Battery Warning

- Use a battery charger that is designed to safely charge the Li-Po Battery. Read the charger instructions carefully before use. When charging the battery, make certain the battery is on a heat resistant surface. It is also highly recommended to place the Li-Po Battery inside a fire resistant charging bag readily available at hobby shops or online.

Introduction and History

The P-51 Mustang was originally designed and built by North American Aviation to fulfill a British requirement for fighter service in Europe during the early stages of World War II, but eventually became the leading US fighter in Europe during the final months of the war. The P-51 was the first fighter to have a laminar flow wing design to reduce drag and thereby increase speed and range. Drag was further reduced by the placement of a ventral radiator underneath the rear of the fuselage to present the smallest possible fuselage cross section.

The P-51D had several improvements from the original P-51 which included the tear drop canopy, six .50 caliber machine guns, provisions for rocket launchers, dorsal fins, and a Merlin V-1650-7 capable of producing 1,695 hp which provided a speed of 437 mph at 25,000 feet.

Many consider the Mustang to be the best piston aircraft of World War II. Mustangs were the highest scoring US fighter in European operations destroying 4,950 enemy aircraft. A total of 14,819 Mustangs were built for the USAAF and were used as interceptors, bomber escorts, dive bombers, ground attackers, trainers, and for reconnaissance. Mustangs also provided service in the Korean War. Following the wars, Mustangs have been used by some as high performance racers.

Contents of Kit

Before assembly, please inspect the contents of the kit. The two photos below detail the contents of the kit and label the major pieces "A" thru "P" for your convenience. If any parts are missing or defective, please identify the name or part number (refer to the spare parts list near the end of the manual), then contact the FMS Team.

FMS Team Product Support

3/F, Building B, 3rd Industry Zone, Matigang, Dalingshan Town,
Dongguan City, P.R.C.

Phone: 0086-769-86976655

Email: info@fmsmodel.com

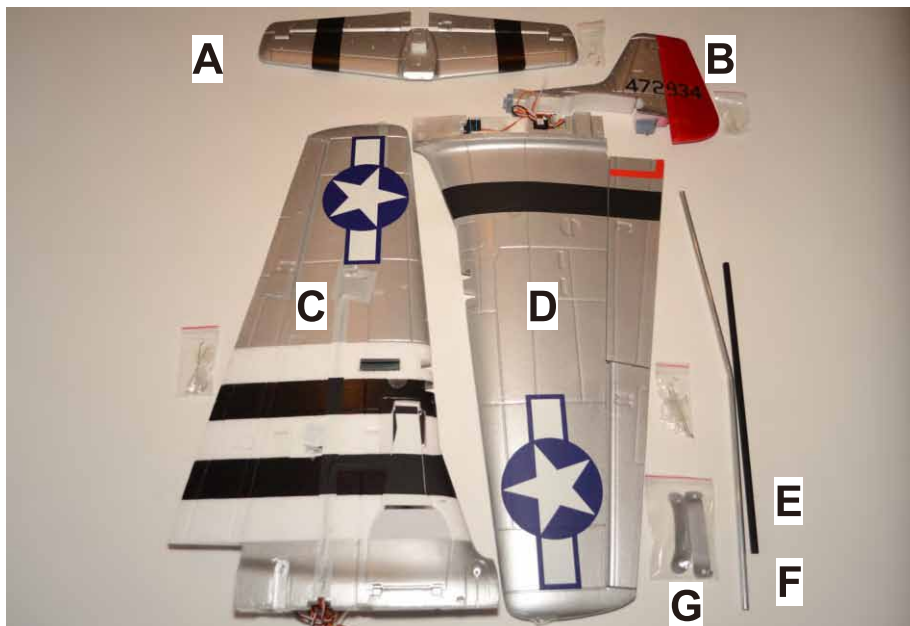

Additional Required Items

Tools and Adhesives

- Glue Brush
- Tape
- Marking Pen
- Tape Measure

Transmitter/Receiver (required for PNP and kit version)

This model requires a 6 channel receiver and transmitter.

Battery/Charger (required for PNP and kit version)

A 14.8V 2600 mAh 25C Li-Po Battery is recommended. If using another battery, it must be at least a 14.8V 2600mAh 25C battery, approximately the same capacity, dimensions, and weight to fit in the fuselage without changing the center of gravity significantly. A standard Li-Po Battery Balancing Charger is required to safely charge the battery. Caution: A 5S (18.5V) Li-Po Battery exceeds the maximum capacity of the ESC and motor and will result in ESC failure during flight. This would cause a complete loss of control creating a potentially dangerous condition. Do not use a 5S (18.5V) or larger battery in this product.

Motor/ESC/Servos/Propeller (required for kit version only)

The kit version requires a Brushless 4250-KV540 motor, a 70A ESC with 5A SBEC, (6) 9g servos, (3) 17g servos, and a 14x8 four blade propeller.

Assembly Instructions

The assembly instructions in this manual have been divided into logical steps. Check boxes have been placed in front of each step to help you keep track of your progress. Please read each step carefully, perform the task per the instructions, and mark when completed. If you are unavoidably interrupted before completing a step, it is advisable to make a detailed notation of any unfinished items to ensure the step is fully completed when you return to the task. Refer to the “Contents of Kit” photos if you need help identifying a part.

Install the control horns

- 1) Locate the horizontal stabilizer “A” and a parts bag labeled “Elevator” which contains the elevator control horn, backing plate, and screws (fig. 1).
- 2) Install the elevator control horn on the bottom surface of the elevator, with the horn pointing towards the hinge line of the horizontal stabilizer (fig. 2). Push the control horn backing plate onto the top side of the elevator surface, embedding the raised surface into the foam. Using the provided screws, secure the control horn from the horn side. Note: The longer screws are always used on the leading edge side of the surface which is thicker.

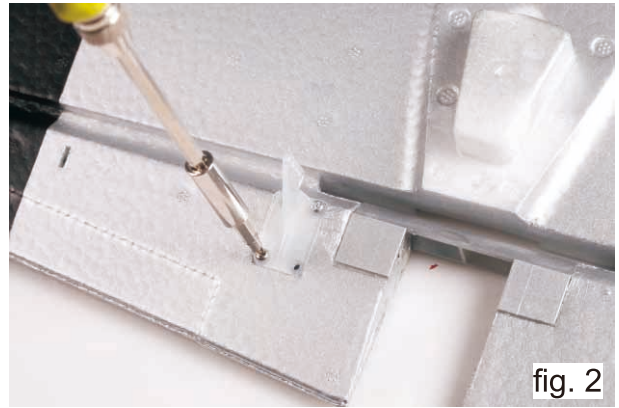

- 3) Verify the screws fully engage the backing plate (fig. 3). Note: Do not over-tighten the screws, but ensure the control horn and back plate are snug against the elevator surface.
- 4) Locate the vertical stabilizer “B” and a parts bag labeled “Rudder” which contains the rudder control horn, backing plate, and screws. Install the rudder control horn on the left side of the rudder with the horn pointing towards the hinge line of the vertical stabilizer as shown (fig. 4). Follow the same process that was used in steps 2 and 3.



- 5) Locate the wing panels “C” and “D” and a parts bag labeled “Aileron” that contains the aileron control horn parts and linkage rods. Install the control horns for the ailerons in the same manner as the elevator control horn with the horns on the underside and towards the hinge line of the wing control surfaces (fig. 5).
- 6) Locate a parts bag labeled “Flap” that contains the flaps control horn parts and linkage rods. Install the control horns for the flaps in the same manner as the elevator control horn with the horns on the underside and towards the hinge line of the wing control surfaces (fig. 6).



fig. 5

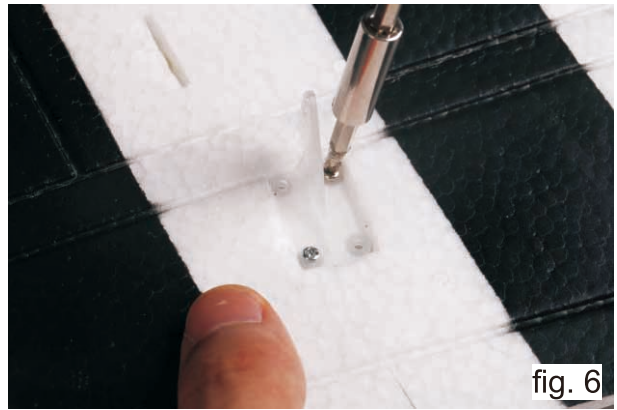

fig. 6

Install the control rod linkages

- 7) Using the linkage rods from parts bag “Aileron” for the ailerons and the linkage rods from parts bag “Flap” for the flaps, put the Z-bend end of the linkage into the third hole from the center screw on each servo control horn (fig. 7). Insert the Z-bend thru the hole in the proper direction to keep the linkage in straight alignment with the surface control horn. Ensure the fit is not tight enough to cause binding during movement. Adjust fit as needed. Note: Slide a piece of the supplied fuel tubing over the linkage rod prior to putting the linkage into the servo hole. This will make step 9 easier to perform.
- 8) Snap the clevis into the desired hole in the surface control horn for the ailerons and flaps. For a single rate transmitter use the first hole to achieve a lower rate setting (fig. 8). Use the fourth hole nearest the control surface to achieve a higher rate setting.



fig. 7

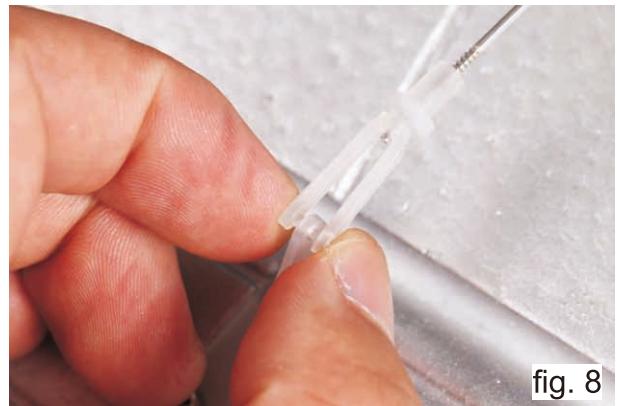

fig. 8

- 9) The provided piece of fuel tubing keeps the clevis securely closed during flight operations. Slide the tubing onto the clevis. Secure all linkages in the same manner (fig. 9). Do not allow the fuel tubing to interfere with control movements by pushing the tubing too far onto the clevis (fig.10).



fig. 9



fig.10

Build the Wing

- 10) Insert the fiberglass connecting tube “E” into the wing trailing edge side socket until it is approximately half way in. Stop when you reach the white mark on the tube. Do not force it farther than it will slide. This will push the tube into the foam of the wing and prevent it from fully inserting into the opposite wing panel (fig. 11). Note: If the tube is not marked, use a tape measure to determine the center of the tube and a marking pen or a piece of tape to temporarily mark it so you don't insert it too far.
- 11) Insert the pre-bent Aluminum connecting tube “F” into the wing leading edge side socket until you reach the bend (fig. 12).



fig.11

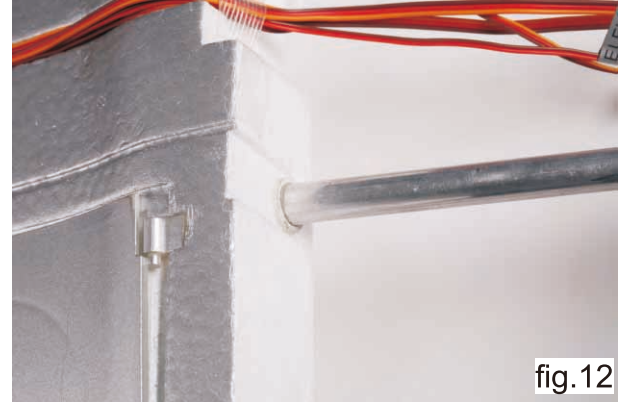

fig.12

- 12) From the top view the two connecting rods should be parallel. Ensure that Aluminum rod is rotated such that the pre-bent angle is consistent with the dihedral of the wing (fig. 13).
- 13) Insert the connecting tubes into the other wing half. Slide the wing halves together. Make sure the wing halves come together completely. If not, you must find and remove the obstruction (fig. 14).

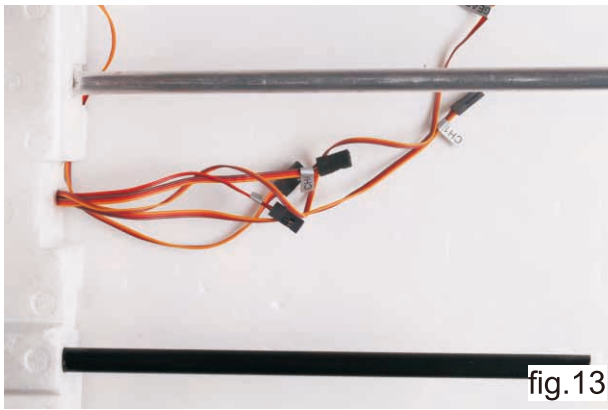

fig.13

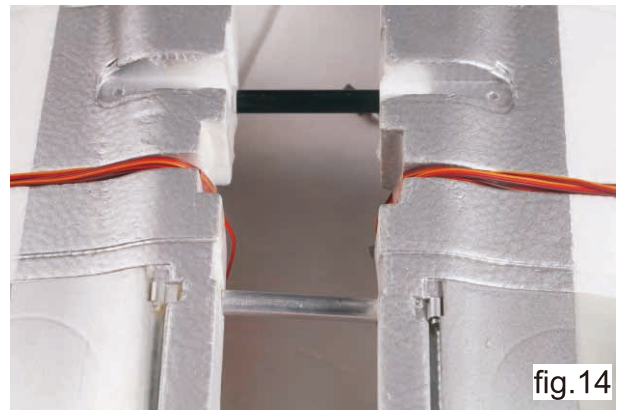

fig.14

- 14) Use a small amount of glue and distribute it evenly in the pocket for the rear bolt plate. A glue brush is recommended for this process (fig. 15 & 16).



fig.15

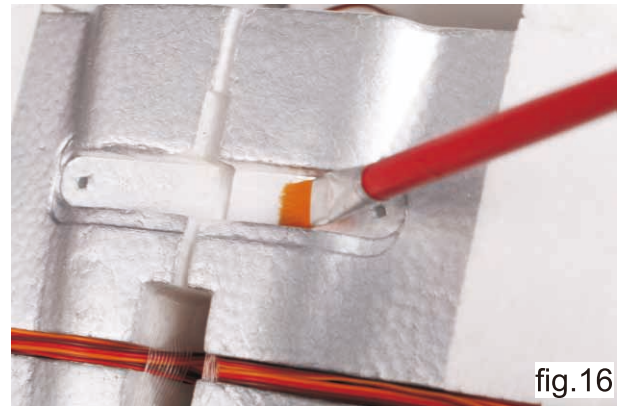

fig.16

- 15) Locate the wing bolt plates “G”. Place the rear bolt plate into the notch. The plate only fits correctly in one direction (fig. 17).
- 16) Repeat the same gluing process for the front bolt plate. It only fits correctly in one direction (fig. 18).

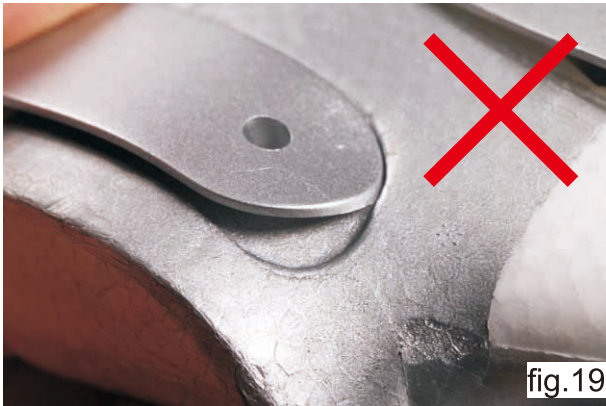

fig.17

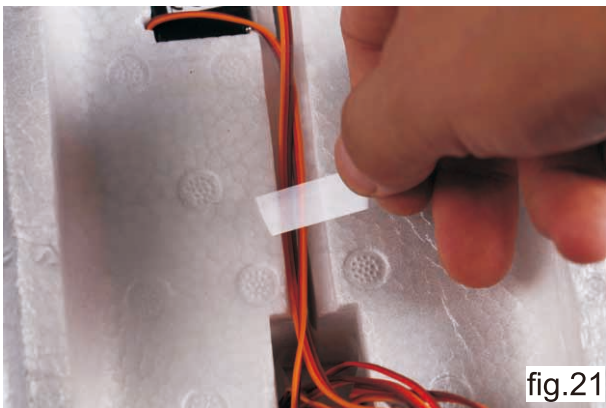

fig.18

- 17) If you attempt to install one of the mounting plates in the wrong direction, it will not seat correctly in the pocket (fig. 19).
- 18) Place the two inner fairing door servo leads into the slot between the two wing panels along with the other leads (fig. 20).



- 19) Secure the servo leads in the slot with clear tape or glass fiber tape (fig. 21)



Install the Stabilizer

- 20) Insert the nose of the horizontal stabilizer "A" into the slot in the tail end of the fuselage "H" (fig. 22). Make sure it is fully seated (fig. 23).
- 21) Secure the trailing edge side of the stabilizer using the provided screw (PA 2.6 x 25mm). Do not over tighten the screw (fig. 24). There is another screw on the leading edge side of the stabilizer. Do not install the leading edge side screw at this time. It will be secured during a later assembly step.

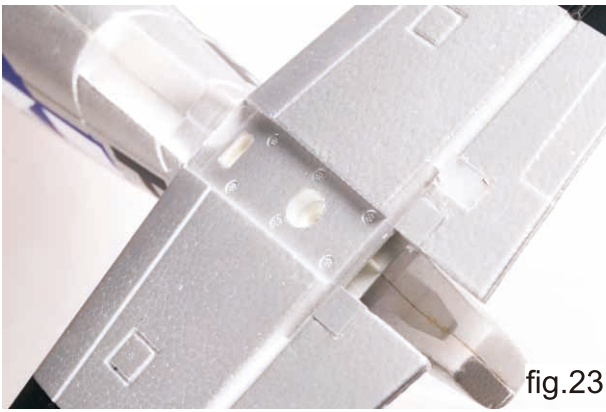

fig.23



fig.24

- 22) Insert the vertical stabilizer “B” into the slot in the fuselage (fig.25).
- 23) Raise the elevator to the full up position. Insert the dowel pin on the bottom of the vertical stabilizer into the corresponding notch in the fuselage (fig. 26).



fig.25

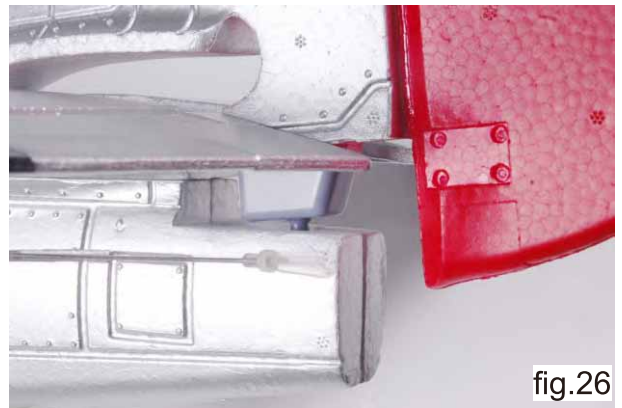

fig.26

- 24) Slide the vertical stabilizer forward inserting the dowel pins into the corresponding notch in the fuselage. Ensure the stabilizer is fully seated (fig. 27).
- 25) Secure the vertical stabilizer by installing the provided self tapping screw (PA 2.6x25mm) from the underside of the fuselage (fig. 28).



fig.27



fig.28

Mount the Wing

- 26) Locate the left and right wing filler pieces “1” (fig. 29).
- 27) Test fit the wing filler pieces to determine the correct orientation. If the filler is installed into the notch in the wrong orientation it will not fit correctly (fig. 30).



- 28) Once the correct filler piece orientation is determined, remove the filler piece and apply glue where it will fit against the fuselage (fig. 31).
- 29) Press the filler piece into place quickly before the glue begins to dry (fig. 32). Repeat the process for the other filler piece.

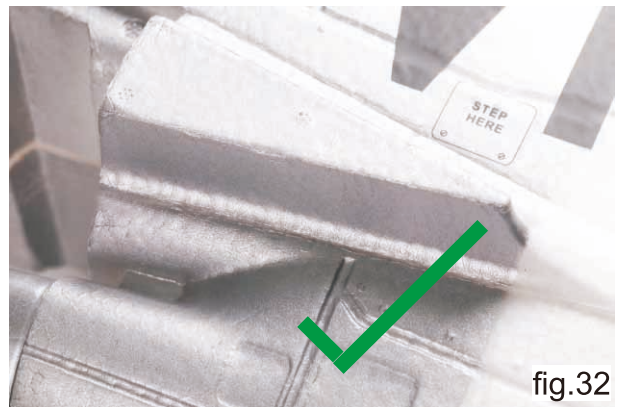

- 30) Mount the wing to the fuselage by fitting the rear side of the wing to groove under the air cooling intake vent (fig. 33). Note: For the kit version, steps 38, 39 & 40 must be completed prior to installing the wing. In the PNP version of this model, some of the wiring comes pre-connected.
- 31) Guide the cables from the wing panels thru the hole in the bottom of the fuselage wing bay (fig. 34).

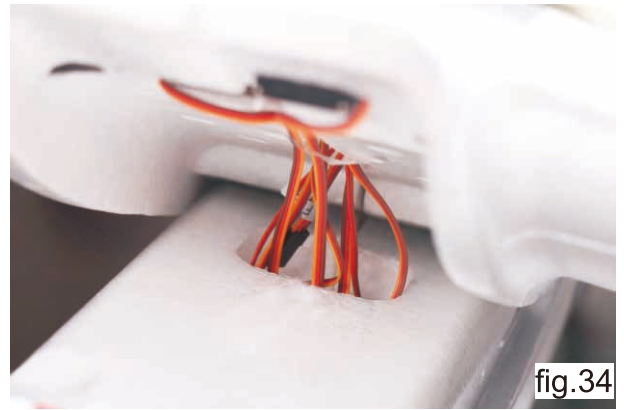

- 32) Put the wing into place and gently pull the cables from inside of the canopy simultaneously to avoid any tangling of the cables (fig. 35).
- 33) Secure the rear wing bolt plate using the provided machine screws (PM 3.0x60mm) (fig. 36).

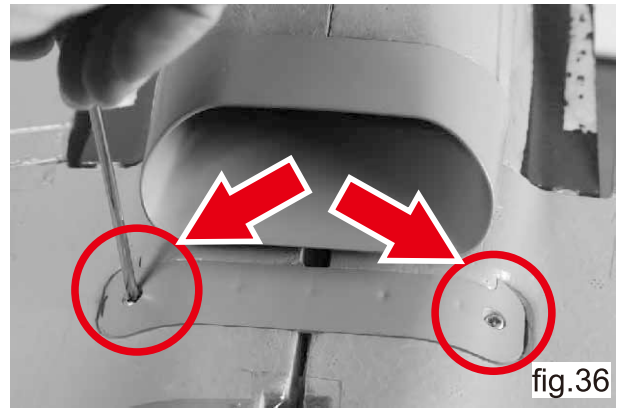

- 34) Secure the front wing bolt plate using the provided machine screws (PM 3.0x45mm) (fig. 37).

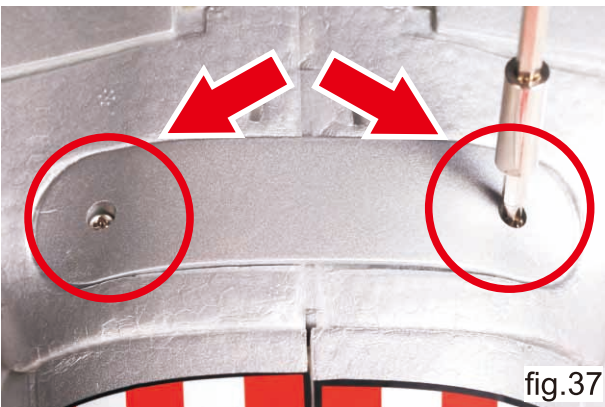

Install the Propeller Blades to the backplate

- 35) Locate parts group “J” which contains the propeller and the spinner kit (fig. 38).
- 36) Place two self locking nuts into the hex shaped pockets on the back side of the spinner backplate (fig. 39).



- 37) Use a flat piece of laminated board, plastic, or metal to hold the nuts in their pockets when you flip the backplate over to install the propeller blade (fig. 40).
- 38) Take one of the propeller blades and fit it into the corresponding notch on the front side of the spinner backplate. The painted side of the propeller should be facing forward. Attach the blade to the spinner backplate with two machine screws (PM 3.0x18mm) (fig. 41).



- 33) Repeat the same process for the other three propeller blades (fig. 42).



Receiver Connection

- 38) Connect the servo and retract leads per the photos and the receiver connection diagram (fig. 43 thru fig. 47). All leads have been labeled for your convenience.

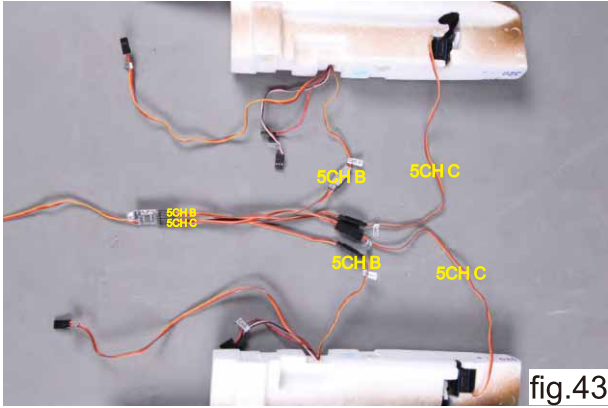

fig.43

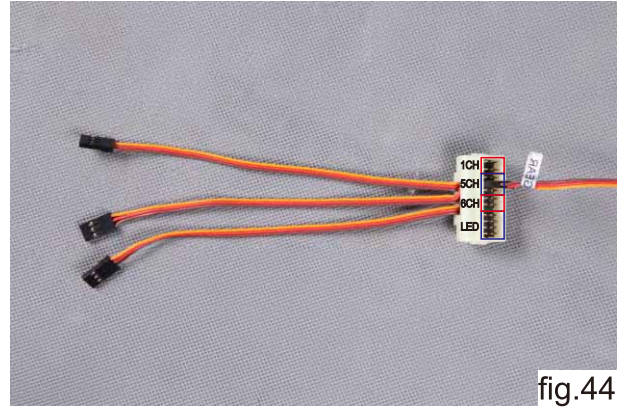

fig.44

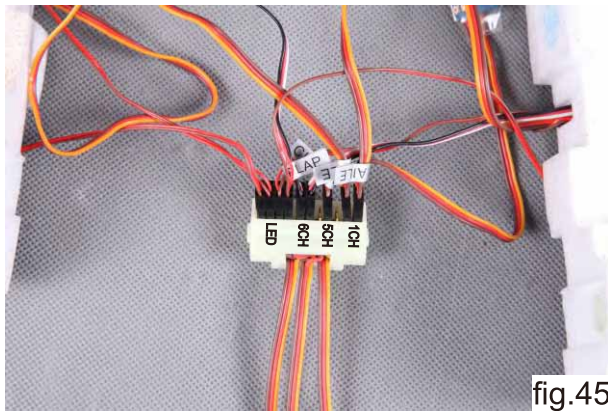

fig.45

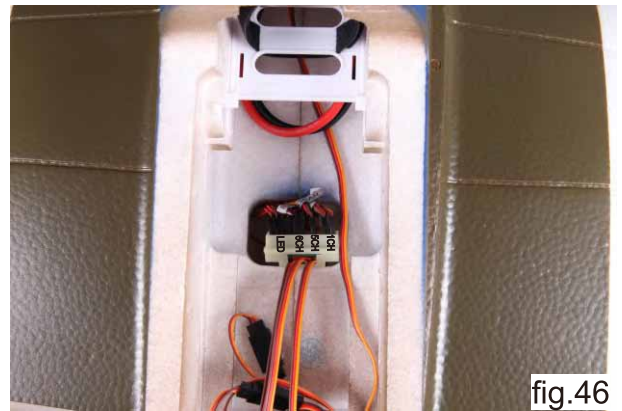

fig.46

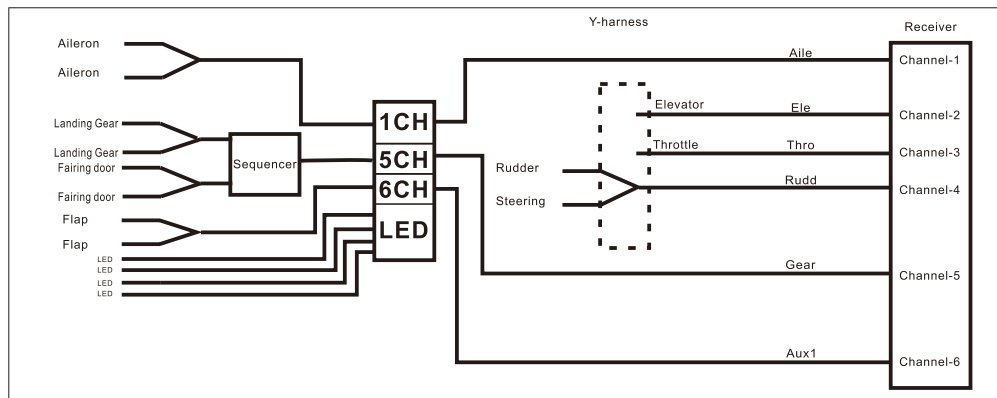

fig.47

Install the Battery

- 39) The battery hatch is located in front of the canopy bay. Slide the battery into the battery tray with the power cord facing toward the tail of the plane (fig. 48). Note: The battery tray is designed to slide out to make securing the battery with the velcro straps easier.



Generic Binding Instructions

Binding is the process of programming your receiver to respond to your specific transmitter. Always follow your radio equipment manufacturer's specific binding instructions. Below is a typical generic procedure for reference:

1. Power off the transmitter.
2. Set the throttle control on the transmitter to its lowest position (all other controls should be at their neutral position).
3. Install binding plug in receiver bind port.
4. Connect the battery to the ESC.
5. The receiver LED will flash rapidly.
6. Turn on the transmitter while holding the bind button or switch in the bind position.
7. When the receiver binds, the LED on the receiver will turn on and remain steady.
8. Remove the binding plug from the receiver.

Note: We recommend re-binding the radio after all the control throw settings are adjusted. This will keep the servos from moving full stroke while the transmitter and receiver connect.

ESC Information

Please refer to the separate ESC Manual for detailed information about your programmable ESC.

Motor Rotation

The motor and ESC comes pre-connected. The direction of motor rotation should be counterclockwise (fig. 52). If the motor is rotating in the wrong direction, simply reverse two of the three motor wires to change the direction of rotation.

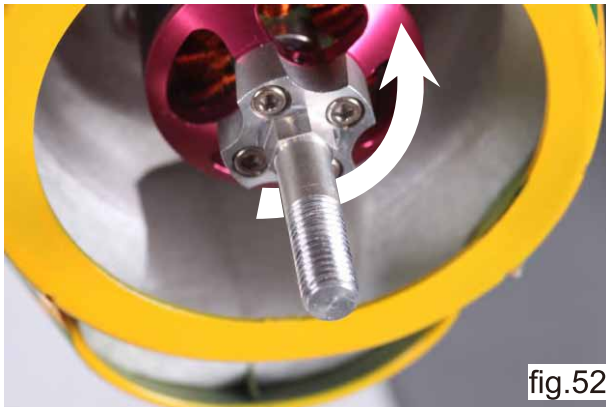

Control Surfaces

Center Adjustment (trim)

1. Follow all safety precautions as outlined in this manual and your transmitter manufacturer's manual, including setting the throttle to the off position.
2. Turn on the transmitter and plug in the ESC battery.
3. Center all the trim controls on the transmitter.
4. Look at all the control surfaces to determine which ones need adjustment.
5. Unplug the ESC battery and turn off the transmitter before attempting any adjustments.
6. Adjust clevises as necessary to center control surfaces to their neutral position.
7. Repeat steps 1 thru 4 to verify adjustments.
8. If more adjustment is required, repeat steps 5 and 6 until process is completed.

Please see the following for reference; flaps (fig. 53), ailerons (fig. 54), rudder (fig. 55), elevator (fig. 56), rear landing gear (fig. 57). Note: the rear landing gear neutral position is adjusted by loosening the screw on the control connector and moving the linkage rod. Tighten the screw when the adjustment is complete (fig. 58).

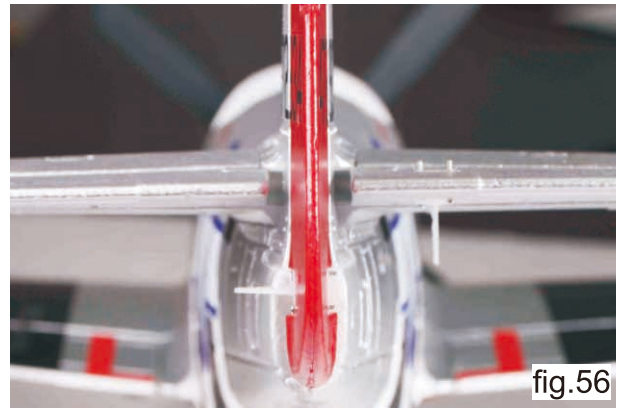
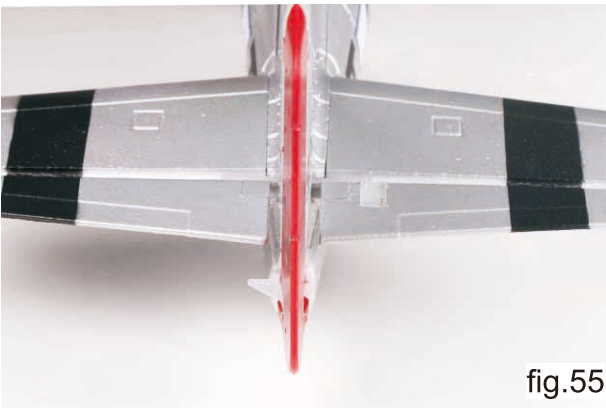
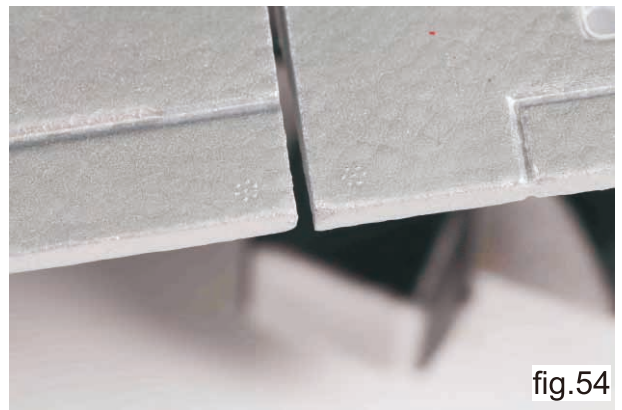

Direction Check

Turn on your transmitter and receiver. Viewing the model from the rear (fig. 59), move the controls on the transmitter per the instructions that follow and verify the control surfaces are responding in the appropriate direction. You may have to reverse the direction of one or more channels on your transmitter to correct any issues.

1. Move the left joystick to the right. The rudder should move to the right. Move the joystick to the left. The rudder should move to the left. Reverse channel on transmitter if necessary.
2. Move the right joystick down towards the bottom of the transmitter. The elevator should move up. Move the joystick towards the top of the transmitter. The elevator should move down.



fig.59

3. Move the right joystick to the right. The right aileron should go up. The left aileron should go down. Move the joystick to the left. The right aileron should go down. The left aileron should go up.

Travel Settings (throw)

Adjust the throw by moving the clevis position on the control surface horns. A commercially available gauge is helpful in this task though not required. If you have a single rate transmitter, adjust throws to low rate settings. If you have a dual rate transmitter, adjust the throws to achieve high rate settings.

Aileron Control Throw Setting (low rate)

17 mm up/down (fig. 60-62). Set other surfaces to their respective rates in the same manner.



fig.60



fig.61

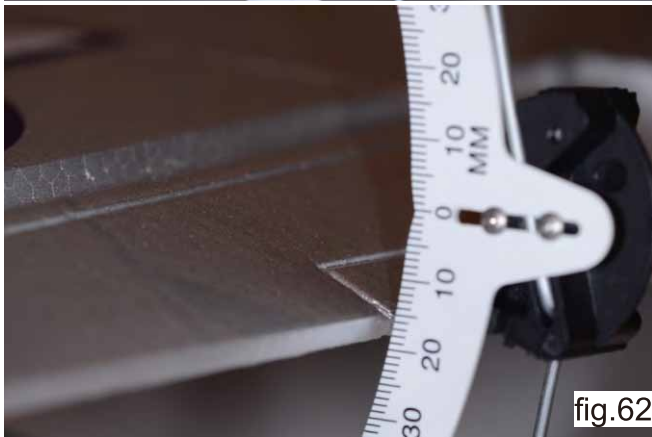

fig.62

Elevator Control Throw Setting (low rate)

24 mm up/down

Rudder Control Throw Setting (low rate)

21 mm left/right

Flaps Control Throw Setting (low rate)

22 mm mid down

45 mm full down

Note: Measure the throw (deflection) at the widest point (chord) of each control surface. For example, on the flaps, measure the throw on the fuselage side of the flap, not the aileron side. The deflection measurement will be largest on the fuselage (widest) side.

Dual Rates and Exponential Recommendations

On many transmitters, dual rates can be setup for aileron, elevator, and rudder channels. If your transmitter is capable, designate a switch on the transmitter to change between a low and high rate of servo travel for each channel. Low rates are for normal flying. High rates are for extreme aerobatics.

To use dual rates, the control surface throw settings should be set to equal the high rate settings. When the transmitter switch is in the high rate position, the control surface will travel 100%. When the transmitter switch is in the low rate position, the servo will travel less than 100% (a percentage that you determine) to make the control surface throw equal to the low rate deflection.

Aileron high rate 28mm up/down

Elevator high rate 40mm up/down

Rudder high rate 25mm left/right

Final Assembly, Detailing, and Propeller Set

- 1) With the landing gear in the lowered position, use a magnetic screwdriver to secure the leading edge side of the horizontal stabilizer with the provided (PA 2.6x20mm) screw (fig. 63-66).

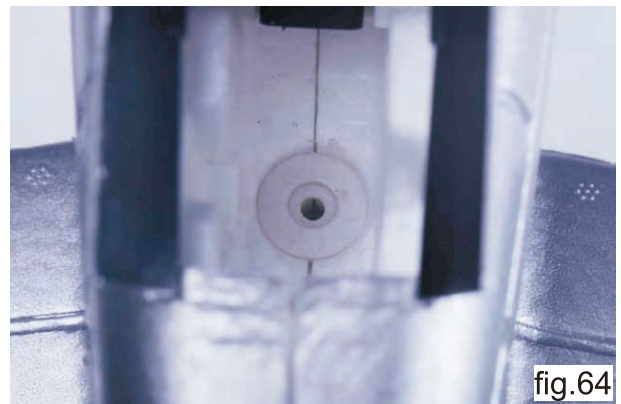

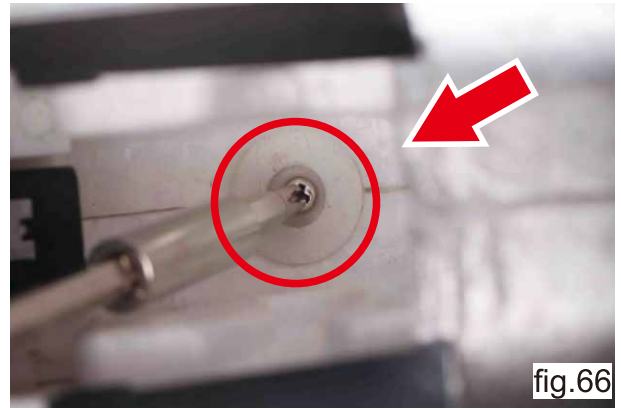
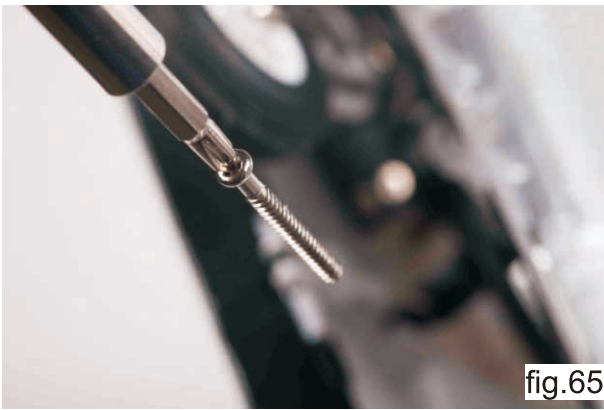

- 2) Apply glue evenly to the notch in both side of the fuselage where the exhaust stacks mount (fig. 67).
- 3) Insert the exhaust stacks “L” in the correct orientation (fig. 68).



- 4) Install the antenna “M” in its corresponding slot after using a toothpick to apply the glue in the slot (fig. 69).
- 5) Locate the machine gun sets “N” (fig. 70).

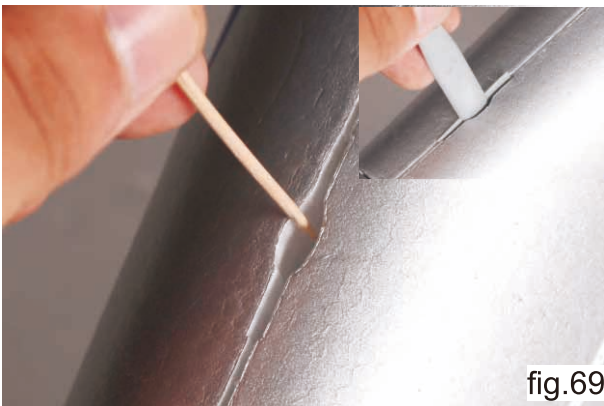

- 6) Test fit one of the gun sets on the leading edge of one side of the wing. If it is the correct gun set it will fit perfectly with the gun barrel facing straight forward. If it doesn't fit correctly, try the other gun set (fig. 71).
- 7) Once you have determined where each gun set fits, take each gun set back off and then glue it back in place (fig. 72).



fig.71



fig.72

- 8) Slide on the external fuel tanks "O". The two tanks are identical. You can mount either tank on either side (fig. 73 & 74).



fig.73



fig.74

- 9) Apply decals "P" (fig. 75) per the illustrated guide (fig. 76-77).

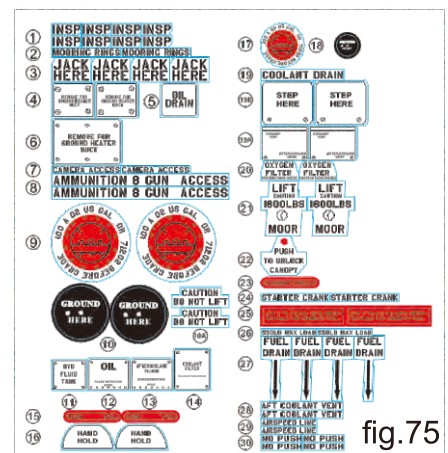

fig.75

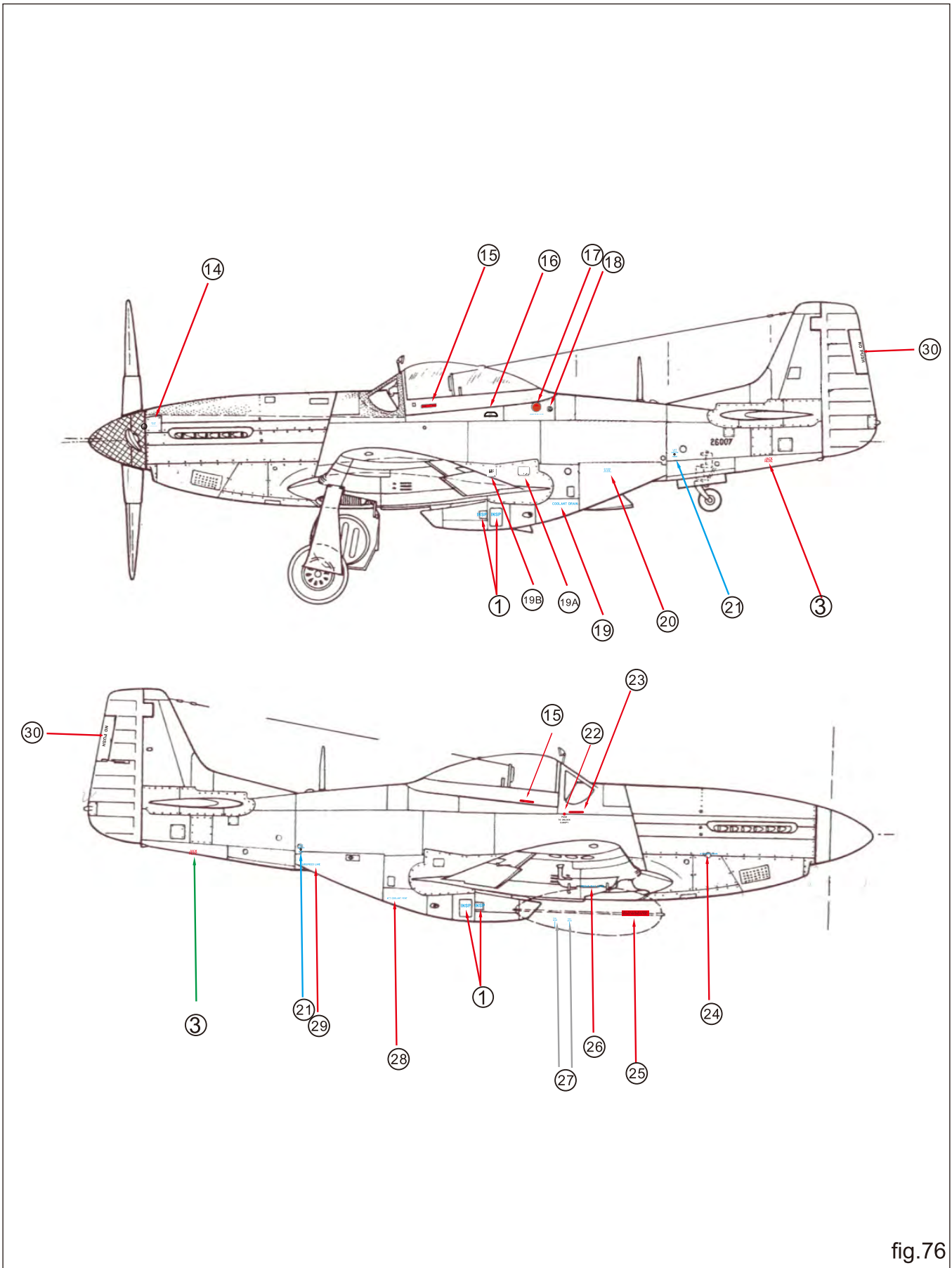

fig.76

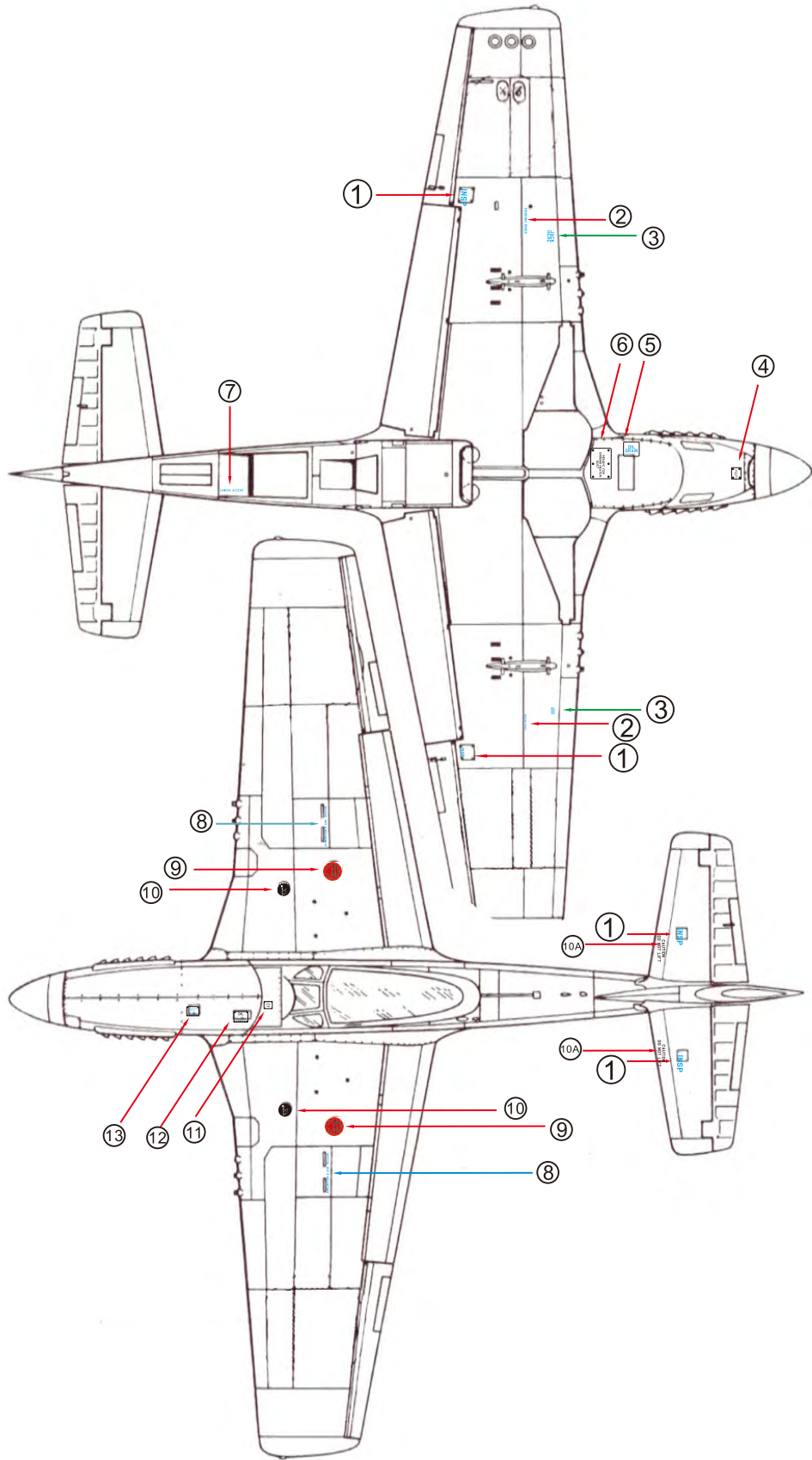

fig.77

Install the Propeller Assembly

- 10) Key the propeller assembly to the motor shaft by fitting the assembly over the hex nut on the shaft (fig. 78).
- 11) Install the washer on the motor shaft (fig. 79)



- 12) Secure the propeller assembly by tightening the nut with a screwdriver. (fig. 80).
- 13) Align the holes in the spinner with the dowels on the backplate that hold the screws (fig. 81)

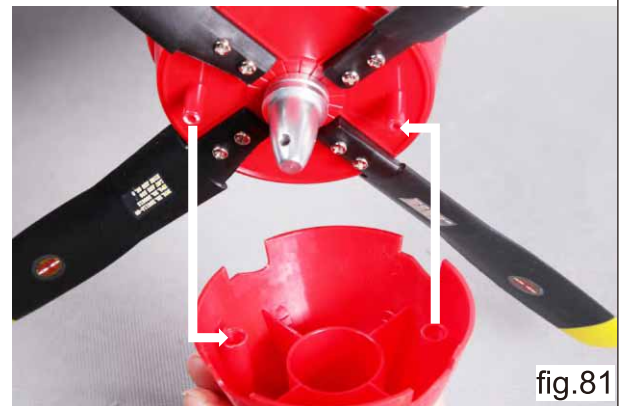

- 12) Install the spinner (fig. 82).
- 13) Secure the spinner using the two provided (PA 2.6x10mm) screws (fig. 83).



fig.82



fig.83

Center of Gravity

Before balancing your model, make sure the it is completely assembled, the battery is installed, and the retractable landing gear is in the lowered position. The recommended center of gravity (CG) for your model is 110mm from the wing's leading edge (measured at point of contact with fuselage). Lightly mark the ideal center of gravity position on the top surface of the wing on each side of the fuselage. Support the plane inverted at the marks made on the top of the wing with your fingers or a commercially available balancing stand. It should be level or just slightly nose down. Adjust the position of battery as necessary to achieve the proper balance.

Pre-flight Checklist

Prior to first flight:

1. Ensure your transmitter and ESC batteries are fully charged per manufacturer's instructions.
2. Ensure propeller is properly secured.
3. Ensure receiver and ESC battery are secure.
4. Check all control surface actuating hardware (linkages, screws, nuts, bolts, etc.)
5. Perform a range test on the radio equipment.
6. Check control surfaces for proper direction and throw.
7. Check center adjustment of each control surface.
8. With someone holding the aircraft, start the motor and make sure it runs smoothly. Ensure it will transition from off to high throttle and back to off.

Flight Safety

1. Do not fly in strong winds or bad weather.
2. Never fly in crowded areas near people, cars, buildings, power lines, airports, etc. The plane can travel at high speed so choose a wide open space and give yourself plenty of room to operate. Remember you are responsible for the safety of others.
3. Not recommended for children under 14 years of age. Children under 12 must have adult supervision.
4. Never use or leave the battery charger in a wet environment.
5. Keep the model away from heat which can easily destroy the foam structure of the plane, the electronics, or the battery.

6. Do not attempt to catch the model while flying.
7. Stay clear of the propeller at all times, even when it is not moving because the transmitter could easily be bumped and cause the propeller to move without warning.
8. Never leave the model unattended with a battery installed. Injury could be caused by children or unaware adults turning on the transmitter.
9. When preparing for flight, turn the transmitter on and ensure the throttle is off before connecting the battery.

Daily Flight Checks

Prior to first flight:

1. Check condition of major components. Ensure wing, tail, motor, and landing gear are secure.
2. Check condition of propeller.
3. Check all control surface actuating hardware (linkages, screws, nuts, bolts, etc.)
4. Check the voltage on the transmitter and ESC batteries.
5. Perform a range test on the radio equipment.
6. Check control surfaces for proper direction and throw.
7. Check center adjustment of each control surface.

Post flight:

1. Disconnect ESC battery
2. Turn off transmitter
3. Remove ESC battery from model.
4. Recharge ESC battery.
5. Store ESC battery away from model in fire proof container.
6. Repair or replace any damaged parts on the model airplane.

Maiden Flight Tips

If this is your first RC Model Airplane, you may want to seek the help of an experienced pilot to assist you on the first flight. You can usually find people that are happy to assist at a local RC Club. You can also inquire at your local hobby shop. Often hobby shop employees will know where to go locally for flight assistance.

Whether you are a new or experienced pilot, the maiden flight for any new RC model can often be challenging. Even if you have followed all the instructions exactly and adjusted all the control surfaces to their neutral positions, the model will likely need to be “trimmed out”. Once you have the plane in the air, immediately climb to a safe altitude. Many RC Pilots will tell you that a safe altitude is “three mistakes high”. Reduce throttle to half. Put the plane on a straight and level trajectory. While trimming, hold your transmitter up high near eye level; this will make it easier to see your plane and your trim settings at the same time. The goal of trimming the plane is to adjust it so it will maintain straight and level flight with no control inputs. For example, if the plane climbs, add down elevator trim. If it dives, add up trim. You may also need to adjust rudder trim (and aileron trim if applicable). Make as many passes as necessary, putting the plane on a straight and level trajectory and making required trim corrections until the plane flies straight and level.

Monitor and limit your flight time using a timer (in your transmitter if available, or a wrist watch). To avoid a dead-stick landing on your first flight, conservatively set the timer to four minutes. When you hear the alarm, land your plane as soon as possible.

Routine Maintenance

Store Li-Po batteries at room temperature in a dry environment in a fire proof container. Periodically check the cell voltage. Do not let the voltage drop below the manufacturer's recommended minimum storage voltage (typically around 3.3V per cell).

Repairs to foam should be made with foam safe adhesives such as hot glue, foam safe CA, and 5 min epoxy.

Troubleshooting Guide

Troubleshooting Guide		
Problem	Possible Causes	Solution
Receiver will not bind to transmitter	Transmitter is too close to the receiver Transmitter or receiver is too close to a large metal object ESC battery or Transmitter battery is not charged Bind plug installed incorrectly in receiver	Move transmitter a few feet away from receiver and then unplug and reconnect the ESC battery Move transmitter a few feet away from receiver and then unplug and reconnect the ESC battery Charge ESC battery or Transmitter battery Follow manufacturer's instructions for binding and re-bind receiver
Control Surface(s) will not move	Transmitter/receiver not bound correctly Incorrect model selected on transmitter Loose connection Control linkage, clevis, horn not connected, binding or damaged Servo damaged ESC battery or Transmitter battery is not charged	Re-bind receiver to transmitter per manufacturer's instructions Select correct model on transmitter Check battery, ESC, and receiver connections Check all control linkage connections Replace servo Recharge/replace batteries
Control Directions reversed	Transmitter servo direction settings are reversed	Perform Control Surfaces Direction Test and reverse transmitter settings as necessary
Model responds to all controls except throttle	Throttle channel is reversed Throttle is not at idle or trim is too high on transmitter	Reverse throttle channel setting on transmitter Move throttle stick and trim to lowest setting
Motor pulses then loses power	Low ESC battery charge or damaged battery Battery "C" rating too small	Re-charge/replace ESC battery Use proper battery
Excessive noise or vibration at high throttle	Damaged propeller or motor Propeller is not balanced	Replace damaged part Replace defective propeller
Model underpowered or has a reduced flight time	Propeller installed backwards Propeller rotation direction incorrect ESC battery charge is too low or battery damaged	Install propeller with numbers facing towards you Perform Control Surfaces Direction Test and reverse transmitter settings as necessary Recharge/replace battery
Model will not climb	Elevator trim not adjusted correctly	Adjust elevator trim
Model keeps turning in same direction	Rudder trim not adjusted correctly Aileron trim not adjusted correctly	Adjust rudder trim Adjust aileron trim
Model is difficult to control	Wing or tail damaged Center of Gravity incorrect Inadequate or excessive control throw settings	Repair/replace as necessary Check center of gravity and correct as necessary. Make sure battery is secure (not moving in flight) Verify control throws are at recommended settings

Customer Support and Spare Parts Contact Information

FMS Team Product Support

3/F, Building B, 3rd Industry Zone, Matigang, Dalingshan Town,
Dongguan City, P.R.C.

Phone: 0086-769-86976655

Email: info@fmsmodel.com

Spare Parts List

Replacement parts for the FMS P-51D Mustang are available using the order numbers in the spare parts list that follows. The fastest, most economical service can be provided by your hobby dealer or mail-order company.

Spare parts list

Item# Description

SU-101	Fuselage
SU-102	Main wing (A pair of wing with the gear base installed)
SU-103	Vertical stabilizer
SU-104	Horizontal stabilizer
SU-105	Cockpit (Foam cockpit hatch)
SU-106	Canopy (Plastic canopy)
SU-107	Windshield
SU-108	Oil tank (A pair of identical oil tank)
SU-109	Rear landing gear hatch fairing door(Two pieces)
SU-110	Machine gun set (Starboard and port side machine gun)
SU-111	Air cooling intake
SU-112	Wing bolt plate (Two pieces: Front and the rear plate)
SU-113	Motor board
SU-114	Cowl
SU-115	Propeller (Four pieces blade)
SU-116	Spinner
SU-118	Main landing gear strut (A pair of main landing gear struts with the wheels installed)
SU-120	Rear landing gear system
SU-127	Aluminum motor base (With four pieces sink head screw)
SU-128	Motor shaft
SU-129	Linkage rod (All of the control surface linkage rod with clevis installed)
SU-130	Screw set
SU-131	Decal sheet
SU-132	Detailed decal sheet
SU-133	Tire set (A pair of main strut tires and a rear landing gear tire)
SU-134	The inner fairing door
SU-135	The outer fairing door
SU-136	Pipe
SU-137	Battery Tray
SU-138	Multiple Connector Part 1 (For the wing panels)
SU-139	Multiple Connector Part 2 (For plug to receiver)
SU-140	exhaust pipe
SU-141	Main landing gear system
SU-142	LED
SU-143	Lamp Cover
SU-144	Multiple Connector (new)
FMS-Motor	(4250-KV540)
FMS-ESC-70A	with 5A SBEC
FMS-9g	Positive slow servo flaps
FMS-9g	Digital metal gear servo positive
FMS-9g	Digital metal gear servo reverse
FMS-9g	Digital metal gear servo 54 DEGREE
FMS-17g	metal gear servo
FMS-Sequencer-6	sec P51
FMS-Retract	003

Note: 1. All spare parts without decals.

2. The Item# without color marking could be applied universally for all **FMS** color schemes.

Spare Parts List



SU-101



SU-102



SU-103



SU-104



SU-105



SU-106



SU-107



SU-108



SU-109

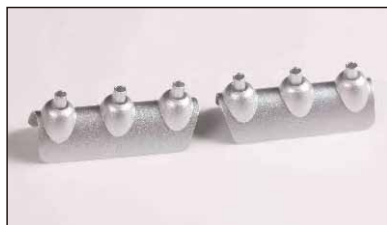

SU-110



SU-111



SU-112



SU-113



SU-114



SU-115



SU-116



SU-118



SU-120

Spare Parts List



SU-127



SU-128



SU-133



SU-134

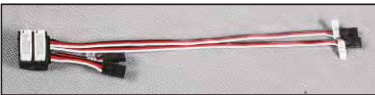

SU-139



SU-140



FMS-Motor (4250-KV540)



FMS-9g Digital metal gear servo positive



FMS-17g metal gear servo



SU-129



SU-130



SU-135



SU-136



SU-141



SU-142



FMS-ESC-70A 5A SBEC (200mm length cable)



FMS-9g Digital metal gear servo reverse

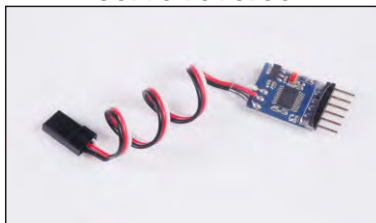

FMS-Sequencer-6 sec P51



SU-131

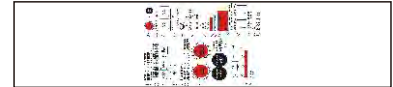

SU-132



SU-137

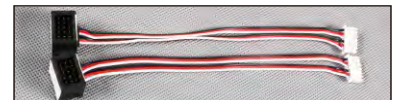

SU-138

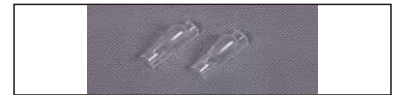

SU-143



SU-144



FMS-9g Positive slow servo flaps



FMS-9g Digital metal gear servo 54 DEGREE



FMS-Retract 003

AMA

If you are not already a member of the AMA, please join, The AMA is the governing body of model aviation and membership provided liability insurance coverage, protects modelers' rights and interests and is required to fly at most R/C sites.

Academy of Model Aeronautics

5151 East Memorial Drive

Muncie, IN 47302-9252

Ph.(800)435-9262

Fax(765)741-0057

Or via the Internet at: <http://www.modelaircraft.org>



Academy of Model Aeronautics National Model Aircraft Safety Code Effective January 1, 2011

A. GENERAL: A model aircraft is a non-human-carrying aircraft capable of sustained flight in the atmosphere. It may not exceed limitations of this code and is intended exclusively for sport, recreation and/or competition.

All model flights must be conducted in accordance with this safety code and any additional rules specific to the flying site.

1. Model aircraft will not be flown:
 - (a) In a careless or reckless manner.
 - (b) At a location where model aircraft activities are prohibited.
2. Model aircraft pilots will:
 - (a) Yield the right of way to all man carrying aircraft.
 - (b) See and avoid all aircraft and a spotter must be used when appropriate.
(AMA Document #540-D-See and Avoid Guidance.)
 - (c) Not fly higher than approximately 400 feet above ground level within three (3) miles of an airport, without notifying the airport operator.
 - (d) Not interfere with operations and traffic patterns at any airport, heliport or seaplane base except where there is a mixed use agreement.
 - (e) Ensure the aircraft is identified with the name and address or AMA number of the owner on the inside or affixed to the outside of the model aircraft.
(This does not apply to model aircraft flown indoors).
 - (f) Not operate aircraft with metal-blade propellers or with gaseous boosts except for helicopters operated under the provisions of AMA Document #555.
 - (g) Not operate model aircraft while under the influence of alcohol or while using any drug which could adversely affect the pilot's ability to safely control the model.
 - (h) Not operate model aircraft carrying pyrotechnic devices which explode or burn, or any device which propels a projectile or drops any object that creates a hazard to persons or property.

Exceptions:

- ◆ Free Flight fuses or devices that burn producing smoke and are securely attached to the model aircraft during flight.
 - ◆ Officially designated AMA Air Show Teams (AST) are authorized to use devices and practices as defined within the Team AMA Program Document (AMA Document #718).
3. Model aircraft will not be flown in AMA sanctioned events, air shows or model demonstrations unless:
 - (a) The aircraft, control system and pilot skills have successfully demonstrated all maneuvers intended or anticipated prior to the specific event.
 - (b) An inexperienced pilot is assisted by an experienced pilot.
 4. When and where required by rule, helmets must be properly worn and fastened. They must be OSHA, DOT, ANSI, SNELL or NOCSAE approved or comply with comparable standards.

B. RADIO CONTROL (RC)

1. All pilots shall avoid flying directly over unprotected people, vessels, vehicles or structures and shall avoid endangerment of life and property of others.
2. A successful radio equipment ground-range check in accordance with manufacturer's recommendations will be completed before the first flight of a new or repaired model aircraft.
3. RC model aircraft must use the radio-control frequencies currently allowed by the Federal Communications Commission (FCC). Only individuals properly licensed by the FCC are authorized to operate equipment on Amateur Band frequencies.
4. RC model aircraft will not operate within three (3) miles of any pre-existing flying site without a frequency-management agreement (AMA Documents #922-Testing for RF Interference; #923- Frequency Management Agreement)
5. With the exception of events flown under official AMA Competition Regulations, excluding takeoff and landing, no powered model may be flown outdoors closer than 25 feet to any individual, except for the pilot and the pilot's helper(s) located at the flight line.
6. Under no circumstances may a pilot or other person touch a model aircraft in flight while it is still under power, except to divert it from striking an individual. This does not apply to model aircraft flown indoors.
7. RC night flying requires a lighting system providing the pilot with a clear view of the model's attitude and orientation at all times.
8. The pilot of a RC model aircraft shall:
 - (a) Maintain control during the entire flight, maintaining visual contact without enhancement other than by corrective lenses prescribed for the pilot.
 - (b) Fly using the assistance of a camera or First-Person View (FPV) only in accordance with the procedures outlined in AMA Document #550.

C. FREE FLIGHT

1. Must be at least 100 feet downwind of spectators and automobile parking when the model aircraft is launched.
2. Launch area must be clear of all individuals except mechanics, officials, and other fliers.
3. An effective device will be used to extinguish any fuse on the model aircraft after the fuse has completed its function.