

# TRX4

## Body Assembly

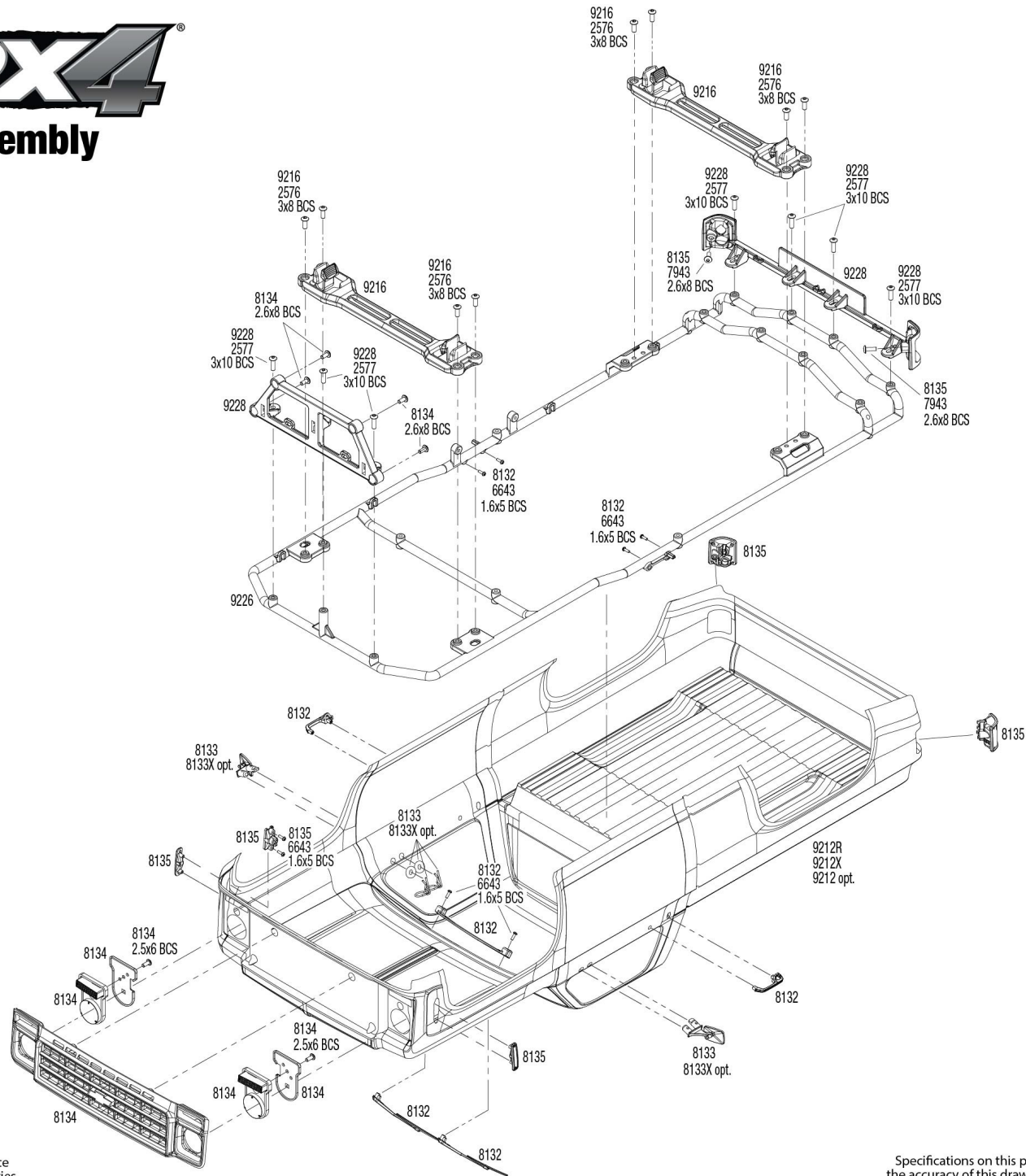

Completed Assembly  
(view from bottom)

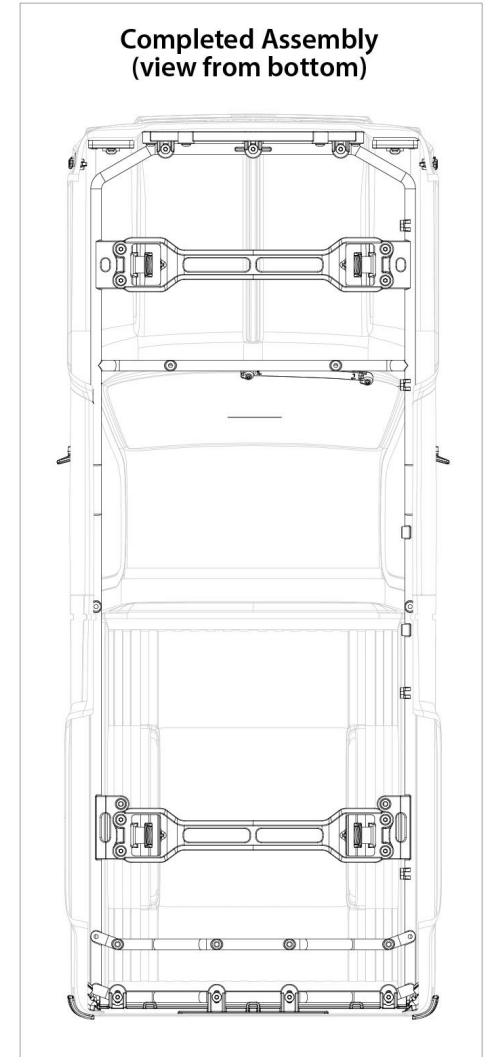

See Parts List for a complete listing of optional accessories.

REV 240327-R06  
Specifications on this page are subject to change without notice. Every attempt has been made to ensure the accuracy of this drawing; however, Traxxas cannot be held responsible for typographical or other errors.





# TRX4<sup>®</sup>

## Front Assembly

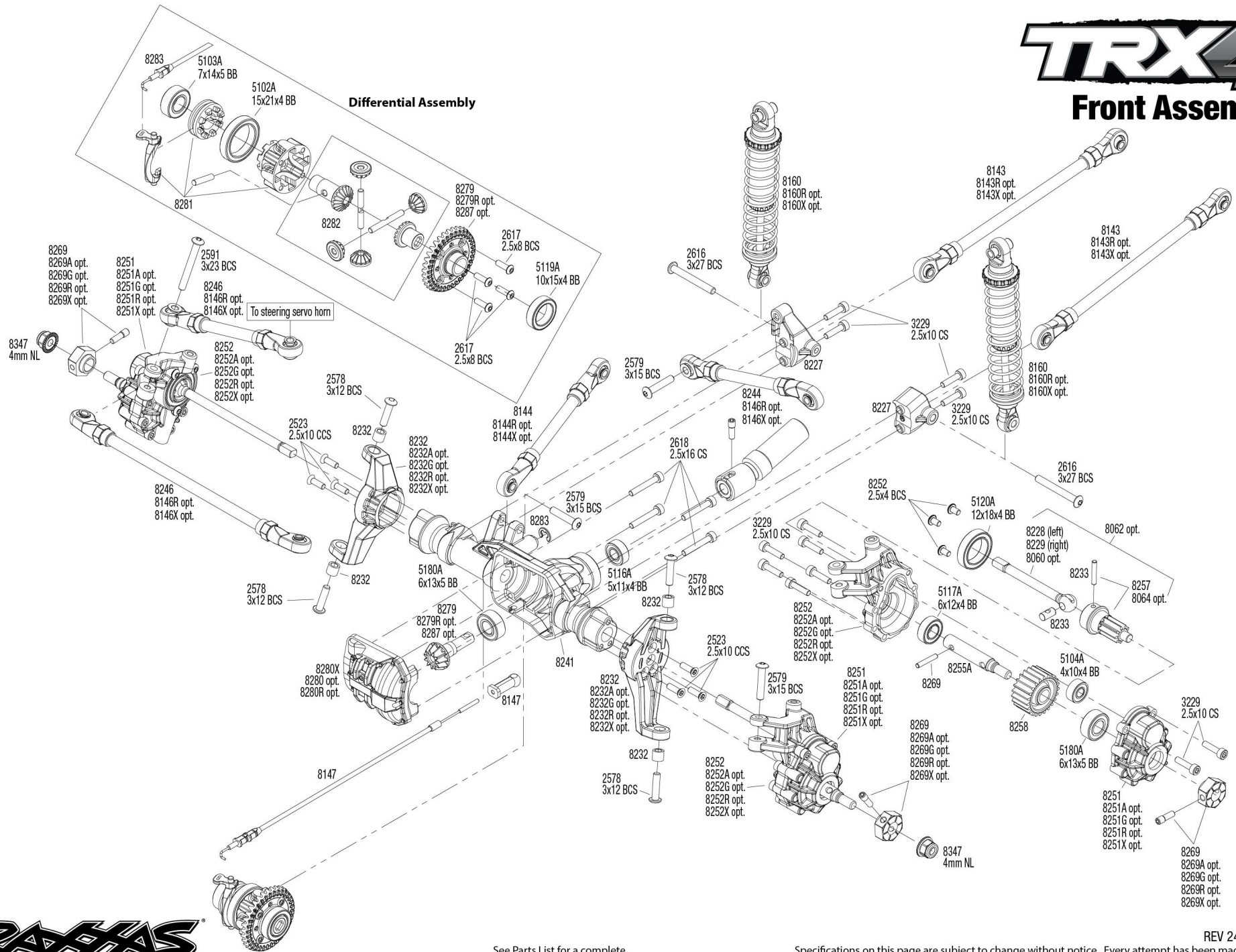

See Parts List for a complete listing of optional accessories.

Specifications on this page are subject to change without notice. Every attempt has been made to ensure the accuracy of this drawing; however, Traxxas cannot be held responsible for typographical or other errors.

REV 240327-R06

# TRX4<sup>®</sup>

## Front Assembly

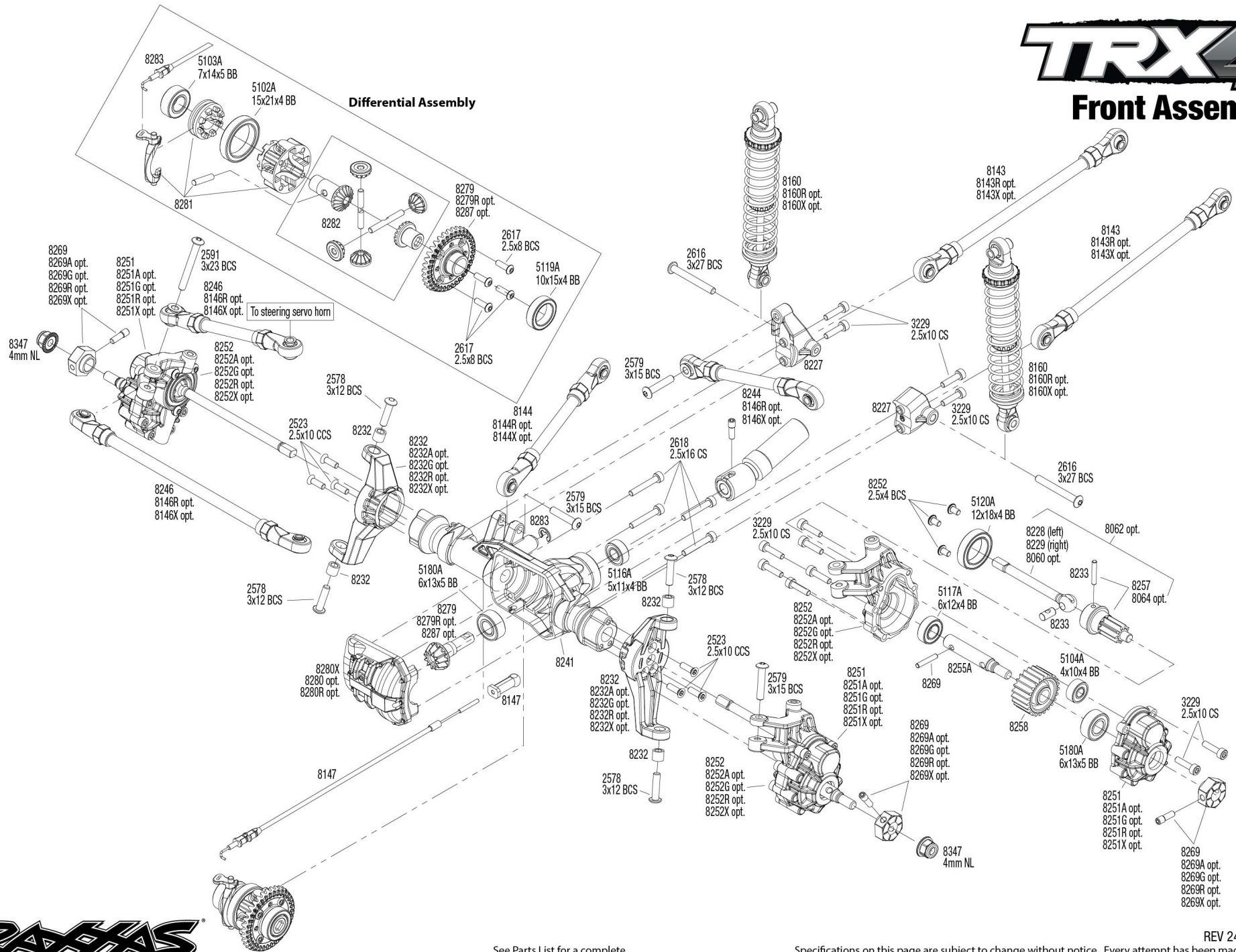

See Parts List for a complete listing of optional accessories.

Specifications on this page are subject to change without notice. Every attempt has been made to ensure the accuracy of this drawing; however, Traxxas cannot be held responsible for typographical or other errors.

REV 240327-R06





# Link Dimensions

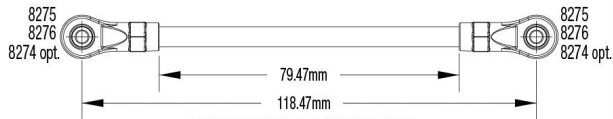

**FRONT LOWER LINK (QTY. 2)**

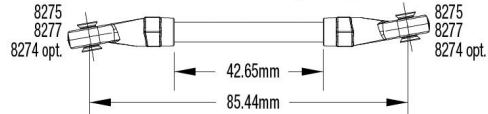

**FRONT UPPER LINK (QTY. 1)**

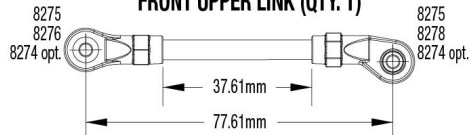

**PANHARD BAR (QTY. 1)**

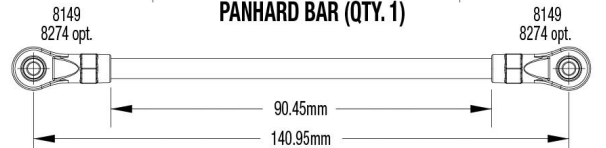

**REAR LOWER LINK (QTY. 2)**

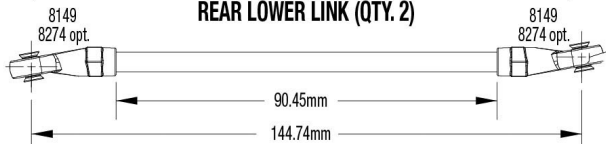

**REAR UPPER LINK (QTY. 2)**

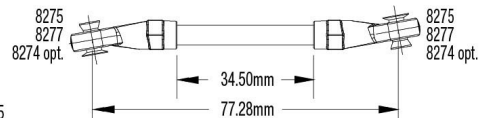

**STEERING LINK (QTY. 1)**

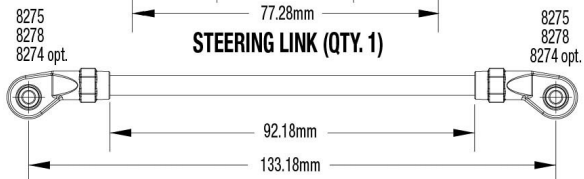

**DRAG LINK (QTY. 1)**

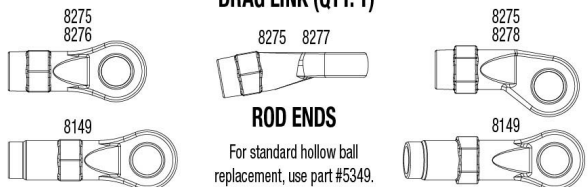

# Modular Assembly

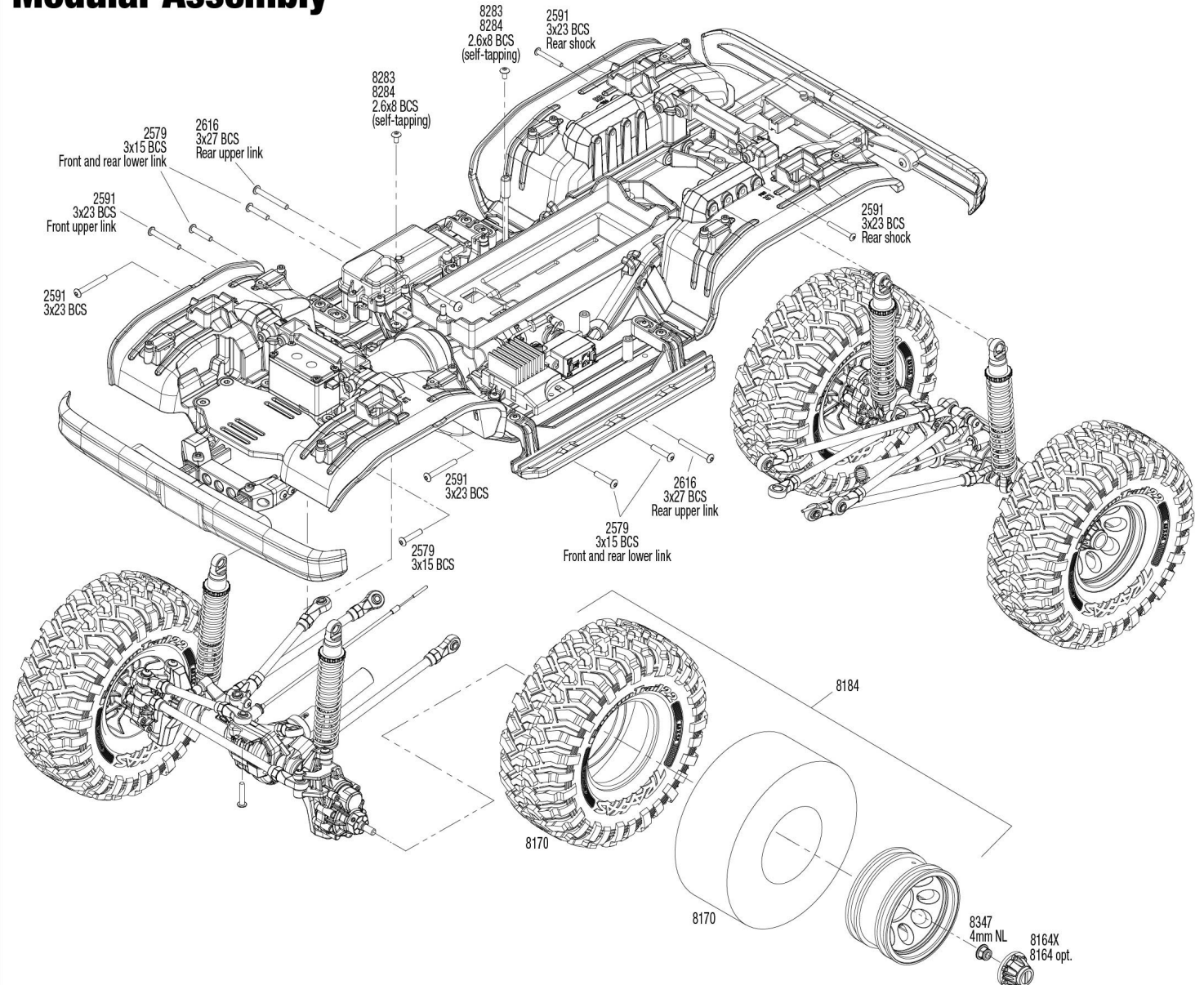

See Parts List for a complete listing of optional accessories.

Specifications on this page are subject to change without notice. Every attempt has been made to ensure the accuracy of this drawing; however, Traxxas cannot be held responsible for typographical or other errors.

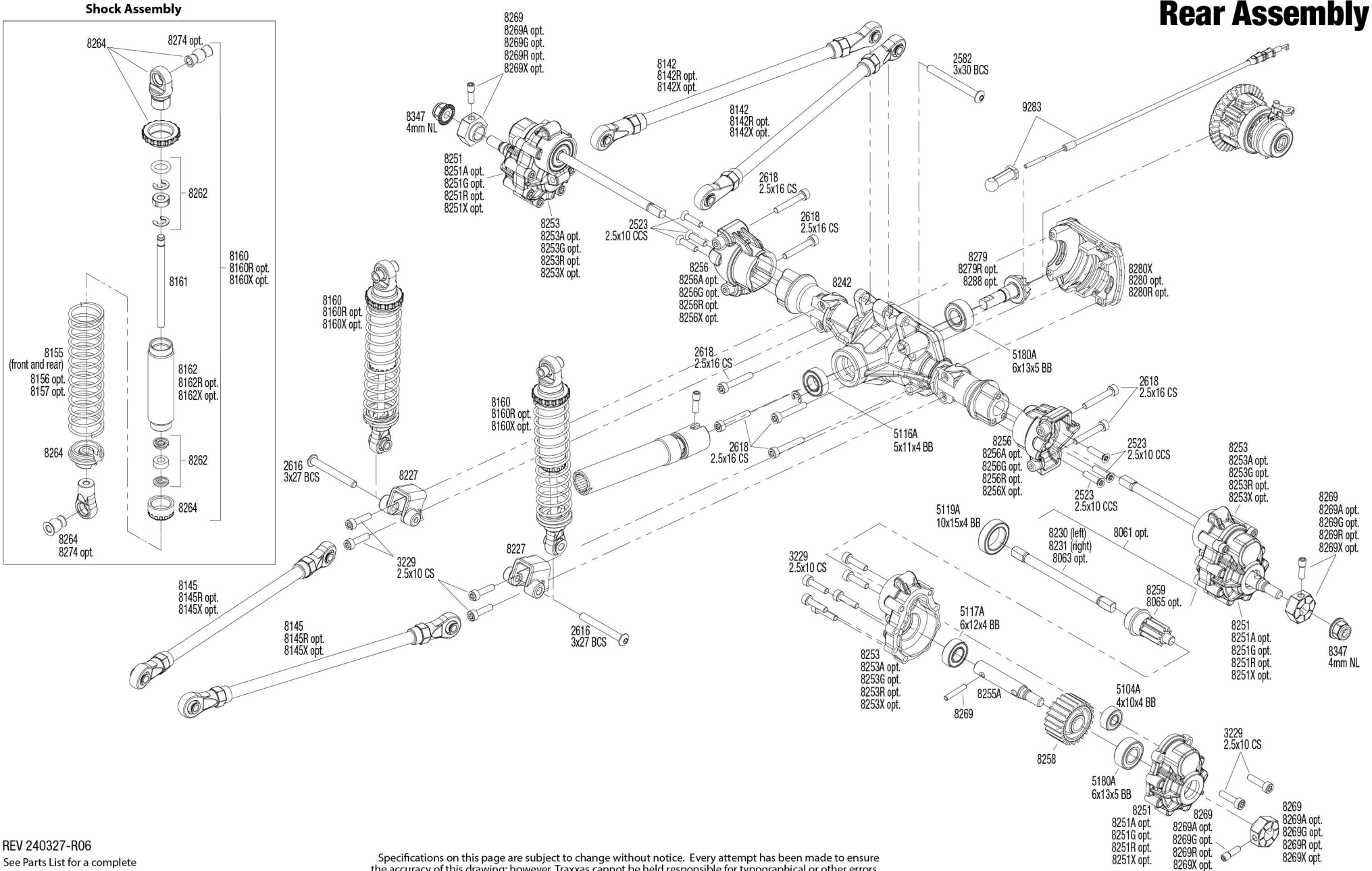





### Driveshaft Length Indicators

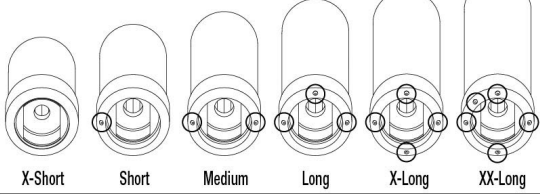

# Transmission Assembly

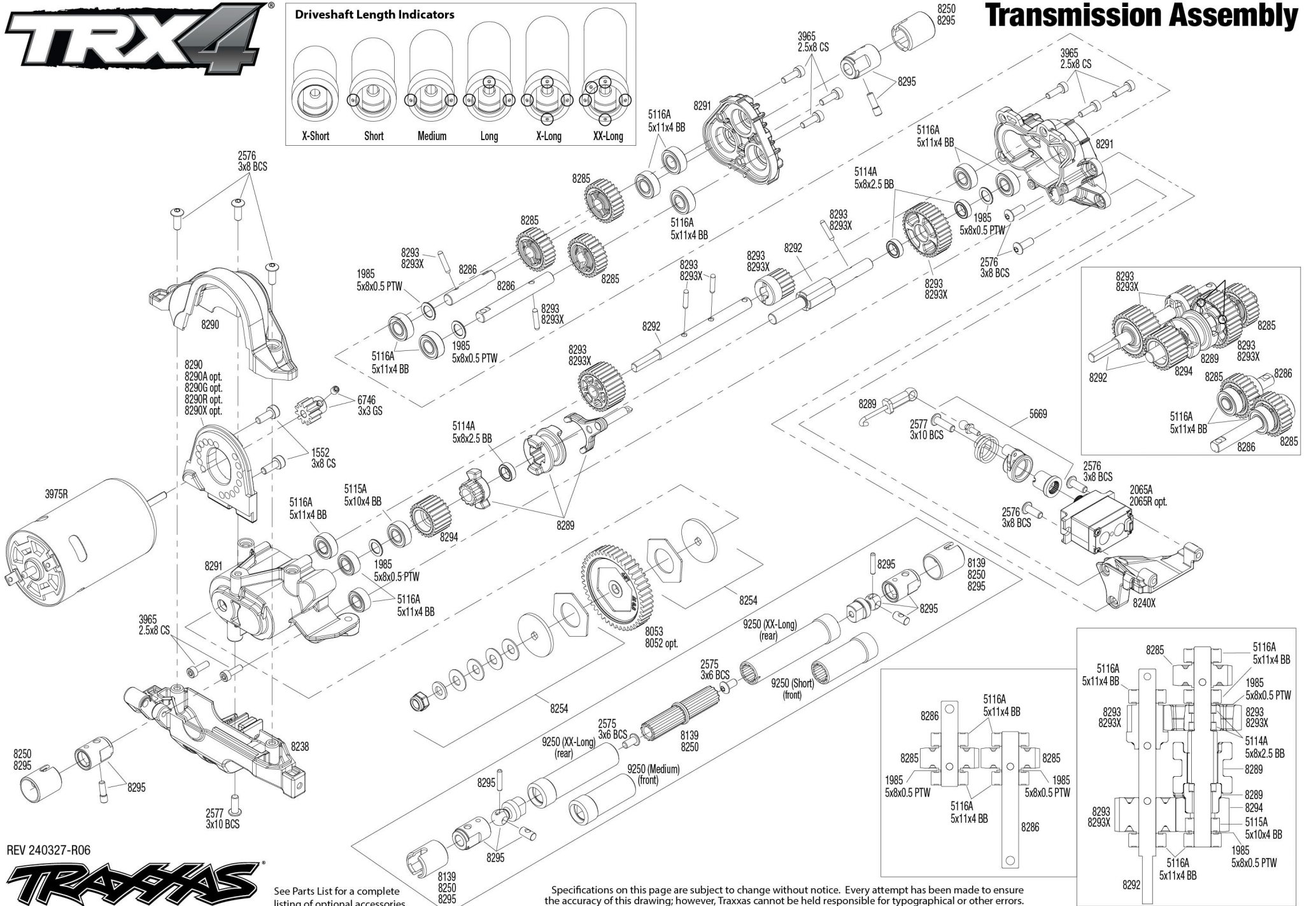

REV 240327-R06



See Parts List for a complete listing of optional accessories.

Specifications on this page are subject to change without notice. Every attempt has been made to ensure the accuracy of this drawing; however, Traxxas cannot be held responsible for typographical or other errors.