



# RASCAL R/C

*... Classic Hang Time*



## INSTRUCTION BOOK

**Sig Mfg. Co., Inc....401-7 South Front Street...Montezuma, Iowa 50171**

### Introduction

The original Rascal design dates back to the early fifties. The Rascal was introduced by Top Flite Models, Inc., as the flagship for their highly successful Jig-Time series of all-sheet balsa, rubber powered models. Many modelers who are now of an age, may recall the Rascal as a very nice looking and equally nice flying airplane. All of these attributes were delivered to the modeler for the price of \$.69, with a Guaranteed To Fly certificate! This was a price that any self-respecting kid with a paper route could afford.

We fondly recall many afternoons building these models with other aviation-minded friends, all of us wiping the excess "Ambroid" glue on our blue jeans, to the chagrin of our moms. Those afternoon building sessions were soon followed by flying these great little airplanes under the streetlights in the early evening. Wonderful memories of a simpler time! We never forgot the fun we had with these models and the wonderful lines of the original Rascal design. Even though the little Rascal is long gone, SIG is pleased to offer you a new R/C version of this attractive design. Like the original, the SIG R/C Rascal retains the classic lines of early postwar private airplanes and has the great flying characteristics of a true thoroughbred design.



SIG's R/C Rascal has been designed to be powered by either geared Speed 400 electric motors or .049 -.07 glow engines. Either power source provides you with a great flying model that can be flown almost anywhere. The design is small enough to be flown in fairly confined areas such as a park, and large enough to turn in good thermaling capabilities. During the development and testing of the design, we routinely got flight times of 15 to 25 minutes, picking up a little thermal lift during the flights. Electric versions of the R/C Rascal can typically weigh about 23 ounces, depending upon the radio system and batteries used! This lightweight gives the model a light wing loading, allowing it to remain flying longer. Glow engine powered versions of the Rascal can be even lighter, also performing beautifully. The airfoil used on this design is a fairly conservative flat-bottom type with a slight amount of Phillips entry at the leading edge. This allows the Rascal to handle a reasonable amount of wind for its size.

The SIG R/C Rascal kit is virtually 100% laser-cut, providing you with very accurate parts fit. The wing is especially interesting and unique. Taking advantage of laser technology, we have been able to pre-cut the top and bottom wing skins for you. Using the instruction methods provided in this manual, you'll be able to easily create the great looking elliptical wing and tip shapes, typical of the original airplane. The egg-crate spar system is simple, strong and lightweight, allowing you to build the wing panels very quickly. The fuselage is equally light in weight but still very strong. It has a nice looking open area behind the wings that lends itself to transparent coverings, if you wish. Even though the original Rascal didn't have wheel pants, we couldn't resist adding them to this design for a more rakish look. Heck, we even made sure the tailwheel/tailskid has a matching wheel pant!



Finally, your R/C Rascal is loaded with the best hardware and most innovative parts available, giving you a truly lightweight airplane that will give you many, many enjoyable flights.

**It is important that you make your power decisions before you begin construction. We have included two plywood firewalls, one for electric power and one for use with glow engines. Be sure to choose the one you need for your R/C Rascal.**

### COMPLETE KIT PARTS LIST

COMPLETE KIT PARTS LIST			
<b>Laser Cut Balsa</b>			
1 SH#1; 1/16"x3"x18" W-4, W-5, W-6, W-7, W-8 Wing RibS	1 SH#2; 3/32"x3"x18" Formers F-1, F-3, F-5, F-6, F-7, Nose Bottom Doubler, Servo Tray, & Tail Skid Pants	1 SH#3; 1/16"x4"x24" Stabilizer & Fin Frame	2 SH#4; 1/16"x6"x36" Fuselage Side & Nose Doublers
2 SH#5; 1/16"x3"x24" Wing Top Leading Edge	4 SH#6; 1/16"x4"x30" Wing Trailing Edge	1 SH#7; 3/16"x3"x18" Elevator(2), VF-3, & Rudder	1 SH#10; 3/32"x3"x12" W-1, W-2, W-3, W2-A Wing Ribs
1 SH#12; 3/32"x3"x24" Spar Webs	2 SH#13; 1/16"x4"x24" Stabilizer Frame & Tip, Fin Frame & Top	2 SH#14; 1/16"x3"x24" Wing Bottom Leading Edge	1 SH#15; 1/16"x4"x18" Wing Panels - Top, Bottom, Rear & Center
1 SH#16; 1/16"x4"x12" Wing Center - Top, Bottom, Rear & W-9			
<b>Laser Cut Lite-Ply Plywood</b>			
1 SH#8; 1/8"x4"x6" Firewalls, WP Mounts, LG. Supports, Hatch Mount & Wing Mount Plate			
<b>Laser Cut Birch Plywood</b>			
1 SH#9; 1/16"x4"x12" Dihedral Brace, Hatch, LG. Brace, W-8, F-4, Wing Sanding Jig	1 SH#11; 1/64"x6"x16" Fuselage Doublers, Control Horns & Servo Tray Doubler		
<b>Laser Cut Russian Plywood</b>			
1 SH#17; 1/8"x2-1/2"x2-1/2" Electric Motor Mount			
<b>Balsa Sticks</b>			
2 1/16"x1/4"x36" Wing Cap Strips	3 1/16"x1/8"x36" Stabilizer Cap Strips & Fuselage Brace	4 1/8"x1/8"x36" Fuselage Longerons	3 1/16"x1/16"x36" Fuselage Stringers
1 1/16"x1/2"x6" Fin Leading Edge	1 1/4" Tri. x24" Fin/Fuse Fillets	1 3/16" Sq. x6" Tank Support	

<b>Sheet Balsa</b>							
2	1/16"x3"x36" Balsa Sheet (Fuselage)						
<b>Hardwood</b>							
1	3/16"x3/16"x3" Elevator Joiner (Spruce)	2	5/32" Dia. x1-1/4" Wing Dowels				
<b>Shaped Balsa</b>							
2	24" Long Shaped Leading Edge	1	2" Long Shaped Wing Center Section Block	7	1/16"x1/4"x1" Tapered T.E. Stock (Shims)		
<b>Hardware</b>							
8	2-56x3/8" Slotted Bolts (Wheel Pant Mounts & Motor Mount)	8	2-56 Blind Nuts (Wheel Pants & Motor Mount)	1	8-32x1" Nylon Wing Bolt	4	1/16" Dia. x1/4" Brass Tube (Pushrods)
2	3/32" Dia. x3" Aluminum Tube (Fuselage Cabin Braces)	1	1/16" Dia. x1/2" Aluminum Tube (Tail Skid Brace)	1	5/16" Dia. x1/4" Drilled Wing Dowel	2	3/32" Landing Gear Clips
2	#2x3/8" Sheet Metal Screws (Hatch Mount)	2	Gem #1 Paper Clips (P/R Connectors)				
<b>Pre-Bent Music Wire</b>							
1	3/32" Dia. Pre-Bent Main Gear Wire	1	1/32" Dia. Pre-Bent Tail Skid				
<b>Plastic Parts</b>							
1	Set of .030 Molded Wheel Pants	1	.008x3"x17" Clear Plastic For Windshield & Side Windows				
<b>Miscellaneous</b>							
3	.031x18" Steel Cable (Throttle, Rudder & Elevator)	3	.073 O.D.x18" Nylon Tube (Throttle, Rudder & Elevator)	1	2-1/2"x4-1/4" Card Stock (Main Gear Fairings)	1	1"x4-1/4" Velcro (Battery Hold Down)
1	19"x25" Full Size Plan Sheet 1	1	19"x25" Full Size Plan Sheet 2	1	19"x25" Full Size Plan Sheet 3	1	9-1/2"x25" Full Size Plan Sheet 4
1	5"x13-1/2" Decal Sheet	1	Printed Instrument Panel	1	Photo-Illustrated Instruction Book		

## Items Needed To Complete Kit

### Electric Version

- Speed 400 Motor and Gearbox - Maxx #ACC347
- 7 or 8-cell 600 AE Battery Pack with Connectors
- Speed Controller for 7-8 Cells
- Battery Pack Charger - A/C-D/C Type
- Battery Connectors, such as Sermos
- 16 gauge red & white hook-up wire
- Electric Motor Mount - Maxx #ACC314

### Glow Engine Version

- .049 - .07 R/C Engine
- Sullivan 2 ounce Slant Fuel Tank, #SS-2 436
- Third Servo for Throttle Control
- 250 - 350 maH Airborne Battery Pack
- Dave Brown #0506 Motor Mount
- Small Diameter Fuel Tubing

### Common To Both Versions

- Radio System with small micro or mini servos and a small receiver
- Covering Material - Two 6 rolls typical for multi-color scheme
- Williams Bros. 1-7/8 diameter wheels - #150
- Typical Hobby Tools: Hobby knife with sharp blades, Dremel Tool and bits, selection of drill bits, razor blades, sandpaper, and sanding blocks of various sizes, pliers, good soldering iron and solder, etc.

# KEY TO LASER-CUT PARTS

**Sheet 12**  
3/32 Balsa

**Sheet 2**  
3/32 Balsa

F-1

F-7

F-3

Nose BT. Doubler

Servo Tray

F-5

Tail Skid Part

F-6

**Sheet 4** 1/16 Balsa

Fuselage

Nose

Doublers

Glow

Electric

Fuselage Side

**Sheet 7** 3/32 Balsa

Rudder

VF-3

Elevator

Elevator

**Sheet 17**  
1/8 Russian Plywood

Electric Motor Mount

**Sheet 6**  
1/16 Balsa

Wing Panel Trailing Edge

**Sheet 5**  
1/16 Balsa

Wing Panel Top Leading Edge

## KEY TO LASER-CUT PARTS

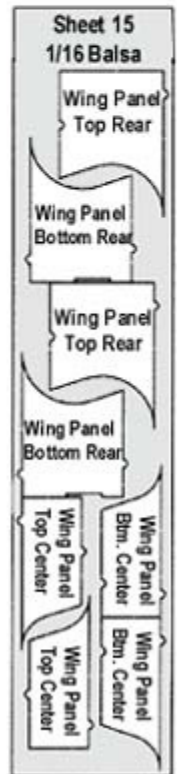
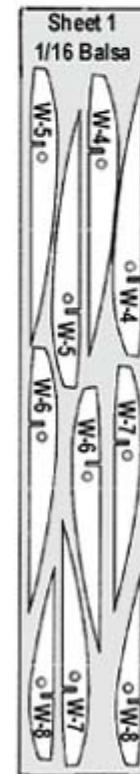
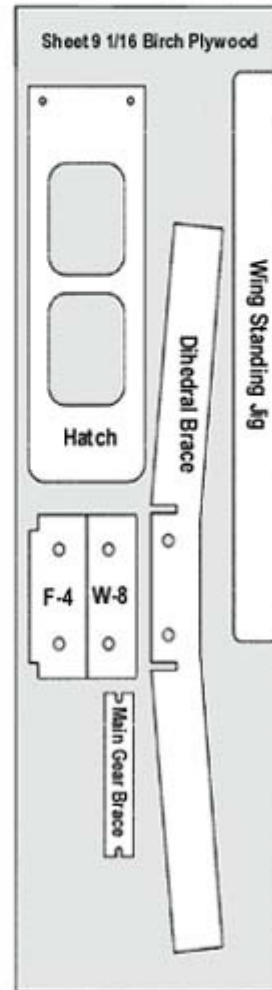
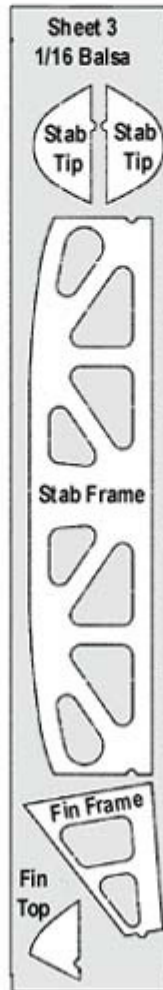
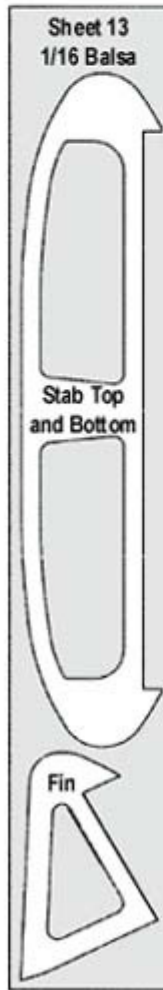
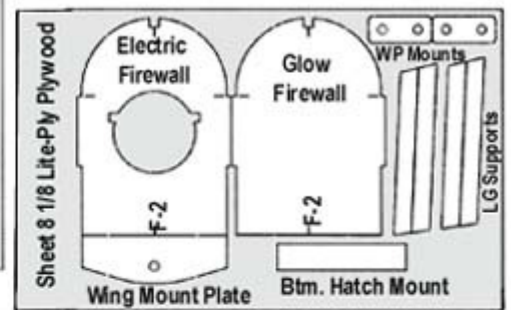
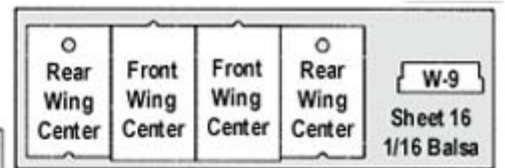
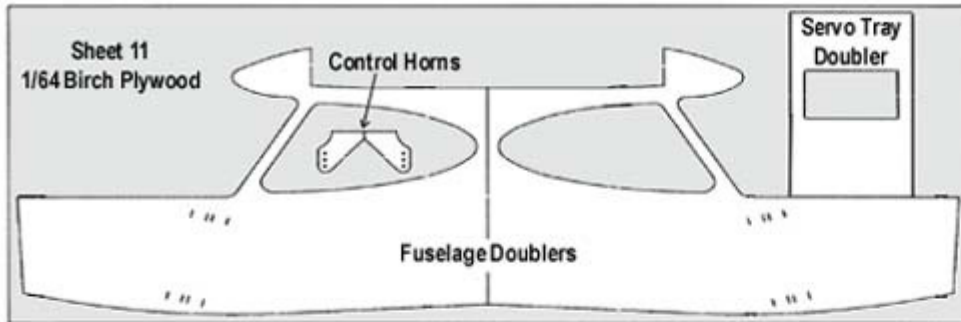

## Pre-Construction Notes

With the exception of the open structure on each fuselage side and the wing panels, there is really no need to build this airplane directly over the plans. But when building over the plans, be sure to protect them with waxed paper, the clear backing from covering film, etc. We built our R/C Rascals basically using SIG Thick CA glue. However, there are certain areas of construction that may require different adhesives. We will call these out in the appropriate instruction steps. You may notice that some laser cut parts have small notches along their edges. This is done on purpose to hold the part in the sheet. Use a hobby knife with a sharp #11 blade to remove the parts as needed. With scissors, remove the rear fuselage drawing from plan sheet No. 1. Use clear tape to join the rear plan to the front plan at the X lines. Let's begin.

## FUSELAGE CONSTRUCTION

1. The fuselage sides are made first. No matter how many times we say this, some builders always make the mistake of making either two right or two left fuselage sides!

However, we'll say it again -

### MAKE ONE RIGHT AND ONE LEFT FUSELAGE SIDE.

From your kit contents, locate the two laser cut 1/16" balsa fuselage sides and the two 1/64" plywood fuselage doublers. To give you time, use a slow setting adhesive to glue the plywood doublers in place to each fuselage side, aligning them carefully. Wipe off any excess glue and use pins or weights to hold the doublers firmly in place to the fuselage sides on your flat work surface until the glue sets.

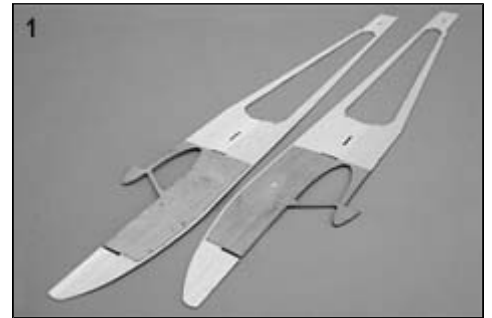

2. As shown on the plans, the fuselage sides are framed with 1/8" square balsa longerons. Pin the fuselage sides firmly to your flat work surface, with the doubler sides up. Starting with the bottom longeron, use CA glue to glue the longeron in place from the very rear of the fuselage forward to the front edge of the doubler. Pin the longeron in place as you go. Glue the top longeron in place next. As shown, this piece fits from the front face of F-6 back to the rear face of F-7. Next, glue the stabilizer longeron in place. This is cut to fit from the back face of F-7, back to the rear of the fuselage side.

The longeron that fits at the top of the fuselage, directly beneath the wing is now prepared. As you can see, this piece is glued to the top of the fuselage side and fits from F-6, forward to the bottom of the leading edge of the cabin. In order to make this piece fit flat to the fuselage side, you must relieve it slightly to fit flat against the fuselage doubler, forward of F-5. Use a sanding block to do this and glue the piece in place.

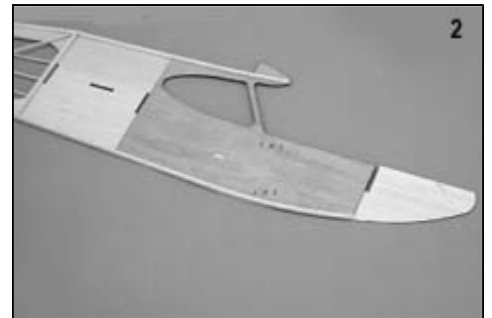

3. Cut, fit and glue the two 1/8" square balsa uprights in place that fit against the back face of F-6 and the front face of F-7. Hold the actual formers in place to the fuselage side when doing this to insure a perfect fit.
4. Cut, fit and glue the 1/16"x1/8" balsa uprights in place between the fuselage longerons at stations A and B on the plans - these are installed on the 1/16" edge. Cut, fit and glue the 1/16"x1/8" diagonal fuselage braces in place, from F-6 back to F-7, also on edge.
5. With the uprights and diagonal braces in place in each fuselage side, turn the sides over and cut, fit and glue the three 1/16" square stringers in place using the plans for placement reference. Cut, fit and glue a length of 1/16" sq. balsa to the center of the window frame support, as shown on the plans. Avoid using excess glue for this step. The exposed edges of the window frame will later be used to mount the front windshield and the side windows.
6. From your kit contents, locate the four 1/8" lite-ply laser-cut landing gear supports. As shown on the plans, these are glued directly to the fuselage doublers, using the tick marks provided for placement. The supports fit against the bottom fuselage longeron. Use thick CA glue and use the actual landing gear wire for exact spacing between the supports. Once these supports are glued in place, use your hobby knife to slot the bottom longerons, where the landing gear wire exits each fuselage side.

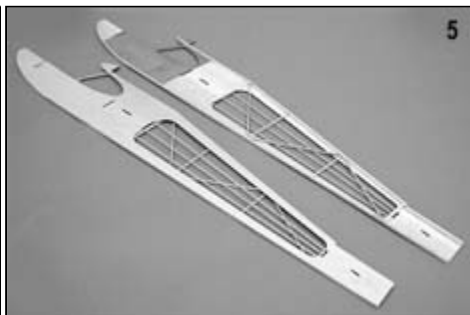

7. Remove the fuselage sides from your building surface. Clamp or tape the sides together, matching the outlines of each exactly. Use your sanding block to sand their outer edges to exactly the same outline, giving you two identical fuselage sides.

**OPTIONAL:** You will notice that our models have nice looking gray cabin interiors. We achieved this look using nothing more than light weight gray art paper, obtained from a local art supply store. We cut the paper to fit inside the cabin, from F-5, forward to the landing gear supports. We glued it in place with 3M Spray Adhesive. We also used this paper on the forward face of F-5. This is a great looking effect that weighs virtually nothing. Give it a try!

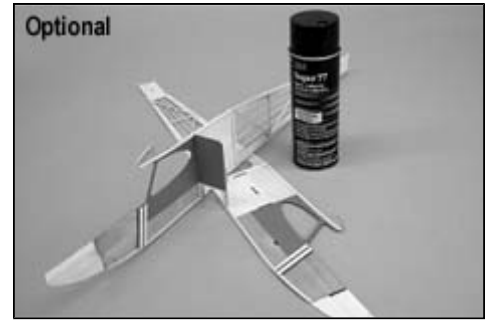

### **ELECTRIC or GLOW ENGINE?**

**At this point, you must decide which version of the Rascal you want to build - electric or glow. In the following steps we will identify procedures for both the electric and glow versions. Use only the steps and procedures that apply to the version you are building.**

8. Laminate 3/32" laser-cut balsa servo tray with 1/64" ply servo tray doubler - align edges accurately. Note that the servo opening in this tray assembly is cut to allow the servos to be mounted further forward, toward former F-5. Position your servos in place into the mount and mark their mounting holes with a pencil. Drill the servo mounting screw holes. Set the tray aside for later installation.



9. **Glow Engine Version:** Using the centerline tick marks on firewall F-2, use a pencil and a straightedge to lightly draw vertical and horizontal centerlines onto the former. Using these centerlines, accurately locate your motor mount to the firewall (DAVE BROWN #0506 is used for the Norvel .061). Mark the mount s hole locations on the firewall with a pencil. Use a 1/8" dia. drill bit to drill the four mounting holes through the firewall. Insert the four supplied 2-56 blind mounting nuts into the back face of the firewall and press firmly in place. Use a small amount of thick CA glue around the edges of the blind nuts to secure them.

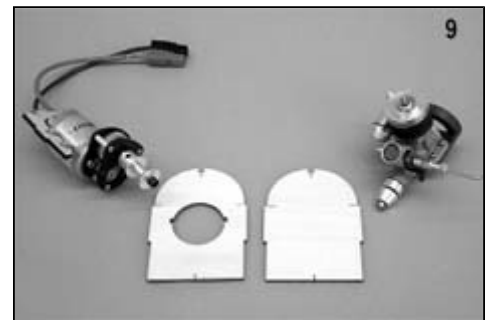

10. Mount the engine to the motor mount, using 2-56 bolts and locknuts (not supplied). Note that the engine should be mounted as far forward as possible on the mount.
11. The two vertical grain balsa engine compartment doublers (the pair without slots) are now glued in place to each fuselage side. Use the firewall to accurately align the rear edges of the doublers when gluing them in place - remove the firewall.



**Electric Version:** Install the fuselage nose doublers with the tab slots.

12. As shown on the plans, the glow engine version of the Rascal has a shorter nose. This is to allow for the Norvel .061 engine to be mounted in place with the correct propeller clearance. This requires that you now trim both fuselage sides to the shape shown on the plans for the Glow Engine version of this model. Use the plans as your guide, trimming and sanding both fuse sides identically.

**Electric Version:** No trimming of the fuselage sides is needed.

13. With the right fuselage side pinned flat to your work surface, glue the F-2 firewall and formers F-5 and F-6 in place. Use a 90 deg. triangle to make sure these formers are at true right angles to the fuselage side. The previously prepared servo tray is now glued in place to the right fuselage side, between F-5 and F-6. Apply glue to the right side of the servo tray, where it tabs into the right fuselage side. Glue it in place between but not to formers F-5 and F-6, again at 90 deg. upright.

**Electric Version:** The firewall for the electric version has a large hole in its center. Use this firewall for this step.

14. With the right fuselage side still flat on your work surface, test fit the left fuselage side in place onto the F-2 firewall, F-5, the servo tray and F-6. Each tab and slot should align easily and the structure should be square without misalignment. Remove the fuselage side and apply glue to the former and servo tray edges that will contact the fuselage side. Carefully reposition the fuselage side in place and use weights to hold it flat to the formers. Allow the structure to dry.

**Electric Version:** Before gluing the left fuselage side in place, you must prepare the laser-cut plywood electric motor mount for installation. Using the four mounting holes in the Maxx Products Clam Shell motor mount as a guide, mark their locations onto the plywood electric mount part. Drill these four holes with a 1/8" dia. drill bit. Press four 2-56 blind mounting nuts into each drilled hole, all the way to their bases. Use a little thick CA glue around their edges to secure them. As shown on the plans, the mount is installed with the blind nut bases on the top of the mount.

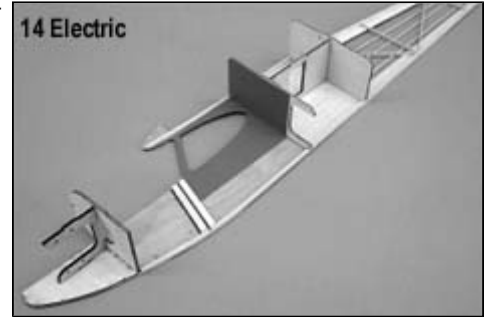

Glue the ply motor mount in place to the right fuselage side, with its tab in the nose doubler slot and its rear Tab engaged in the firewall slot. With the ply mount in place, apply glue to the motor mount, firewall, F-5, servo tray and F-6 parts. Carefully position the left fuselage side over each part. Make sure the fuselage side is fully seated to the parts and use weights to hold it securely in place.



15. Remove the fuselage from your work surface. Glue lasercut former F-4 in place at the top of the fuselage cabin, against the back of the cabin leading edge shapes and between the upper 1/8" sq. balsa longerons. Be sure to install this former squarely, making sure it is accurately in place.



16. Glue former F-3 in place at angle shown. Use the F-3 ANGLE GUIDE as a guide. This angle is important because it dictates the slope of the nose. Also note that when the wire landing gear is in place between the fuselage sides, its top edge is immediately in front of F-3.

**Electric Version:** Glue former F-1 in place between the fuselage sides, at front. F-1 should be vertically aligned with the fuselage sides in side view and square with fuselage in top view.

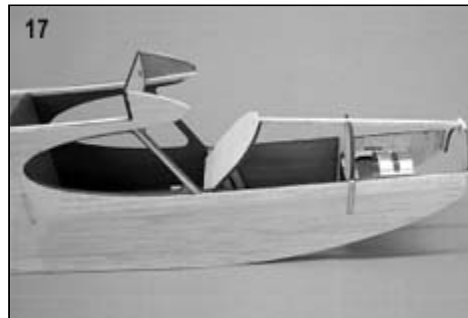

17. The top front 1/8" sq. balsa nose stringer is now installed. For the electric version, this stringer is cut to fit from the front face of F-1 back to the rear face of F-3. For the glow version, the stringer is cut to fit 1/4" front of the firewall, back to the rear face of F-3.

18. **Glow Version Only:** Assemble your fuel tank per the manufacturer's instructions. As shown on the plans, the fuel tank sits directly behind the firewall, as high as possible. It is supported in this position with two lengths of 3/16" sq. balsa, cut to fit snugly between the fuselage sides. Access to the tank, for installation and removal purposes, is through the bottom access hatch.



Cut and trim the two required pieces of 3/16" sq. balsa to support the tank. Set one of these aside for now for installation later. Holding the tank in position in the fuselage, glue the forward tank support in place. Install the engine and mount in place onto the firewall. Now you must plot your fuel line holes through the firewall.

We suggest using a simple two-line fuel system. As shown on the plans, we drilled these holes to allow for muffler clearance and for easy routing of the muffler pressure/overflow line (we used small diameter fuel tubing for the Norvel). Mark the locations of the two holes onto the firewall and remove the tank from the fuselage.



With the engine and mount still on the firewall, mark the location of the throttle tubing hole. This hole lines up with the hole in the engine's throttle arm and, in the case of the Norvel, is located on the far left side of the firewall. Remove the mount and engine from the firewall. Drill the two fuel line holes with a 5/32" dia. bit and use a 5/64" dia. drill bit for the throttle tubing hole. The throttle pushrod tube will be installed later in these instructions.

- 19a. Use the 1/16"x3" balsa sheet provided to cover the top front of the fuselage from F-3 forward, over the engine compartment to the front of the fuselage sides. This is most easily done using two pieces of wood, joined at the center, over the 1/8" sq. balsa stringer.

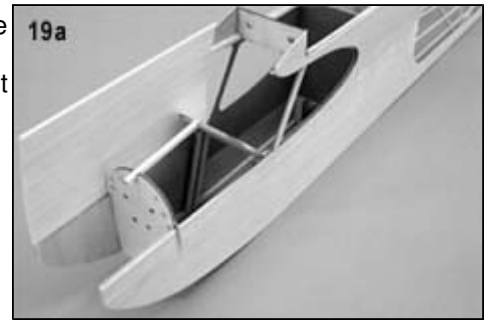

- b. Edge-glue the sheeting to the fuselage sides first. Then apply glue to the formers and roll the balsa sheet over them to the center of the 1/8" sq. stringer.

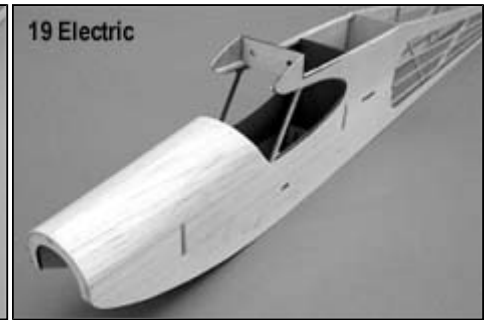
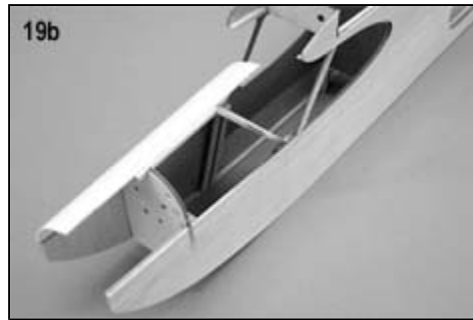

- c. Lightly sand each joint with a sanding block.

**Electric Version:** The 1/16" balsa nose sheeting is applied in exactly the same manner as the glow version. The sheeting covers F-1 back to F-3.

20. Glue the bottom 3/32" laser-cut balsa nose doubler in place between the fuselage nose doublers and against the bottom face of the firewall. The doubler fits flush with the fuselage sides with the half-circle drain hole cut out facing to the rear. When gluing this doubler in place, match the bottom curvature of the nose. Lightly sand the doubler and fuselage sides smooth.

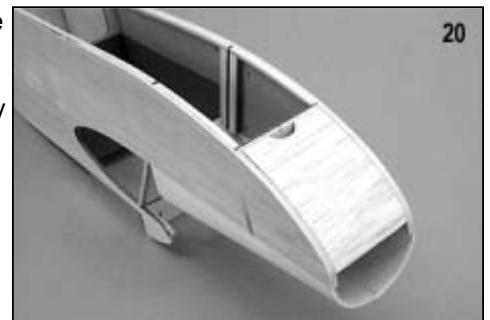

21. **Glow Version Only:** Use your Dremel Tool and drum sander bit to begin clearing out the top front sheeting to accept the engine and mount back to the firewall. As shown in the photo and on the plans, the sheeting is cleared enough to cleanly accept the engine and its muffler, with approximately 1/8" clearance all the way around. As you proceed, frequently check the fit until you are able to get the motor mount flat against the firewall. Note that the configuration of the Norvel engine and muffler leaves the muffler almost, but not quite, touching the firewall. This works fine in actual practice.

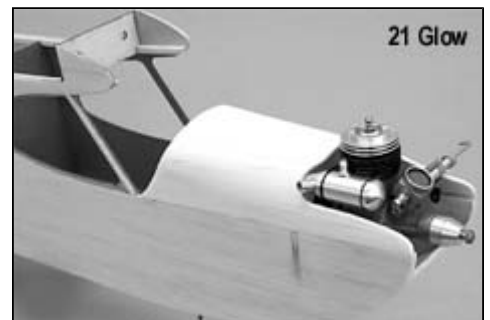

22. Locate laser-cut 1/16" plywood main landing gear brace. Lightly tack-glue the brace in place to the bottom of the fuselage, over the landing gear wire slots cut earlier into the bottom longerons. After final sanding of the fuselage, this brace will be removed, allowing you to mount and glue the landing gear in place in the fuselage. Only after the wire landing gear is in place, will the sanded landing gear brace be final-glued to the fuselage.



23. The bottom of the fuselage, from the front edge of the 1/16" plywood landing gear brace, forward to the nose is now sheeted, using the 1/16"x3"x36" balsawood sheet stock provided in your kit. As shown, this sheeting is applied in cross-grain. Glue sheeting in place but DO NOT glue the rear edge to the plywood landing gear brace. Lightly sand the sheeting edges smooth with the fuselage sides.

**Glow Version:** Use your hobby knife to clear out the bottom front sheeting, at the center front firewall location, to expose and match the half-circle drain hole in the bottom nose doubler. Use your Dremel Tool and a drum sanding bit to create the half-round shape in the front of the bottom sheeting, as shown on the plans. This shape allows the engine and mount to be more easily removed and installed.

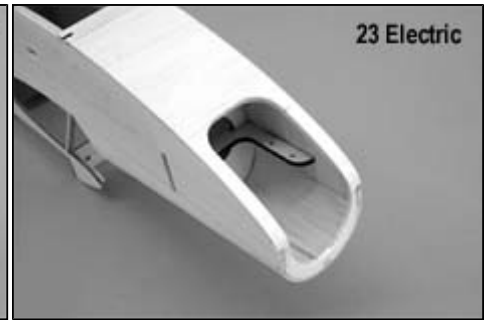
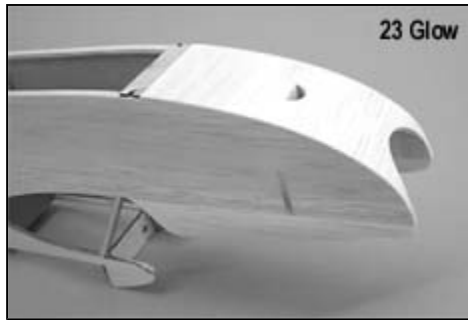

**Electric Version:** In order to mount and remove the motor/gear assembly, you will need access to the bottom front of the fuselage. As shown, we used a Dremel Tool and a drum sanding bit to shape a rectangular opening in the bottom front sheeting, with rounded corners. This opening extends back toward the firewall, far enough to allow a screwdriver to fit into the rear motor mount screw. Use a straight edge and soft pencil to draw the area to be removed directly onto the balsa.

24. From the laser-cut lite-ply parts, locate the hatch bolt plate. Trim the length of this piece to fit exactly in place at the bottom of the fuselage, between the longerons, just in front of former F-5. This part must be positioned so that it is 1/16" below the bottom edges of the fuselage sides. Use a scrap piece of 1/16" wood to position it correctly in the fuselage. Glue the part in place to the fuselage longerons and the bottom forward face of F-5.



25. The bottom access hatch is now made. Locate the lasercut plywood hatch stiffener, two #2 sheet metal screws and the 1/16"x3" balsa sheeting stock provided in your kit. Note that the plywood hatch stiffener fits between the fuselage longerons, just ahead of F-5. The front lip of the hatch stiffener has the rounded ends. The front of the hatch fits under the plywood landing gear brace and the rear of the hatch rests on the spruce hatch screw plate just installed.

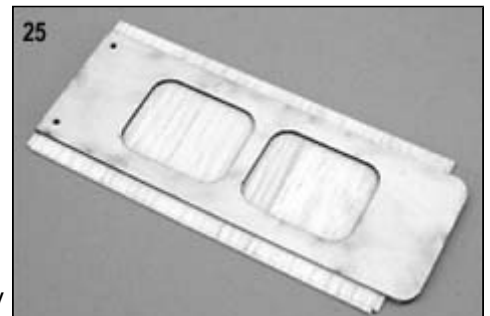

Start by positioning the ply hatch brace in place in the bottom of the fuselage - rounded ends beneath the ply landing gear brace and the rear (with the screw holes) directly over the spruce bolt plate, lined up with the front face of F-5. The ply hatch cover should fit easily without being forced. If it is a little too wide, lightly sand its sides to achieve a good fit. Use a sharp pencil to mark a line across the hatch brace, at the rear edge of the landing gear brace. Remove the hatch brace from the fuselage. The hatch brace is now sheeted - cross grain - using the 1/16" balsa stock. At the front, the balsa sheeting is aligned with the pencil mark just made. Leave about 1/4" of balsa on each side of the brace.



Turn the sheeted hatch over and use a 3/32" dia. drill bit to complete the two screw holes through the balsa sheet. Turn the hatch back over and use your Dremel-Tool and a small diameter grinding bit to clear the balsa around the two holes to accept the heads of the screws. Install the hatch in place into the bottom of the fuselage. The two guide holes for the hatch screws are now made through the hatch and the spruce screw plate - do this with a pin vise and a 1/16" dia. drill bit. The hatch can now be installed into the fuselage, using the two #2 screws provided.



Use the 1/16"x3" balsa sheet stock to cut, fit and glue cross-grain sheeting in place from the rear edge of the hatch, back to the center of former F-6. Use your sanding block to sand the edges of the hatch and bottom sheeting flush with the fuselage sides.

26. As shown on the plans, the center section of the wing is integrated into the fuselage structure. In the following steps, the center section will be built to fit perfectly to the fuselage. Later, when building the wing panels, having the center already built will be very convenient.

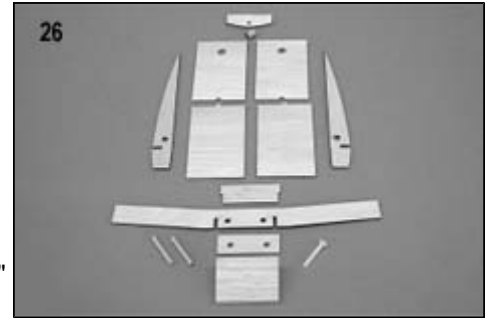

Start by locating the required laser-cut parts - 1/16" ply W-8 and the Dihedral Brace, the 1/8" lite ply wing bolt mounting plate and balsa parts W-1 ribs (2), W-9 and the four top and bottom laser-cut sheeting pieces. You also need the two 5/32" dia. x1-1/4" wing dowels, the 5/16" dia. x1/2" dowel with the drilled center hole, the 8-32 x1" nylon wing bolt and the shaped fuselage/wing block.

27. The top and bottom sheet parts are first glued together, making two complete pieces of sheeting - note that these are laser keyed to fit each other at the join line and that there is a laser-cut 5/16" dia. hole at the rear edge of both sheeting pieces. After gluing the sheets together, lightly sand the joints smooth. Test-fit the 1/8" lite ply wing bolt mounting plate in place beneath the top wing saddle longerons, against the front of F-6. The fit should be good but use a sanding block if needed to make it fit perfectly. Glue the bolt plate in place in the fuselage.



28. Insert the two 5/32" dia. forward wing dowels into the front of F-4, leaving about 1/8" of each exposed at the rear. Press ply former W-8 in place over the dowel ends, flat to the back face of F-4. Place one of the sheeting pieces in place on the top of the fuselage, with the lasered hole to the rear. Hold the sheeting firmly in place to W-8 and look at the hole at the rear of the sheet. It should be centered over the hole in the wing bolt mounting plate. If the hole in the sheet is too far back, trim the front of the sheet a little to move the hole forward. Use a little piece of waxed paper directly beneath W-8 to keep glue away from the fuselage. With the bottom sheet exactly in place over the top of the fuselage, glue the forward edge of the sheet to the bottom edge of W-8. Use a piece of tape at the rear to hold the sheet firmly in place.



29. Lay the fuselage on its right side, on a flat surface. Glue the right W-1 rib in place to the back face of W-8 and onto the right edge of the center section sheet. Turn the fuselage over and glue the left W-1 in place. Use your sanding block to lightly sand each W-1 rib flush with the fuselage sides.

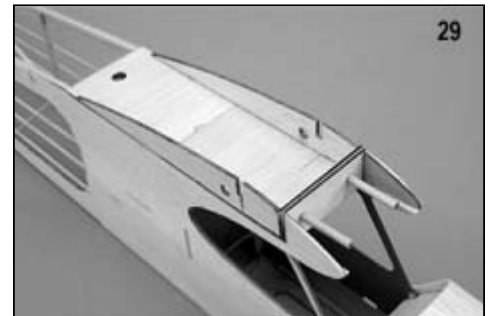

30. With the center section structure still on the fuselage, glue 1/16" ply dihedral brace in place at the front of the 1/8" slots in the W-1 ribs and onto the bottom sheeting. Glue the W-9 backup former in place directly behind dihedral brace.

Remove the two dowels from the fuselage and center section. Use your sanding block to chamfer the trailing edge bottom sheeting to receive the top sheeting. Insert the two 5/32"x1-1/4" wing dowels all the way through W-8 and into the holes in the dihedral brace. Glue the dowels in place.

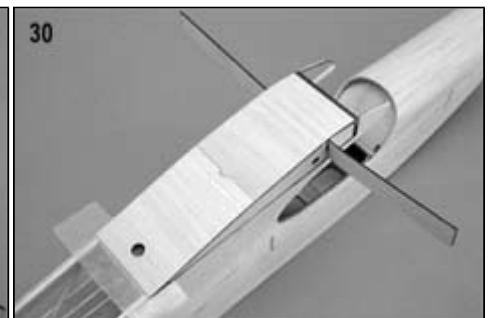

Mount the center section assembly to the fuselage, with a piece of wax paper beneath the trailing edge. Glue the top sheeting in place on the center section - align carefully, wiping off any excess glue.

31. Use 5-minute epoxy to now glue the 5/16" dia. piece of drilled dowel into the two holes at the rear of the center section. The hole in the dowel must line up with the hole in the 1/8" ply wing bolt plate in the fuselage. Remove the center section from the fuselage and use an 8-32 tap to thread the hole in the wing bolt plate (make sure to angle the tap to match the top curvature of the airfoiled center section). Use thin CA glue to harden the threads and re-tap them. Test the threads with the 8-32 nylon bolt in your kit.

When the epoxy has set, use a sanding block to sand the dowel smooth with the top and bottom surfaces of the center section. Mount the center section in place onto the fuselage and test the wing bolt. Make any adjustments necessary to create a good fit. Remove the center section from the fuselage.



32. From your kit, locate the shaped center section leading edge balsa block (5/16"x3/4"x1-5/16"x2"). Lightly sand the sides of this block until it fits easily between the fuselage sides, up against F-4. The fit should be snug, without being forced in place. With the block in place, use a pencil to mark the wing dowel holes onto the backside of the block, through F-4. Remove the block and use your Dremel Tool and small grinding bit to relieve the two hole locations, allowing the wing dowels to clear when the center section is in place. Test the fit of the block with the center section in place. The leading edge block is now glued in place.



33. Mount the wing center section to the fuselage and use your sanding block to lightly sand the leading edge block smooth, matching its shape to the fuselage sides at the front and its top surface smooth with the leading edge of the center section. Don't worry about final sanding at this stage, just sand the parts to match. Remove the completed center section and set it aside for wing assembly.

34. Without using glue, fit former F-7 in place at the rear of the fuselage - use a little tape or a clamp to keep the fuselage sides firmly against the sides of F-7. Use a double-sided sanding block (a simple piece of scrap 1/16" ply or hard balsa sheet with 220 sandpaper on both sides works perfectly) to sand the rear fuselage longerons uniformly, allowing the two fuselage sides to touch.

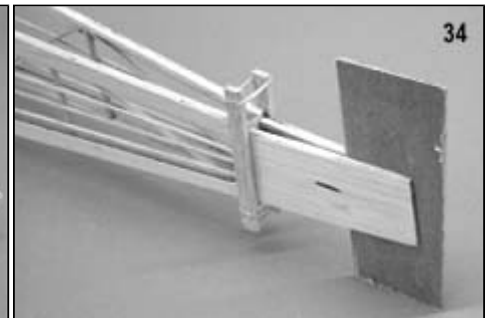
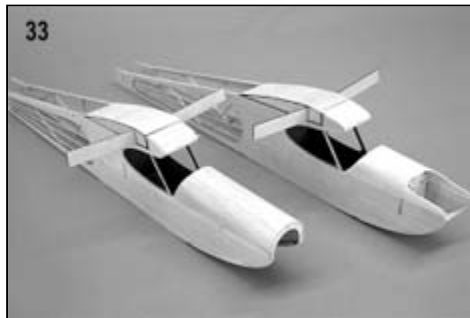

Once the longerons are sanded, remove F-7. Mix a small amount of 5-minute epoxy and carefully glue F-7 in place to one of the fuselage sides. Apply glue sparingly to the sanded top and bottom longerons, the very end of the fuselage side and to the opposite side of F-7. Pull the fuselage sides together, fitting F-7 in place and holding the two fuselage sides together squarely at the very rear. Use a little tape or a simple clamp to hold the structure together and allow the glue to set.

35. In this step you will install the two female rudder and elevator pushrod tubes. The technique is easy if you follow these instructions. First, note that these two tubes extend into the servo compartment about 1". They pass through the laser-cut holes in F-6, back through the fuselage, through F-7 and exit through the laser cut holes in the rear of each fuselage side, just beneath the stabilizer. The nice thing about this set-up is that the tubes are anchored, inside the rear of the fuselage, at each upright and diagonal brace, immediately behind the top 1/16" stringer. This makes them virtually invisible when you choose to cover this open area with transparent coverings.

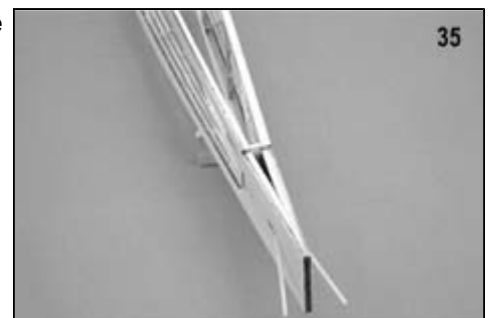

Use 220 sandpaper to lightly sand the outer surface of both tubes. This allows them to be securely glued, using thick CA glue. As shown on the plans, the rear ends of the tubes exit the fuselage at severe angles. It is easiest to pre-cut these angles before installing the tubes - do this now.

Insert the untrimmed end of one of the tubes into the rear exit hole and use a piece of wire or small dowel to guide it through the opening lasered into F-7. Continue feeding the tube into the fuselage all the way to F-6. Feed the tube through the hole in F-6. From the servo compartment, carefully pull the tubing forward until the angle-cut end of the tubing nests into the rear exit slot at the back of the fuselage. Once the tube is in this position, you can begin gluing it in place.

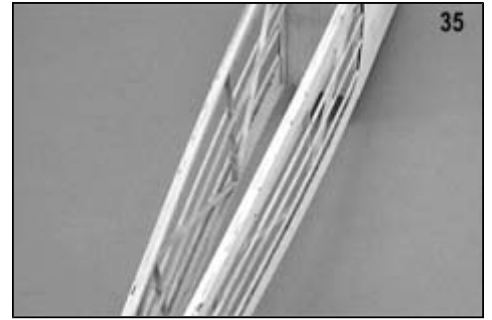

The technique we use for gluing the tube at the various stations is to put a little puddle of thick CA on a piece of waxed paper. Then use a length of small dia. dowel with one end sanded to a dull point, for use as an applicator. Start gluing the tube in place at the rear of the fuselage. Use a scrap piece of stickwood to hold the tube against its exit point in F-7 and apply a small amount of glue to hold it there. Move forward to the rearmost diagonal and move the tube a little to let you apply a small dot of glue to the inside edge of the diagonal, just behind the top stringer. Hold the tube in place to the glue to adhere it. Move forward to the rearmost upright and repeat this procedure, again making sure the tube is directly behind the top stringer.

In this manner glue the tube in place to the remaining uprights and diagonals until you get to F-6. Apply a little glue to the tube, where it enters the hole into the servo compartment. Repeat this procedure with the opposite pushrod tube. When both tubes are installed, go back over each glue joint with the dowel applicator and apply a small amount of glue to each joint, making sure the tube is secure - use glue sparingly. Use scissors to reach inside the servo compartment to trim the tubes to a length of about 1" ahead of the front of F-6. Use your sanding block to lightly sand the fuselage sides, where the tubes exit.

36. Use the 1/16"x1/8" balsa stock to now cut and glue in place the top and bottom cross-braces at fuselage stations A and B on your plans. Cut these braces to fit easily, without bowing out the fuselage sides and be sure that they are identical length for both the top and bottom. This keeps the fuselage square. Use your sanding block to lightly smooth the top and bottom of the fuselage over these cross-braces.

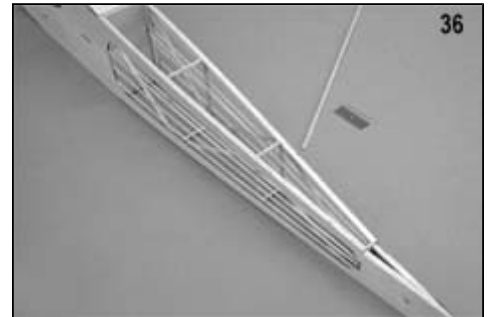

37. The top and bottom rear 1/16" balsa sheeting is now installed. Note that this sheeting is applied with the grain running front to rear - not cross-grain. We suggest installing the wing center section assembly, protecting its rear edge with a bit of wax paper. This gives you an accurate front edge location for the top sheet. Simply lay the balsa sheet in place and trace the fuselage outline onto it with a pencil. Cut the sheet out using a sharp #11 blade. The sheet is then glued in place. After attaching both the top and bottom pieces, remove the wing center section and use your sanding block to lightly smooth the sheeting edges smooth to the fuselage sides. Also, lightly sand the rear edge of the top sheeting to match the stabilizer leading edge notch.

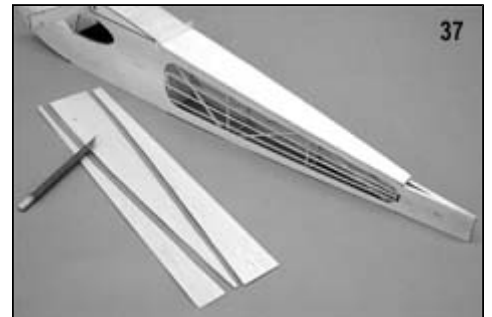

38. The completed fuselage is now sanded to shape. As shown on the plans, the fuselage corners are sanded round for a pleasant, believable look. Don't overdo it but strive for a uniform overall look. NOTE - When sanding the fuselage at the bottom plywood landing gear brace location, take care to round this uniformly, along with the balsawood immediately in front and back of the brace.

39. Locate the printed color instrument panel from the kit contents. Use scissors to trim the panel around its outer edge. Trial-fit the panel in place against F-3. Trim as needed for a good fit. The panel is now glued in place to F-3. You can use an adhesive such as 3-M Super 77 Spray Adhesive.



## WING CONSTRUCTION

**IMPORTANT NOTE:** Refer to the KEY TO LASER-CUT BALSA PARTS to find the correct TOP and BOTTOM wing sheeting pieces. You will assemble two TOP and two BOTTOM wing sheets. It is important that you understand this.

40. Assemble both right and left top and bottom wing panel sheeting skins, including the center section sheets. Start by gluing the front and rear center section sheets together to make a single piece. Glue the leading edge of the center sheet piece to the rear edge of the leading edge. Now glue the curved trailing edge piece to the rear edge of the leading edge, at the wing tip. Finally, glue the rear of the center section piece to the front edge of the trailing edge sheet. Once the sheet is assembled, use a flat sanding block, with 220 sandpaper, to lightly sand the top and bottom smooth at the glue joints.
- 41a. The two shaped  $5/32 \times 5/16 \times 24$ " leading edges are now trimmed to match the tip shape, using the laser cut wing spar as a guide. Hold the spar against the back face of the leading edge, as shown, and use a pencil to trace the bottom tip edge of the spar onto the leading edge.
- b. Use a sanding block to sand the end of the leading edge to match the line just drawn. Do this to both leading edge pieces.

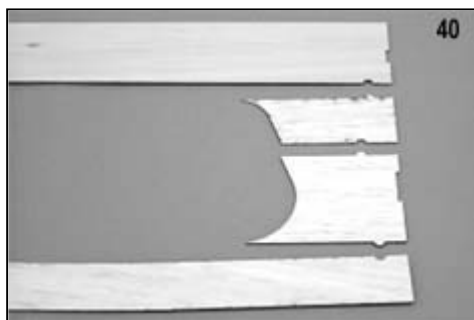

42. Position and pin bottom wing sheet assembly in place over plans. Cut, fit and glue the  $1/16 \times 1/4$ " balsa cap strips in place between the leading and trailing sheets at each rib station. Locate the laser-cut  $1/16$ " sheet balsa spars from your kit contents. As shown on the plans, the spar is glued in place over the back edge of the forward wing sheeting. Apply glue to the bottom edge of the spar all the way out to the outer W-8 rib location - do not apply glue past this point. Accurately position the spar in place, making sure it is 90 deg. upright. Pin in place.

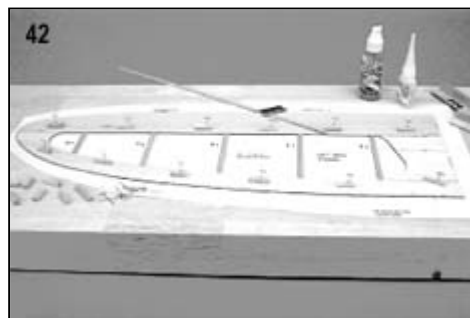

43. Note that the wing root ribs are lasered into two parts: W-2 and W-2A. Separate these parts with a razor blade. Position the already built wing center section in place against the inboard edge of the bottom wing panel sheet. Hold the plywood dihedral brace arm firmly against the front face of the wing spar with a clamp or clothespin. The center section assembly will be off the work surface when the dihedral brace arm is clamped in this position. Apply a small bead of thick CA glue to the bottom of W-2 and glue it in place to the bottom edge of the wing sheet and the inboard end of the spar. Hold W-2 in place against the center section to provide it with the correct dihedral angle. When the glue sets, remove the center section.



- 44a. Slip a length of  $1/8$ " sq. scrap balsa directly underneath the wing sheeting at the leading edge. This provides the sheeting with the correct bottom leading edge curvature to match the wing ribs and supports it when the leading edge is installed.



- b. Starting with wing rib W-3, carefully glue each wing rib in place over the spar and onto the bottom wing sheeting. Be sure each rib is centered on its cap strip and is in complete contact with the bottom sheeting and cap strip. With all ribs glued and pinned in place, again position the center section structure in place as before, with the dihedral brace arm clamped to the spar. Glue the forward half-rib W-2A in place to the bottom leading edge sheet only - not the dihedral brace. Make sure W-2A is against the center section to give it the correct dihedral angle - avoid getting glue on the center section. With W-2A in place, remove the center section.

45. The bottom wing sheeting, at the tip, must now be shimmed up from the work surface to meet and match the bottom curvature of the spar. Your kit contains a bag of tapered balsa shims for this purpose. As shown, three shims are placed under the sheeting, directly beneath the spar tip location. Slide the shims in place and observe the sheeting as it curves upwards to meet the bottom of the spar tip.

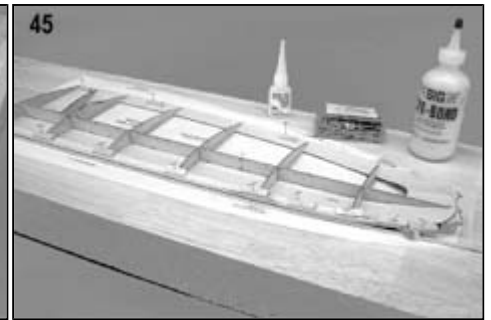
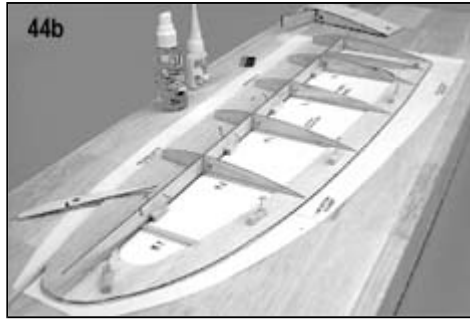

Remove the shims and apply glue to the bottom sheeting, from W-8 out to the tip, where it will contact the spar. Again slide the shims in place to bring the sheet up to the bottom of the spar-pin the shims securely to your building board.

46. With the wing now firmly positioned in place on your building board, the previously prepared leading edge is now glued in place to the bottom sheeting and to the front edge of each wing rib. Use a slower setting glue for this step to give you reasonable working time. Note that the leading edge fits in place straight until wing rib W-6. At W-6 the leading edge begins to bend back to match the leading edge curvature of the wing. As the leading edge is pulled back in place, its outer sanded surface should fit nicely to the bottom sheeting at the tip. Pin the leading edge securely and allow the glue to set.



47. Remove the wing panels from the building surface. Use your large sanding block to lightly chamfer the wing tip and trailing edges of the bottom wing sheeting to accept the top wing sheeting. Use your sanding block to also lightly sand the top of leading edge top smooth matching its rear edge flush with the tops of each rib. Do not sand the outer edges of the panels at this time. This will be done after the top sheeting is in place. Once both panels are prepared, cover your work surface with waxed paper and lay the panels back down.



**MODELER'S TIP:** When using a sanding block over exposed ribs, spars, etc., it is possible to mistakenly sand these parts, perhaps changing the airfoil or causing dips in the top sheeting. It is easy to protect these parts by simply using masking tape to cover them before sanding. Once the panel is sanded, remove the tape. The result will be no damage to the ribs.



- 48a. Pin the wing panels securely to your building board - as shown, use pieces of scrap stick stock to pin the panels from the back side of the wing spar. Do not use pins over any areas where the top sheeting will be glued in place. As before, slip 1/8" square balsa stock just beneath the bottom of the leading edge to support it and again use the supplied shims to support the wing tip at the spar location.

With the wing panel firmly weighted or pinned to your work surface, use the rest of the tapered balsa shims to begin raising the trailing edge of the wing, beginning at a point between W-7 and W-8. The goal is to smoothly shim the trailing edge tip portion of the wing panel just enough to raise it about 1/8" at the W-8 rib. This is called wash-out and is important to the flying characteristics of this model.



- b. Slip a few pieces of waxed paper between the shims and the wing panels to protect them from glue. Using a slower drying glue, such as SIG-BOND aliphatic resin, apply a thin bead of glue to the tops of each rib, ahead of the spar, to the rear edges of the ribs, where the sheeting will rest and to the top of the spar and to the top of the leading edge. Last, apply a bead of glue all around the edges of the bottom sheeting. Carefully lay the top sheeting assembly in place, aligning its inside edge with the spar top. Check the fit all the way around before pinning it in place. Use pieces of scrap stick stock and pins to firmly hold the leading edge in place. Work your way around the edges of the wing sheeting, using pins to secure it to the bottom sheeting. On the top of the wing, over the spar, use small weights or pins to hold the sheeting firmly in place. Allow the glue to dry completely.

49. Remove the pins, weights, etc. from the wing panels. But leave them pinned in place using just the pins and blocks through the back of the spar. With the 1/16"x1/4" balsa stock provided, cut, fit and glue the top cap strips in place onto each exposed rib. Remove the wing panels from your building board.

50a. Use masking tape to hold the two panels together, with their bottom surfaces aligned with one another. Use your sanding block with 220 sandpaper to now sand the outside edges of the joined panels together as one unit. This ensures that they are as close to identical as possible. As shown, sand the panel leading edges flat. With the two panels now match-sanded in outline, remove the masking tape and separate them.



b. With the panels now separated, the trailing edges of each panel, at the tips are now sanded to the nice looking taper shown. This is easy to do, using your sanding block and 220 grit sandpaper. This is a nice looking aspect to this airplane, so take your time and do a smooth job.

c. Because it is important to be able to sand and shape both panels identically, we have provided you with a laser-cut 1/16" plywood temporary wing sanding jig. Locate this part now from your kit contents. Insert one end of this fixture into the dihedral brace slot in one of the wing panels. Now slip the other panel in place over the exposed end and push both panels together until they touch. Place this assembly on a flat surface and use masking tape to hold the panels together at the center. You can now use your long sanding block and 220 sandpaper to lightly sand the top and bottom of the wing panels to identical top and bottom curvatures. Take your time, making sure the complete top and bottom of each panel is sanded smooth. Do not sand the tips and the trailing edges too finely. As shown, after sanding these should be typically a uniform 1/16" - 3/32" thick. The leading edges of both panels can now be sanded to uniform shape. We used a small razor plane to take the leading edges down more quickly, followed by a long sanding block for the final shape. After sanding, remove the tape and the plywood sanding fixture.

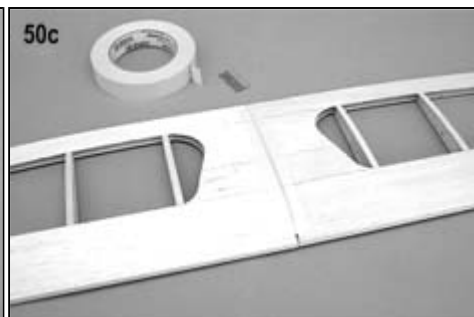
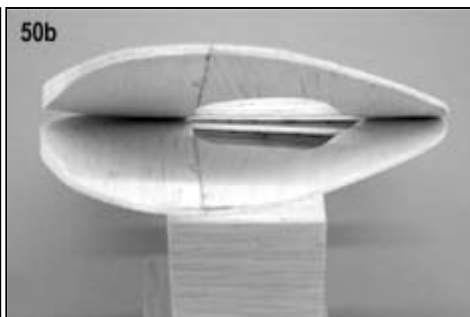

51. With the wing panels finished and sanded, they are ready to be joined to the center section. Trial fit the panels to the center section dihedral brace ends. The panels should fit snugly against the sides of the center section. Inspect the two matching airfoil curves of the center section and it's mating wing panel. If there are any variances between the two airfoil curves, use your sanding block to lightly match them. When the panels fit nicely, they can be glued in place to the center section.



For maximum strength and working time, use a slower drying adhesive for joining the panels. Glues such as 30-minute epoxy or SIG-BOND aliphatic resin are perfect for the job. Be sure to wipe off any excess glue and tape the panels securely in place, allowing the glue to set. The dihedral angle for both panels is already established by the dihedral brace.

52. Inspect the completed wing structure. Lightly sand as needed to make it smooth and ready to cover. Trial fit the wing onto the fuselage. Note that the forward inboard wing panel roots fit between the fuselage sides, above the forward cabin. These inboard ends may require a little light sanding to give them clearance - do this now. Try the wing bolt, making sure it engages the bolt plate and make any adjustments needed to seat the wing neatly.





## Tail Surfaces

As shown on the plans, the horizontal stabilizer and vertical fin are constructed as laminates. This allows them to be made from fairly light stock without sacrificing strength and rigidity.

53. Build the vertical fin first. From the contents of your kit, locate laser-cut vertical fin parts VF-1, VF-2, both outer fin sheets and the 1/16"x1/2"x6" leading edge stock. Glue VF-2 to the top of VF-1. Glue the 1/16"x1/2"x6" leading edge piece to the front of the VF-1/VF-2 assembly.



Lightly sand both sides of this assembly smooth. Apply glue to the inside surface of one of the outer fin sheets and glue it to one side of the VF-1/VF-2 assembly, aligning accurately. Glue the remaining outer fin sheet to the other side. Weight or pin this assembly on a flat surface until the glue sets. Lightly sand both sides of the completed vertical fin. Trim and sand the leading edge to match the shape of the two outer fin sheets.

Finally, sand the outer edges of the fin, making them flat and square - these will be rounded later. Fin/fuselage fairing VF-3 is now glued in place to the bottom front edge of the fin assembly.

- 54a. The horizontal stabilizer and elevators are now built. From your kit parts, locate laser-cut parts S-1, S-2 (2) and both the front and rear stabilizer cap sheets. You will also need both elevators and the 3/16" dia. x3" elevator joiner dowel.
- b. Use thick CA to glue the two S-2 tips to each end of S-1. Lightly sand the glue seams smooth. Assemble the rear stabilizer cap sheet part to the front cap sheet part. This is easiest to do in three steps. First glue the centers together. Then glue the parts together at one tip, followed by gluing the remaining tip together. Lightly sand the glue seams smooth. The stab parts are now ready for assembly.

Because CA glue is too quick for this step, we suggest a slower adhesive such as SIG-BOND. Apply glue to one side of one of the stabilizer cap sheets and position it in place against the S-1/S-2 core. Use pins or weights to keep this assembly flat against your work surface. After a little while, apply glue to the remaining cap sheet and position it in place against the opposite side of the stabilizer assembly. Pin or weight the stab to a flat surface and allow to dry completely.

55. Using the 1/16 x 1/18 balsa stock provided, cut, fit and glue the cap strips in place onto the left and right sides of the stabilizer. Turn the stabilizer over and glue the remaining cap strips in place. Using the same cap strip stock, cut and glue the two required cap strips on each side of the vertical fin.

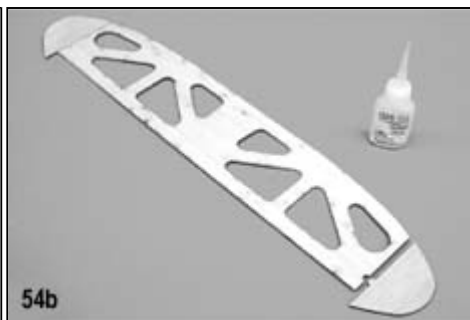
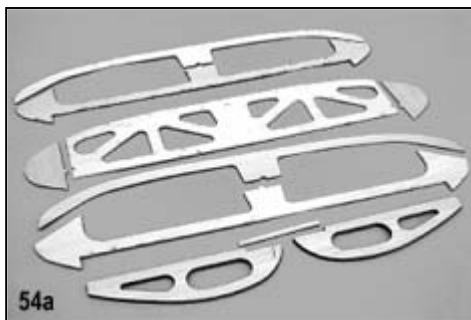

56. The elevators are now joined, using the 3/16"x3" dowel provided in your kit. Use epoxy for this job, being sure to line-up the leading edges of the elevators with a straight edge. Allow the glue to cure.
57. Use masking tape to attach the rudder in place to the fin, as it would be mounted when the model is done - use tape on one side only. Likewise, use masking tape to attach the elevators to the stabilizer, using tape on only one side. Turn these surfaces over on a flat surface and use a large sanding block with 220 grit sandpaper to sand the untaped sides smooth. Apply tape to the sanded sides, turn the parts over, remove the tape and sand those sides smooth.

The fin and rudder and the horizontal stabilizer and elevators are now sanded to uniform shape. We suggest that you take the extra effort to sand airfoil shapes into these surfaces. Use 220 grit sandpaper for final sanding. We suggest using a sharp #11 blade and your hobby knife to first whittle these surfaces to rough shape. This saves sanding time!

58. The leading edges of the rudder and elevators are now sanded to shape to allow movement when hinged in place. As shown on the plans, these leading edges are double beveled to the centerline, allowing up and down and right and left movement. After beveling, the elevators and rudder are pre-hinged to the stabilizer and fin. Using the hinge locations shown on the plans, mark the locations of each hinge position on the elevators and stab and the fin and rudder with a soft lead pencil. Use your hobby knife and a sharp #11 blade to make each necessary slot for the hinges. Pre-fit the hinges and flying surfaces to the fin and stabilizer, making sure the fit is correct. When satisfied, remove the hinges and separate the parts for covering and assembly.

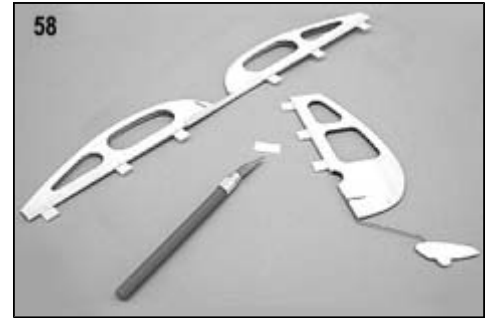

59. The tailwheel/wheel pant assembly is now made. Locate the pre-bent tailwheel wire and the two laser cut balsawood wheel pants from your kit contents. As shown, the tailwheel wire is sandwiched between the two wheel pant halves, using 5-minute epoxy. When the glue cures, use a sharp #11 blade and your hobby knife to shape the wheel pant to rough shape. Use 220 grit sandpaper to smooth the wheel pant to final shape. Note that we also filled-in the half-wheel of the tailwheel wire with a scrap piece of 1/16" balsa. Later, when the wheel pant was finished, we painted this half-wheel flat black, simulating a tire.

- 60a. The tailwheel wire is now mounted to the rudder. As shown, the rudder end of the tailskid wire is glued into the bottom, leading edge of the rudder. From the contents of your kit, locate the 1/2" length of 1/16" OD aluminum tubing. This length of tubing will be glued into the rudder to receive and hold the top part of the tail skid wire. Use a 1/16" dia. drill bit to drill a guide hole into the leading edge of the rudder, about 9/16" deep.



- b. Coat the outside surface of the tubing with 5-minute epoxy and use a toothpick to install the tubing fully into the drilled hole. Use a single edge razor blade to cut a shallow channel, from the tubing hole down to the bottom of the rudder - this channel locates the tail skid wire vertically to the rudder. Test-fit the tailskid wire in place. It should fit perfectly flush with the leading edge of the rudder. Once satisfied, use 5-minute epoxy to glue the tailskid wire in place into the tubing and channel and allow the glue to cure.



61. Locate the two laser cut 1/64 th plywood rudder and elevator control horns. These will not be glued in place until the radio system is installed. However, now is the time to trim them to fit in the rudder and elevator slots. Use a sharp pair of scissors to trim them to fit perfectly in place. Afterwards, use a bit of tape to identify them as the rudder and elevator horns for reference.

## Mounting The Tail Group

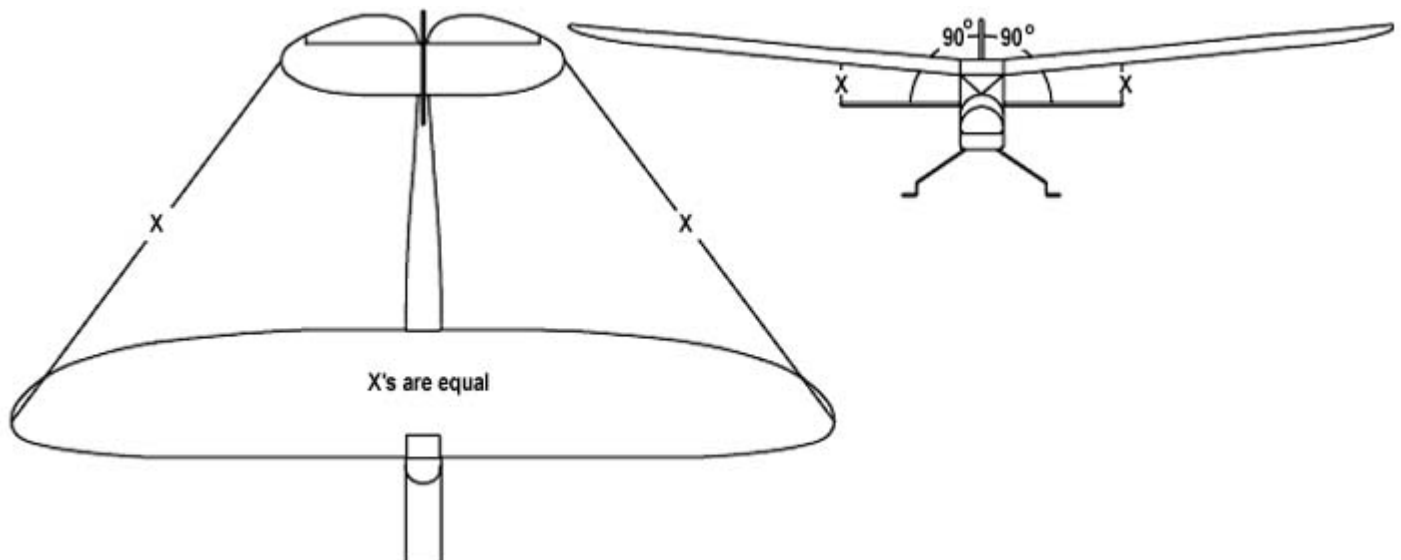

62. With all parts now sanded, install the wing to the fuselage using the nylon bolt. Set the airplane on a flat surface and make sure the stabilizer will sit squarely in place in the top view as well as the front view. Glue the horizontal stabilizer in place at the rear of the fuselage, using slow drying glue. Use pins or weights to hold it in this position and allow the glue to dry completely.
63. The vertical fin is next. Apply slow drying glue to the bottom of the fin and glue it in place directly over the top center of the stabilizer and fuselage. Adjust the fin as needed to be sure it is perfectly vertical and is aligned along the fuselage centerline in the top view. Use pins and tape to hold it in place until the glue dries.
- 64a. OPTIONAL: Locate the 1/4"x24" triangle stock from your kit contents. This stock is included if you wish to reinforce the fin/stab and stab/fuselage joints. We have built and flown Rascals without this reinforcement but many modelers like this arrangement. We also used this material for reinforcement purposes but we always sand it first to create a fillet effect, eliminating the need for excess filler. To make these cove-sanded fillets, start by using a Dremel Tool and a 1/2 round sanding bit to first create a trough along the centered length of the triangle stock.
- b. Follow this by wrapping a piece of 220-grit sandpaper around a length of 3/8" dia. dowel. Hold the triangle stock in place against the sandpaper and dowel and move it back and forth, sanding a smooth half-round shape in the balsa.
- c. This stock is now cut to length and glued in place to each side of the fin and stab on top and the stab/fuselage joints on the bottom. To finish these fillets, use Model Magic to fill-in the fillets and sand the whole thing smooth. Done right, these fillets look professional and are very light.

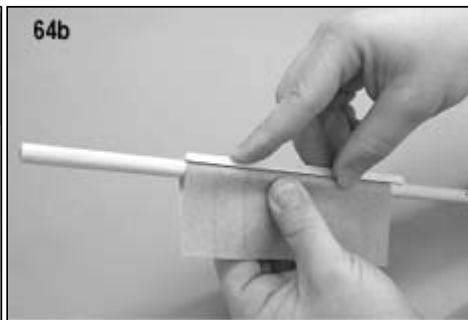
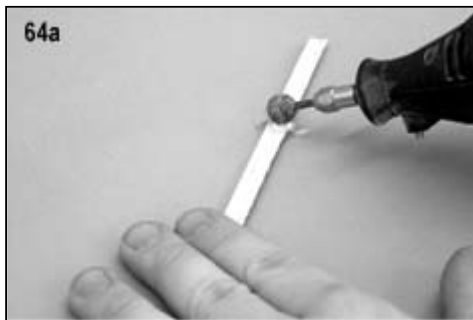

## Landing Gear And Wheel Pants

- 65a. Remove the two screws holding the bottom access hatch in place on the fuselage. Use your hobby knife to carefully remove the tack-glued plywood landing gear brace from the fuselage.
- b. From your kit contents, locate the four (4) plastic wheel pant halves, four 2-56 x1/2" bolts, four 2-56 blind mounting nuts, two nylon landing gear mounts and two laser-cut plywood wheel pant mounts. You will also need the pre-formed 3/32" dia. music wire landing gear. Finally, you will also need a set of Williams Bros. 1-7/8" dia. Golden Age style wheels (part number 150). These are the parts required to build the landing gear system.
- c. First, the wheel axle holes must be drilled out to accept the 3/32" landing gear wire. We used a #39 index drill bit (.0995 ) to do this. A drill press is best but it can be done without one if you're careful. As shown on the plans, the wheels extend exactly 5/8" below the bottom edge of the wheel pants. Lay a wheel over one of the pant halves, with 5/8" extending from the bottom of the pant - use a piece of tape as a simple visual guide. With the wheel in this position, insert a 3/32" dia. drill bit through the wheel and against the inside of the wheel pant. Twist the drill a few times, leaving a mark on the pant. Remove the wheel and use the 3/32" drill bit to drill a hole through the pant, at the mark just made. Repeat this process on the opposite wheel pant half.

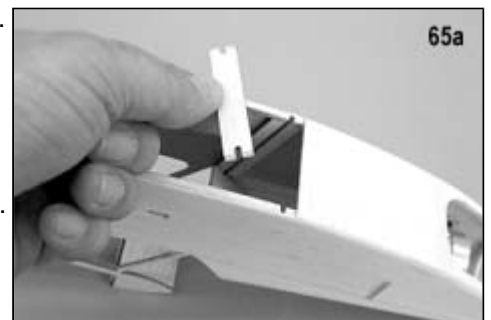

66. Slip the inside wheel pant halves onto each landing gear axle and then slip the wheels in place, up against the pant halves. Use a marker pen to mark the front and rear edges of the wheels. Remove the wheels and pant halves from the axles. Use a Dremel Tool and a tapered sanding bit to now clear out the bottom of the pant halves, allowing the wheels to fit in place against it's inside face. Test fit the pant halves and wheels to be sure of a good fit.

67. Insert two #2-56 blind mounting nuts into the holes in the laser-cut plywood wheel pant mounts. Press the nuts firmly into the plywood until their heads contact the wood. Use a little thick CA glue around their edges to keep them in place. As shown, the blind nut/plywood assembly will be glued to the inside surface of the inner wheel pant half. To correctly locate it's position, you must first drill the holes in the inner pant half for the #2-56 x1/2" mounting bolts. Slip one of the molded nylon landing gear mounts over the landing gear wire. Place the inner pant half over the landing gear axle, up against the upright part of the wire. Attach the same parts to the opposite axle. Use blocks or supports to prop up the fuselage on your work surface until it is level. The wheel pant halves should be resting flat on the work surface. With the airplane in this position, the location of the two holes required in each wheel pant half can now be made using a sharp pencil. Remove the pant halves and use a 3/32" dia. drill bit to drill the holes at the marks.

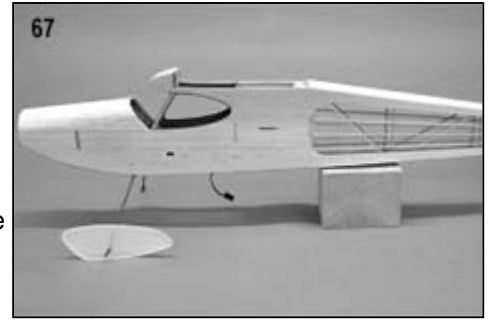

68. Because the bolts are too long to allow free movement of the wheel within the wheel pant they must be cut to the right length. Simply insert the bolts through the nylon landing gear clip and through the wheel pant holes just drilled. Using a screwdriver, thread the bolts into the blind nuts, mounted in the plywood pant mount. Use a Dremel Tool with a carbide cut-off wheel to cut-off the exposed ends of the bolts, flush with the blind mounting nuts. Remove the bolts. Apply a little 5-minute epoxy to the inside face of the plywood pant mount but keep the glue away from the threads in the blind nuts.

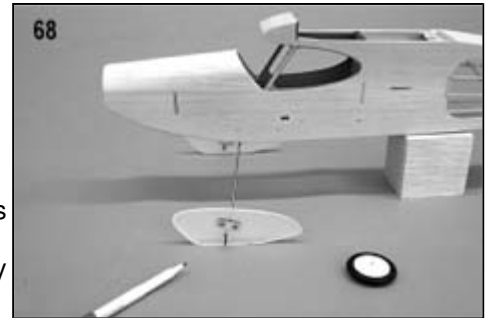

Re-insert the bolts through the nylon landing gear mount and through the two holes in the inner wheel pant. Use your screwdriver to engage the blind nuts with the bolts, tightening the plywood pant mount in place against the inside surface of the wheel pant half. Let the glue cure before removing the bolts.

69a. The outer pant halves can be glued in place to their corresponding inner halves. Apply thick CA glue around the edge of the inner pant half and carefully align and hold it in place to the outer half. Have a few small pieces of masking tape handy to help hold everything in position.

b. Once the pant halves are joined, use a tapered sanding bit in your Dremel Tool to open up the bottom of the outer pant half, matching the wheel opening in the inner half. Apply thick CA glue to the wheel pant seams from the inside, going in through the wheel cut-outs. This seals and strengthens the pant seams.

c. In order to properly support the wheel pants and keep them from twisting in flight, a hole must be drilled through the outer pant half for the axle. If you have access to a drill press, simply lay the pant flat and drill a 3/32" dia. hole through the outer pant half, using the hole in the inner pant half as a guide. Once the hole is drilled, mount the pants and wheels back onto the landing gear. The excess axle wire, protruding from the outer pant half, is now trimmed with your Dremel Tool and a cut-off wheel, leaving about 1/32" or so exposed through the outer pant half. With the pants in place, test the fit and movement of the wheels. Make any necessary adjustments to create free movement and a good alignment.

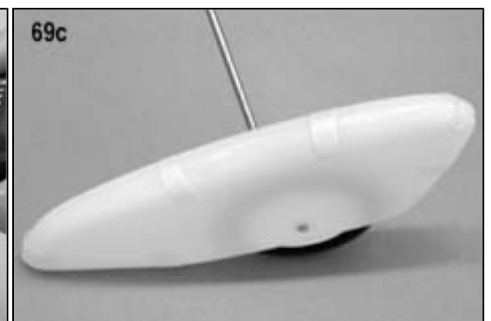

70. The wheel pants are now sanded for primer and painting. Before sanding, use a single edge razor blade to lightly scrape the pant seams. This quickly and uniformly smooths the joint seams. Use 220 sandpaper to sand the wheel pants smooth, including the joint seams. The wheel pants are now complete.

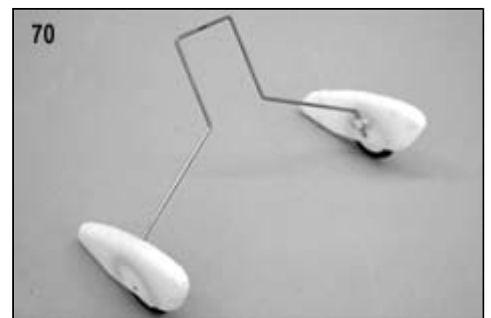

71. The 3/32" wire landing gear is now installed. The top part of the landing gear is inserted into the slots on each fuselage side, between the plywood landing gear supports. Test-fit the landing gear in place now. It should be a press-fit, with the wire snugly in place between the landing gear supports.

If needed, adjust the landing gear with pliers to get this kind of fit. Remove the landing gear and use 220 sandpaper to lightly sand the wire's vertical arms that fit between the supports in the fuselage. Use 5-minute epoxy to glue the landing gear in place, aligning it carefully. Wipe off any excess glue and allow the epoxy to cure.

72. Use 5-minute epoxy to glue the plywood landing gear brace in place to the bottom of the fuselage and the bottom fuselage sheeting at its back edge. Carefully remove any excess glue and allow to dry. Once the glue has set, the bottom access hatch can be reinstalled and the area can be lightly sanded, if needed.

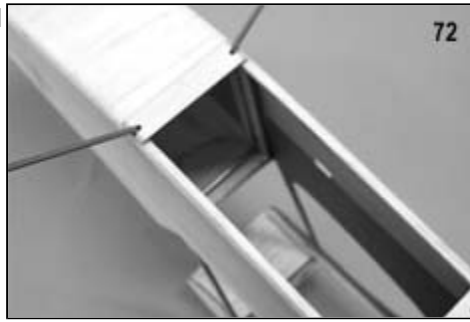

This completes the basic construction of your R/C Rascal. Inspect the airplane closely for any nicks, dings or holes that may need patching. For filler, we use and highly recommend a product called #202 Balsa Tint "Model Magic", by Dave Patrick Products for almost all of our cosmetic filler requirements. "Model Magic" weighs virtually nothing, sands easily and it's wood color blends well on balsa structures.

## COVERING AND FINISHING

In this section, you will be covering the entire model. However, do not cover the fuse/wing fairing at the top front of the cabin - this will be covered after the windshield is installed.

Everyone has their own preferred methods of covering model airplanes. We are no different and used the methods that have worked well for us for many years. Like religion and politics, the art of covering model airplanes is wide open to constant, ongoing debate. We won't get into that kind of discussion and prefer to just outline what we did. You choose the covering methods that work best for you. To assist you in creating your own unique color and trim scheme for your R/C Rascal, use the 2-view line drawing printed in this manual. Make a few photocopies, enlarging them if need be, grab some colored pencils and come up with your own custom trim scheme and color combinations to personalize your model!

The R/C Rascal lends itself to all kinds of covering possibilities. The open framework of the fuselage and wings looks really nice when covered with transparent covering films. As you can see from the models presented in this manual and on the box art, we used this look to good advantage on our own airplanes. Realistically, the R/C Rascal could be covered in a variety of materials, including the time honored silk and dope method, Litespan, UltraCote, MonoKote, etc. The only thing to keep in mind when choosing a covering material is the weight of such coverings and their potential effect on the overall weight of the model itself.

Also keep in mind the field conditions of where you will fly this airplane. If the field is rough, you may need a tough, repairable covering.

If you want to try the paneling method of covering that we used on the airplanes shown in this manual and on the box art, the technique is fairly straight forward but does require patience and some skill. The open areas are covered first with an oversize piece of the transparent color of your choice. Adhere the edges firmly in place and then shrink the material completely before trimming. With the covering completely shrunk, trim the excess material all the way around the opening, leaving about 1/4" adhered to the wood.



The plans provide you with the open area outline drawings for the fuselage, wings, etc. Use these to make a pattern to accurately cut out the required openings for the opaque part of the color scheme. We used some scrap pieces of 1/8" lite-ply for our cutting patterns.

To keep the pattern from shifting, spray just a little 3-M Super Spray aerosol adhesive onto the pattern and lay it onto the film in the approximate location it needs to be. Use a sharp #11 blade and your hobby knife to cut around the pattern, creating the opening. Carefully position the covering film in place over the already covered open area, lining up all edges. Use a cloth covered iron to first carefully adhere the covering to the edges of the transparent material and then to adhere the covering to the rest of the piece being covered.



You can also use lite-ply to make the patterns for the vertical and horizontal tail group. Using such patterns ensures the trim scheme is uniform from side to side.

After covering the glow engine version, we gave the firewall and the engine compartment a coat of epoxy resin. We brushed this resin a little over the trimmed edges of the covering, sealing them. We then gave the engine compartment a coat of white paint. We also gave the fuel tank compartment a light coat of epoxy resin. This treatment fuel-proofs the compartment and is highly recommended.

After covering, use a sharp #11 blade and your hobby knife to open the control horn locations on the bottom of the right elevator and at the bottom of the rudder, on the left side. You also need to open the exit holes for the pushrod cable exits on both sides of the fuselage. Also open the screw head holes on the bottom of the access hatch. Finally, use your knife to open up each hinge slot in the rudder and fin and the elevators and stabilizer. You will be instructed to install the control horns shortly.

## Throttle Tube Installation - Glow Engine Version

From your kit contents locate the remaining 18" length of plastic pushrod tubing. Use sandpaper to lightly scuff the outer surface of the tube. From the front face of the firewall, insert the tubing through the predrilled 1/16" dia. hole, through the tank compartment and under the F-3 former. Continue inserting the tube through the cabin, along the left fuselage side and into the previously drilled 1/16" hole in F-5. This places the throttle tube in position to be trimmed to length and glued in place. In the servo compartment, trim the tubing to a length of about 3/4" from the rear face of F-5. In the engine compartment, trim the tubing to a length of about 1-1/2" from the front face of the firewall (later, when connecting the throttle cable to the engine and servo, the tubing will likely be trimmed a bit more).

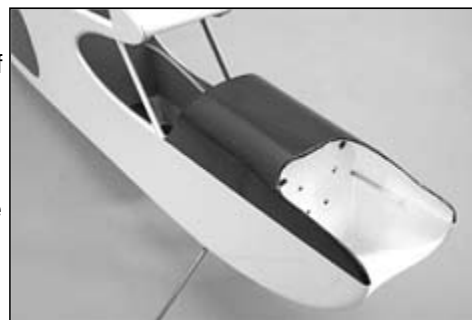

To secure the tubing permanently in place, use thick CA glue to glue it to the backside of the firewall, against the bottom of F-3 and to the rear face of F-5.

## Fuel Tank Installation - Glow Engine Version

With the throttle tubing in place and the engine compartment fuelproofed, the fuel tank can now be installed. Back in Step 18 of the FUSELAGE construction section, you assembled the fuel tank and cut two pieces of 3/16" square balsa to support it. You have already installed the front 3/16" sq. tank support.

An easy way to install the tank with the fuel tubing connections already in place is to cut a single 13" length of small diameter fuel tubing. Use a razor blade to trim both ends of the tubing at sharp angles. Remove the access hatch from the fuselage bottom. From the front face of the firewall, insert the ends of the fuel tubing into each of the two holes already drilled. Use long tweezers or a hemostat to reach into the fuselage, through the access hatch opening, to grab the fuel tubing ends, pulling them through the firewall and out the access hatch opening. Re-cut the ends of the tubing square and slip them onto the fuel tank tubes.

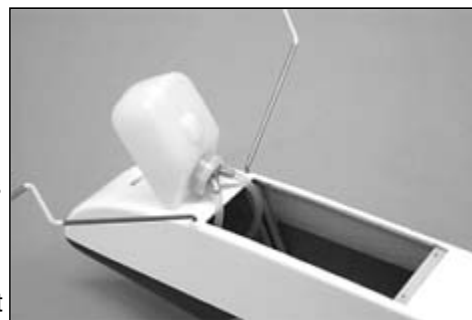

While pulling lightly on the tubing from the firewall side, install the tank into the fuselage and up onto the forward 3/16" sq. tank support. With the tank now in position, install the remaining rear 3/16" sq. tank support in place. Apply a small amount of glue to secure the support in place to the fuselage sides. Later, if necessary, the tank can be easily removed by just breaking loose the rear support. Last, we placed a couple of thin pieces of foam on each side of the tank to hold it firmly in place.



## Detail Painting

Now is the time to paint the two main wheel pants, tailwheel pant and two control horns. For our models, we chose to use base and trim colors, matching our covering scheme. Prepare the plastic wheel pants for painting by sanding smooth and applying a primer that is compatible with the paint you intend to use. We gave the tailwheel pant assembly a single coat of surfacing resin, followed by a coat of primer. The control horns only need a coat primer to get them ready to paint.

Wet-sand these parts with #600 sandpaper before painting. If you built the electric version of the R/C Rascal, you don't have to worry about fuel and can use just about any paint you like. For those of you who built the glow engine version, the paint you use must be fuel proof.

On our models, we used K&B Superpoxy for the base white color, thinned about 33% and applied with a small airbrush. If you don't own an airbrush, you can either use fuel proof paints sold in aerosol spray cans or the time-honored paintbrush. For the control horns, tape-off about 3/32" of the bottom of each horn with masking tape. The tape makes a good handle for painting purposes and leaves the wood unpainted for gluing in place later.

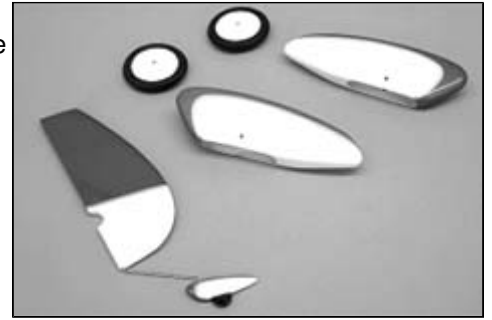

## Control Horns And Hinging Tail Surfaces

The rudder and elevator control horns are now installed. Use a little 5-minute epoxy on each side of the horn, where it will be buried into the surface and press in place. Wipe off any excess glue with alcohol and allow the epoxy to cure. The elevators and rudder can now be hinged to the stabilizer and vertical fin. Start with the elevators. Assemble the elevator to the stabilizer with the required six Easy Hinges in place. Carefully apply 3 or 4 drops of thin CA glue across the top of each hinge. Turn the fuselage over and again apply 3 or 4 drops of thin CA glue to each hinge location. Do not flex the elevators and hinges for at least 15 minutes. The rudder is hinged in place next, using the required three Easy Hinges. The technique is the same. Apply 3 or 4 drops of thin CA glue to each hinge location on one side and then do the same thing to the opposite sides of the hinges. Allow at least 15 minutes before flexing the rudder. Any excess glue that may have gotten onto the covering can be removed with CA debonder.



## Landing Gear Fairings

As you can see in the photographs of our R/C Rascal models, the landing gear legs have been covered with color matching fairings. These are easy to make and add a nice look to the finished model. Here's how we did it.

Use the Landing Gear Fairing Pattern to cut two identical fairings from 2-3/4"x4-1/4" white cardstock included in your kit. After cutting out the fairings, fold them firmly at their leading edge with a heavy crease. Remove the wheel pants and wheels from the fuselage and lightly sand the metal landing gear legs to remove any oils, etc. Apply a thin coat of 5-minute epoxy to the inside surface of the card fairing and slip it in place over the wire landing gear leg. Use a small paper clamp and a couple of pieces of scrap balsa sticks to hold the trailing edges of the fairing together and straight. Align the fairing accurately front to rear, on the landing gear leg. Wipe off any excess glue and allow the epoxy to cure.

### MAIN GEAR FAIRING PATTERN

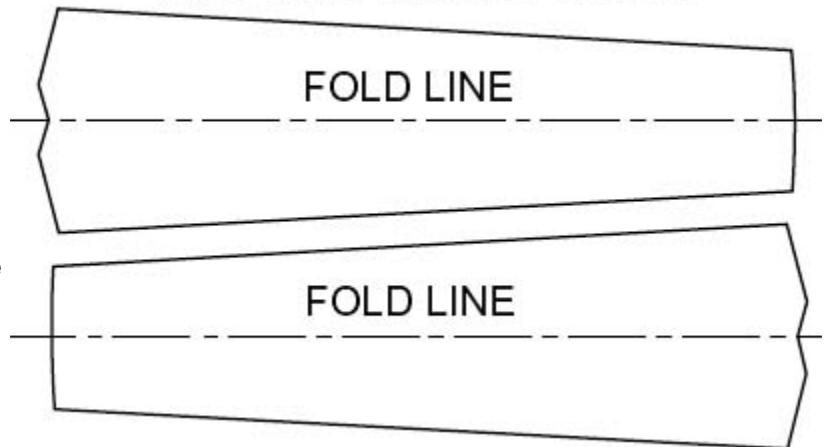

After the epoxy cures, remove the clamps. Lightly sand the trailing edge of the fairing to remove any glue and to create a hard edge. The fairings can then be covered, using the same covering material used to cover the model. The small Top Flite Models Trim Seal Tool with the small, flat shoe is perfect for this job. If you take your time the results look great and the fairings hold up perfectly in actual use.

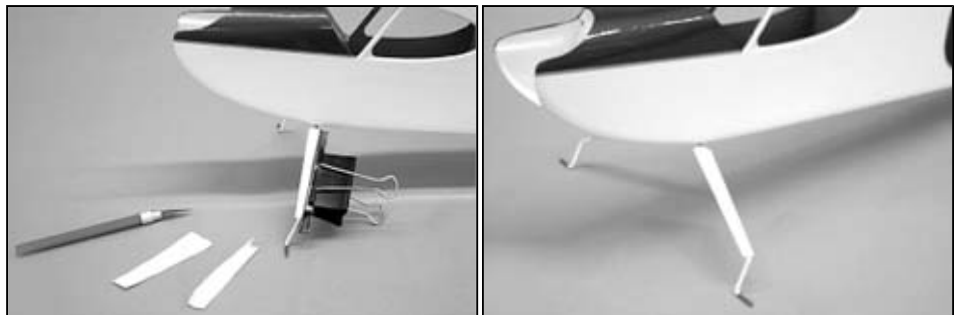

## Cockpit Braces

As shown on the plans and in the photographs of our models, the forward cockpit, at the windshield, has two aluminum tube braces forming a V at the top of the instrument panel. The top ends of these tubes fit into the corners at the inside top of the cockpit wing fairing, against F-4.

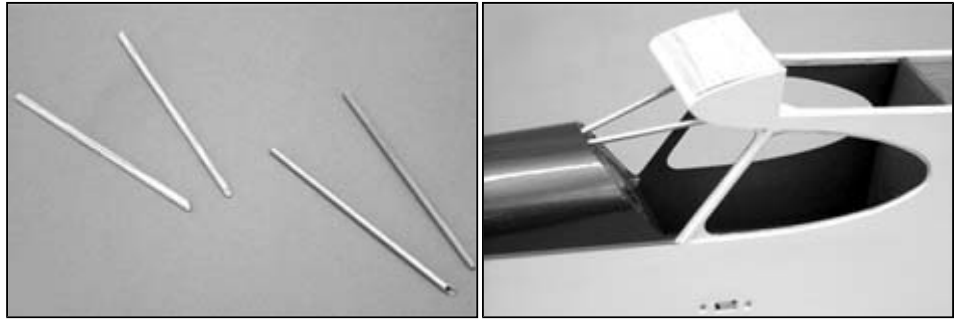

These braces offer support to the top of the cockpit area and also add a believable look to the pilot's office. From your kit contents locate the two 3/32" dia. x3" aluminum tubes.

These have been cut oversize and must be trimmed to length. Confirm the exact cutting length for these tubes by first using scrap pieces of 1/16" balsa sticks held in place. Once you have the exact size, use a single edge razor blade to cut the tubes to length. Sand the ends a little, angling them to a point. Apply a little 5-minute epoxy to each end and press them firmly in place.

## Window Installation

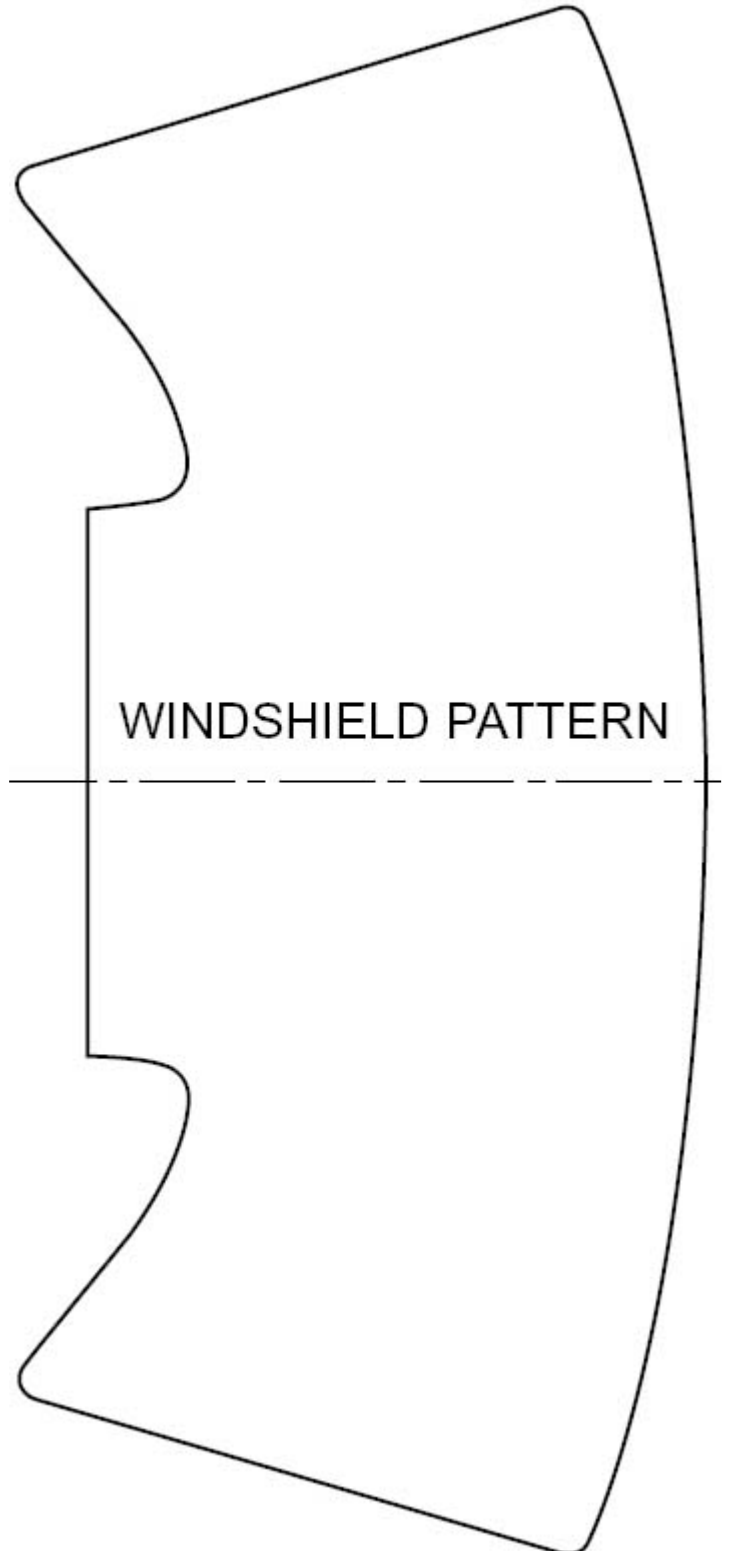
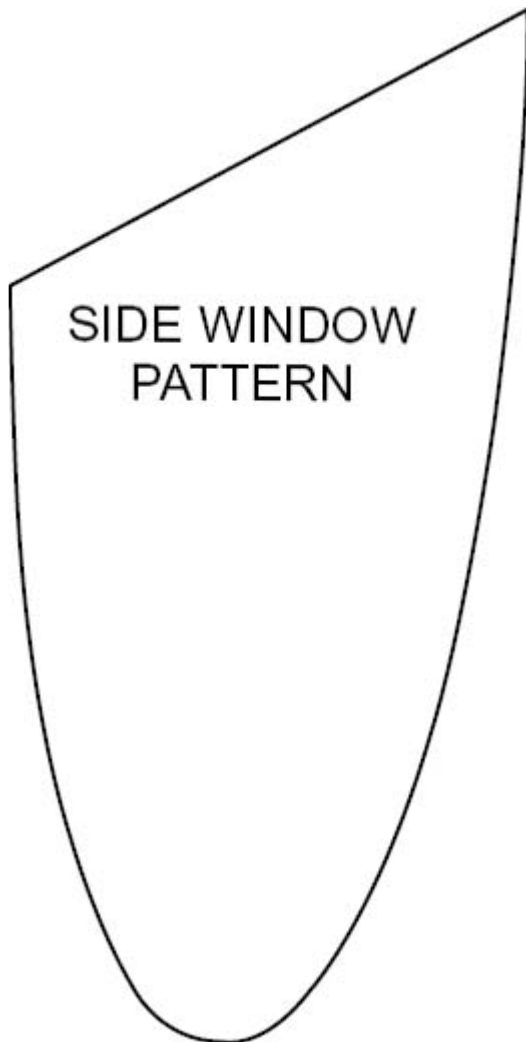



From your kit contents, locate the 3 x 7 clear plastic sheet that will be used for the windows. This material is .008 thick. Do not attempt to dye this plastic and avoid heating it. Using the patterns provided on page of this manual and a pair of good scissors, cut out two side windows and one windshield. We suggest adhering the patterns directly to the clear plastic with a light spray of 3-M Super 77 spray cement. After cutting out the windows, remove any residual cement with mineral spirits.

We suggest starting with the windshield. We used SIG Kwik-Set 5-Minute Epoxy to glue our windows in place. Do not use CA glue for this job. We glued the windshield in place using three separate steps. Start with the top of the windshield, gluing it in place to the top of the fuselage wing fairing. Center the windshield carefully, holding it in place using masking tape - allow the glue to cure.

Next, apply a small amount of glue to the forward edge of the fuselage upright cabin support brace (choose either the right or left fuselage side). Wipe off any excess epoxy with a rag and alcohol. Pull the windshield side around to the upright brace, pressing it in place. Use clothespins to hold the windshield firmly to the brace and allow the glue to cure. Repeat this process on the opposite side of the fuselage. After the glue has set, remove the tape and clothespins. You can clean up epoxy smears with a rag and alcohol.

The side windows are now installed. Use a pointed piece of dowel to apply 5-minute epoxy to the fuselage window frame edges. Wipe off any excess glue with alcohol and a rag. Press the window in place into the frame. Again use a little alcohol to clean off any excess or oozing glue and allow the glue to cure. Repeat this step with the opposite side window.

Finally, to seal the windshield to the top front of the fuselage, we used either trim tape or a pre-cut strip of the covering material. If you use the covering material, you will have to use a heat-sealing tool to adhere it in place. The top fuselage/wing fairing is now covered. Be sure to use low heat and avoid prolonged contact with the windshield itself.

## Decal Application

With the model now covered, you can add the decals. These are not die-cut and need to be cut from the sheet using a sharp #11 blade and your hobby knife. In order to avoid harming the decal and to provide you with the ability to position each decal exactly, use a little SIG Pure Magic Model Airplane Cleaner, Fantastic Windex, or 409<sup>®</sup> type cleaners. Spray a little cleaner on the model, in the decal's location. Spray a bit more on the sticky side of the decal. Now lightly position the decal in place on the model. The cleaner allows you to slide it exactly into position - don't press down on the decal. Once in position, use a paper towel to lightly dab the excess liquid away. Use a squeegee to set the decal in place (the SIG 4 Epoxy Spreader - SIGSH678 - is perfect for this job). Mop up any excess cleaner with a dry cloth and allow the decals to set overnight. They will now be solidly adhered to the model.

## Radio Installation And Control Movements

We used the Hitec Micro 555 receiver in both the electric and glow versions of our R/C Rascals. We highly recommend this receiver for its light weight, small size and outstanding operating characteristics. In electric applications, we found this receiver to be very selective. We did not require any additional RF capacitors on the motor, other than those installed by Maxx Products in their Speed 400 motor system.

### ELECTRIC:

If you built the electric version of the R/C Rascal, you'll need a good speed controller. What you should look for in these devices is BEC circuitry (Battery Elimination Circuit), the ability to safely handle 7 or 8 cell battery packs, ease of set-up and finally, it should be light weight and small. The speed controller we've used with our electric R/C Rascals is the JETI Models #JES 180.

We obtained this product from Hobby Lobby International (see Manufacturer's Index) and it has proven to be outstanding in actual use. It has all of the above features plus an audio set-up signal, a wired-in on/off switch and very good installation instructions.

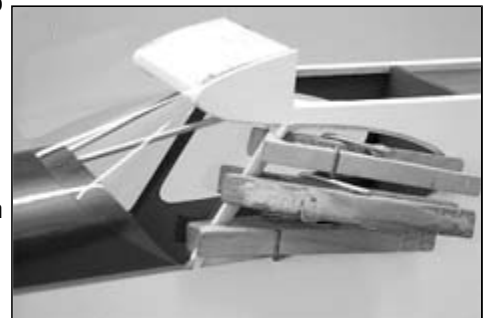
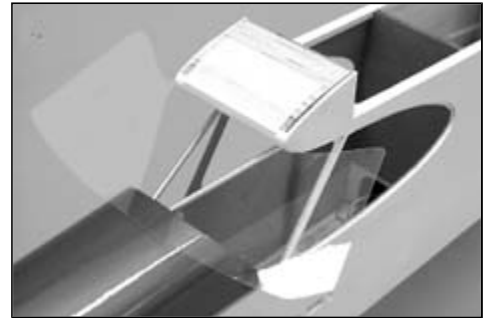

Throughout our testing of the electric version of this model, we used both 7 and 8 cell battery packs, using Sanyo KR-600AE cells (1.2 volt, 600mAH). These battery packs have provided outstanding power and duration and we can highly recommend them. We honestly feel that if you're trying to save money, don't do it on batteries! We also used and highly recommend the AstroFlight Model 115D AC/DC Digital Peak Battery Charger. This charger is user friendly, very affordable and does the job every time.

Before installing the rudder and elevator servos, remove their output arm screws. Install the servos in the servo tray, routing the cables through the cut-out in former F-5.

The motor and gearbox are now prepared for installation. Solder the wires onto the motor's terminals (you'll need about 5" of wire length) and solder the connectors onto the wire ends. The Maxx gearbox is now attached to the front of the motor, using the two screws provided. As discussed earlier, the Maxx gearbox comes with three primary gears; 2.1:1 (14 tooth), 2.5:1 (12 tooth) and 3:1 (10 tooth). We have done most of our test flying using the 2.1:1 and 2.5:1 gears. Install the primary gear onto the motor's shaft. Adjust the gear lash as closely as possible to the aluminum drive gear. Note that there must be at least a small fraction of play between these two gears, but very little.

Also, we have made it a habit to use non-permanent threadlock compound whenever installing the above parts. This helps to keep everything together.

Install the Maxx Clam Shell motor mount onto the bottom of the plywood mount in the nose of the airplane, leaving the bolts a little loose. Slide the connectors through the mount and the bottom half of the firewall hole, into the fuselage. Slide the motor body into the Clam Shell mount, until it bottoms out at the back of the ply mount. Center the gearbox shaft to the fuselage and tighten the clam shell motor mount bolts, locking the motor in place.

From the bottom access hatch, connect the speed controller to the motor side of its connectors. Install the speed controller's On/Off switch into the left side of the fuselage, using the slot and screw holes made earlier. The speed controller is now placed into the tank compartment, behind the firewall - do not wrap it in anything.

Connect the rudder and elevator servos to the appropriate receiver receptacles. Connect the speed controller's receiver connector to the appropriate throttle channel receptacle. Without a propeller on the motor, connect the speed controller to a freshly charged battery pack. Turn the transmitter on first, followed by the switch mounted in the airplane. Using the transmitter, try your controls. Make sure the transmitter trims are at neutral. If needed, lift the servo output arms off the servos and reposition them squarely in place. Next, check to see if the servos are moving in the correct directions to provide left and right and up and down. Reverse the travel direction of the servos if needed. Next, try the throttle. If throttle direction is wrong, nothing will happen. In this case, turn the system off, reverse the throttle direction on your transmitter and turn the system back on. Again try throttle - it should work fine if you followed the instructions that came with the speed controller. Disconnect the batteries from the speed controller.

After checking out the system, the receiver can be placed in the airplane. As mentioned earlier, we simply placed the receiver beneath the servos, between F-5 and F-6. Assuming you are using a speed controller with BEC, the flight batteries are attached to the bottom access hatch using the 4" length of Velcro tape included in your kit.

We ran the receiver antenna out through the top of the right fuselage side and then back to the rear of the fuselage, to the tailpost. A simple bent pin hook was made to hold the antenna in place, using a small rubber band for tension.

#### **GLOW:**

Remove the output arm screws from the servos and install the three servos in place onto the servo tray. Route their connector cables out through the opening at the bottom of F-5. We used a Hitec 270mAH battery pack to power our system. This little pack provides an honest hour of flight time, which is more than adequate. We placed the battery pack directly beneath the fuel tank, wrapped in light foam.

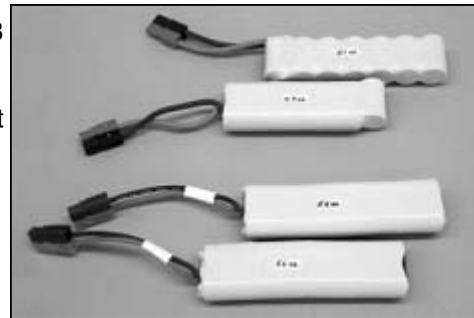

Our Hitec 555 receiver was placed in a foam rectangle, cut to fit on the cabin floor. The antenna is routed out of the fuselage in the same manner as the electric version. The switch is mounted in the same location as the electric version.

Make the servo connections to the receiver and connect the battery pack to the switch. Turn on your transmitter and airborne switch to test the movement of the servos. Check the direction of travel of each servo. Reverse the direction of travel of any servo that needs it. Make sure the transmitter trims are in neutral. Reposition the rudder and elevator servo output arms to square them in position.

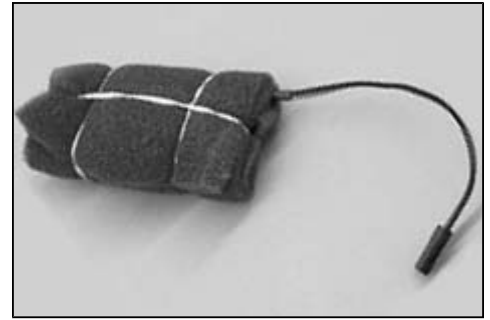

## Control Linkages

With the radio system now installed and working, the control linkages can now be made. Note that the methods for making the control linkages for either version of this model are the same. You will need the following tools and supplies;

From your kit:

- 2 paper clips
- 4 1/16" OD x 1/4" brass tube couplers
- 2 .031 x 18" braided cable pushrods

Tools & supplies:

- Pair of Needle Nose Pliers
- Pair of Diagonal Cutters
- A good pencil type Soldering Iron (such as the K&S 30 watt model)
- Solder & Flux (we highly recommend and use the #11000 Harris Stay-Brite<sup>®</sup> Silver Solder kit)
- a fine-line marker pen



Start by straightening out both paper clips into two single lengths of soft wire. Use needle nose pliers to make a simple Z-bend at one end of one of the wires. Use the diagonal cutters to cut off the Z-bend end of the wire about 1/2" behind the last bend. Repeat this procedure at the opposite end of the paper clip wire. These two Z-bend connectors will be used at the control surface end of the pushrods.

As shown, the wire connectors that attach to the servos are the same as the flying surface connectors except they have a simple V-bend into them behind the Z-bend. This V-bend allows surface adjustments to be made without having to use the radio. Open the V-bend a little to adjust the surface in one direction or close the bend a little to adjust the surface in the opposite direction. Use the second piece of wire to make two of these connectors.

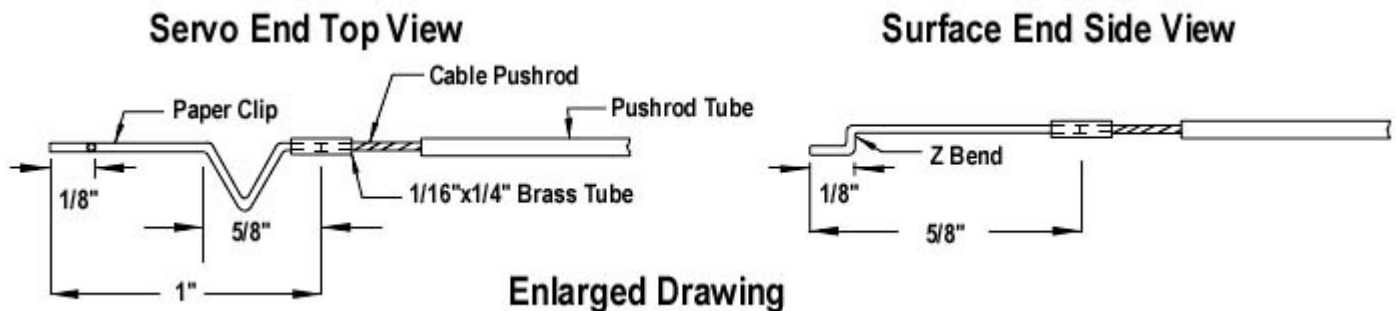

The V-bend connectors are now soldered to one end of each of the two cable pushrods, using two of the brass tube couplers for the connection. Slide the tube onto the cable, line-up the straight end of the connector with the cable and slide the brass tube half way onto the connector. Apply a small amount of Stay-Brite<sup>®</sup> flux to the cable and connector and use a tiny amount of solder to sweat the cable/tube/connector joints. The two cables can now be inserted into their tubes in the servo compartment. Fit the Z-bend of each connector onto the servo output arms and press the output arms squarely back in place onto each servo.

All that remains is the connection of each pushrod end to their respective rudder and elevator horns. Start with the elevators. Use a small piece of masking tape at each elevator tip to hold the elevators in neutral to the stabilizer. Turn on the radio system to accurately center the servos and lay the fuselage on its side on your workbench. Slip one of the Z-bend connectors into the outer most (bottom) elevator horn hole. Hold the pushrod cable in line with the straight end of the connector and use a fine line marker pen to make a mark on the cable where it just meets the end of the connector. Use the diagonal cutters to cut the cable end at the mark just made.

Use a small piece of aluminum foil over at the back of the fuselage, just behind the pushrod exit, to protect the fuselage from a possible stray drop of solder. Slip a brass tube connector onto the cable. As before, line-up the end of the connector wire with the end of the cable and slide the brass tube halfway onto the connector. Place a small amount of flux on the cable/tube/connector joint and use a small amount of solder to sweat the joint together. Remove the foil and tape from the elevators and test the elevator movement with your radio. Turn the fuselage over and repeat this process with the rudder connection.

If you have built the glow version of this model, you must now make the throttle pushrod connections. As shown on the plans, the cable pushrod slips into its housing tube and extends from the engines throttle arm back through the fuselage to the throttle servo. Use a small scrap piece of 1/8" balsa to wedge the servo end of the pushrod tube out toward the servos output arm. Use your radio system to run the throttle servo to one end of its total travel and reposition the output arm accordingly. Make absolutely sure that the servo is traveling in the right direction to provide high and low throttle movements to the engine! Make two more wire Z-bend connectors from the remaining paper clip wire. Using the method described earlier, solder one of these connectors onto one end of the 12" length of supplied throttle cable with a brass tube joiner. Attach the connector to the engine s throttle arm (on our Norvel BigMig .061 engines, we used the bottom hole). Insert the bare end of the throttle cable into the throttle tube at the firewall and temporarily mount the engine in place to the firewall with just two bolts.

Line the throttle cable up with the remaining wire connector and mark where it is to be cut with your marker pen. Remove the engine and cable. Cut the cable to length at the mark just made. Reinstall the cable and engine. Back in the servo compartment, slip a brass joiner tube over the cable end, line-up the wire connector and slide the tube over the wire end, supporting both the cable and the wire. Apply a little flux to this joint and use just a little solder to sweat these joints together. Test the throttle pushrod system with your radio.

With the servo connections now made, the control movements can now be set to the following suggested throws. If you are using a modern radio, with servo movement control capability, these movements can be simply inputted through the transmitter. Last, be sure to secure the servo output arms in place with their locking screws.

<b>Recommended Initial Control Movements</b>	
RUDDER	3/8 Right, 3/8 Left
ELEVATORS	1/4 Up, 1/4 Down

## Balance

As shown on the plans, the Center of Balance (or Center of Gravity) for both versions of the R/C Rascal is located directly on the wing spar. Before attempting to balance the model, remember the following:

WHEN BALANCING THE GLOW ENGINE VERSION OF THIS MODEL, THE FUEL TANK MUST BE EMPTY.  
WHEN BALANCING THE ELECTRIC VERSION, THE AIRBORNE BATTERY PACK MUST BE INSTALLED.

The most efficient method for establishing the correct CG location is to shift the position of the batteries as needed, until the airplane balances at the spar. If for some reason this does not work and you still find that you need more weight either up front or at the rear, then you must consider the use of clay, lead or brass weights. DO NOT attempt to fly this model with a CG location behind the spar. A CG location that is a little ahead of the position shown will not necessarily be a problem but may result in having to add a small amount of up elevator trim in flight to compensate for a nose heavy condition. To maximize the flight potential of your R/C Rascal, we strongly suggest using weights to properly balance the model. The amount of weight needed to achieve balance will likely be very small.

Weight in the nose area is easy to conceal either just behind the firewall or secured to the firewall, on it s front face. For tail weight, we suggest using commercially available stick-on lead weights, such as those from Prather Products. Later, after test flying and fine tuning the airplane, the weight can be placed inside the rear of the fuselage by simply cutting or drilling a small hole in the bottom, just behind Former F-7. Insert the weight into the hole, pushing it as far back as possible. Clean up the area with alcohol and recover the hole with iron-on covering. This simple fix is all but invisible.

## Propellers

We did a lot of propeller experimenting with both versions of this model. While our tests were certainly not scientific, they did serve to help us make our decisions. The following are our findings and suggestions. You should experiment with your own model to determine the ideal combination of power and propellers.

### **ELECTRIC VERSION:**

Using the Maxx Products Speed 400 motor and gearbox unit, we liked and used 8" diameter props with pitches of 4 to 6 . We tried both wood and plastic props and found a fair amount of differences in all of them. Eventually we discovered the new APC Electric props and in particular, their 8"x6" prop, P/N LP08060E. This prop has turned out to be outstanding in all around performance with the R/C Rascal.

## **GLOW VERSION:**

We used both the Norvel .061 BigMig R/C and AP .061 R/C engines for all of our flight-testing. These engines happily turned 6"x2-1/2", 6"x3", 6"x4" and 7"x3" propellers. However, because the idle on the Norvel is fairly high, we found that using props with too much pitch made landing speeds a little high. We solved this by using a Zingali (J&Z) 6 x 2-1/2 propeller. This small diameter, low-pitch propeller worked well for us at both ends of the throttle. Our little AP .061 has a lower idle and we therefore used a 6"x3" prop.

Finally, we urge you to always balance your propellers for optimum performance and safety. Never fly a prop that is nicked or cracked and always make sure it is securely in place to the motor.

## **FLYING**

---

If you have followed the instructions in this manual, test flying your R/C Rascal should be a pleasure! Choose a calm day with little or no wind for initial test flights. This is important in getting the model properly trimmed. We also suggest that for the first few familiarization flights, you or a flying buddy hand-launch the model. When hand launching, the airplane should be launched straight and level directly into the wind, with the nose aimed at a point on the ground, about 75 in front of you. NEVER launch the model with the nose pointed up or the wings tipped to one side. The launch should be firm enough to achieve flying speed but not overly hard. Later when you re more familiar with the airplane and how it flies, you can perform R.O.G. (Rise Off Ground) takeoffs.

The electric version of the R/C Rascal should climb briskly at full power and you should have no problem in getting to a comfortable trimming altitude quickly. At altitude, throttle back to about 1/2 throttle and get familiar with the model at this cruising speed. Take care of any trim requirements that may be needed and settle back to enjoy the flight! Now is the time to find out how the airplane reacts to control inputs. Properly set-up, with the CG in the right location, the airplane should be very comfortable to fly at the suggested control throws. Throttle all the way back, turning off the motor and check out the glide. It should be quite flat and fairly slow - perfect for hunting lift! While still at altitude, with the motor off, test the stall characteristics of the airplane. Our R/C Rascals have demonstrated very straightforward, shallow stalls with almost instant recovery.

If you built the glow engine version, with a third channel for throttle, you ll quickly find that the little Norvel .061 makes a lot of power! We fly our Norvel powered Rascals at about 1/3 to 1/2 throttle, saving full throttle for climb outs and mild aerobatics. Our Norvel engines idle so reliably that we could also go thermal hunting with complete confidence that the engine would stay running, as long as it had fuel. The real secret to this reliability is taking the time to bench run and completely break-in the engine, using the right propeller and the correct fuel. We broke our engines in using SIG 25% nitro 1/2A fuel (SIGCF016 in quarts). After break-in we switched to SIG 15% Nitro Airplane fuel. Both Cox and Norvel engines run great on these fuels, giving them solid needle valve settings and, in the case of the R/C Norvel engines, very reliable idling characteristics.



The R/C Rascal has 3; of built-in down thrust. During our flight testing of this design, we found that we did not need any additional down thrust or any right thrust at all. However, different engines may make the model react differently. If, after flying your model, you feel that you might need more or less down thrust or some right thrust, use small washers beneath the engine bearers or behind the motor mount to make these kinds of adjustments. The R/C Rascal is capable of performing some reasonable aerobatics. It will do surprisingly axial rudder rolls, consecutive loops, very nice stall turns, good looking Cuban eights, etc. In addition, we found that the airplane flies quite well inverted, once you get used to the rudder. Our R/C Rascals have always refused to spin.

Because the model has such a great glide, landings are easy. Simply fly it right down to where you want to land it, flare a little as it nears the ground and let the airplane settle lightly into a 3-point landing - every time! We believe you ll soon be very comfortable with the R/C Rascal and that it will quickly become one of your favorite models. We sincerely hope that this has been a pleasurable project for you and that you will take at least a little time to share the hobby and all of its rewards with someone special in your life. Please fly this model safely with constant regard to other fliers, spectators and property.

**Good luck and good flying!**



#### SPECIFICATIONS:

WING SPAN:	49
WING AREA:	324 sq. in.
LENGTH:	32-1/2
POWER	ELECTRIC: MAXX SPEED 400 MOTOR AND GEAR DRIVE UNIT GLOW: .049 - .07 ENGINES
FLYING WEIGHT	GAS: 18.5 ounces* ELEC.: 23 ounces*
CONTROLS	Rudder, Elevator, and Throttle

(\*Note: These weights were obtained by building the actual kit and using the covering techniques, radio equipment and batteries specified in this manual. The finished weight of your model may be different if you use heavier or lighter equipment and/or covering and finishing techniques. The above weight of the electric version includes an 8-cell KR-600AE battery pack, weighing 5.6 ounces, with connectors.)

**WARNING! THIS IS NOT A TOY!**

Flying machines of any form, either model-size or full-size, are not toys! Because of the speeds that airplanes must achieve in order to fly, they are capable of causing serious bodily harm and property damage if they crash. IT IS YOUR RESPONSIBILITY AND YOURS ALONE to assemble this model airplane correctly according to the plans and instructions, to ground test the finished model before each flight to make sure it is completely airworthy, and to always fly your model in a safe location and in a safe manner. The first test flights should only be made by an experienced R/C flyer, familiar with high performance R/C aircraft.

The governing body for radio-control model airplanes in the United States is the ACADEMY OF MODEL AERONAUTICS, commonly called the AMA. The AMA SAFETY CODE provides guidelines for the safe operation of R/C model airplanes. While AMA membership is not necessarily mandatory, it is required by most R/C flying clubs in the U.S. and provides you with important liability insurance in case your R/C model should ever cause serious property damage or personal injury to someone else. For more information, contact:

ACADEMY OF MODEL AERONAUTICS  
5151 East Memorial Drive  
Muncie, IN 47302  
Telephone: (317) 287-1256

**Customer Service**

SIG MFG. CO. is totally committed to your success in both building and flying the RASCAL design. Should you encounter any problem building this kit, or discover any missing or damaged parts, please feel free to contact us by mail or telephone.

<b>SIG MFG. CO., INC.</b> <b>401-7 South Front Street</b> <b>Montezuma, IA 50171-0520</b>	SIG MODELER S ORDERLINE: (to order parts)	1-800-247-5008
	SIG MODELER S HOTLINE (for technical support)	1-641-623-0215
	SIG WEB SITE:	<a href="http://www.sigmfg.com">www.sigmfg.com</a>

---

© Copyright SIG Mfg. Co., Inc.

**SIG MFG. CO., INC.....Montezuma, Iowa 50171-0520**

**LIMIT OF LIABILITY:**

The craftsmanship, attention to detail and actions of the builder/flyer of this model airplane kit will ultimately determine the airworthiness, flight performance and safety of the finished model. SIG MFG. CO's obligation shall be to replace those parts of the kit proven to be defective or missing. The user shall determine the suitability of the product for his or her intended use and shall assume all risk and liability in connection therewith.