

PIPER SC

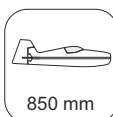

1150 mm



850 mm



380g

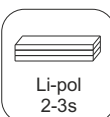

Li-pol
2-3s

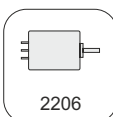

2206

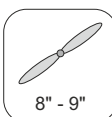

8" - 9"

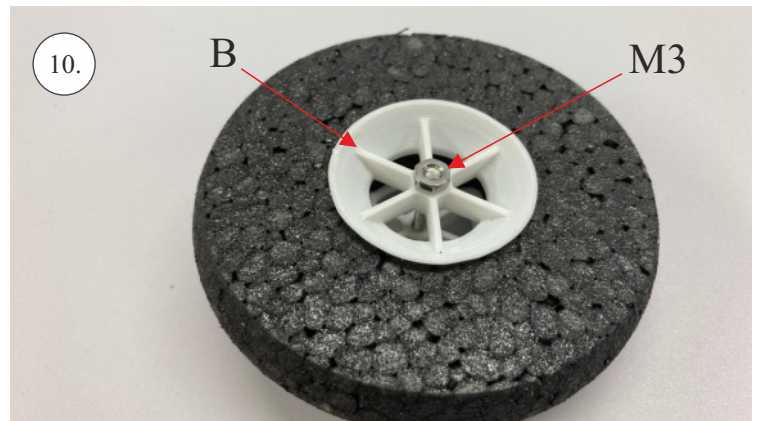
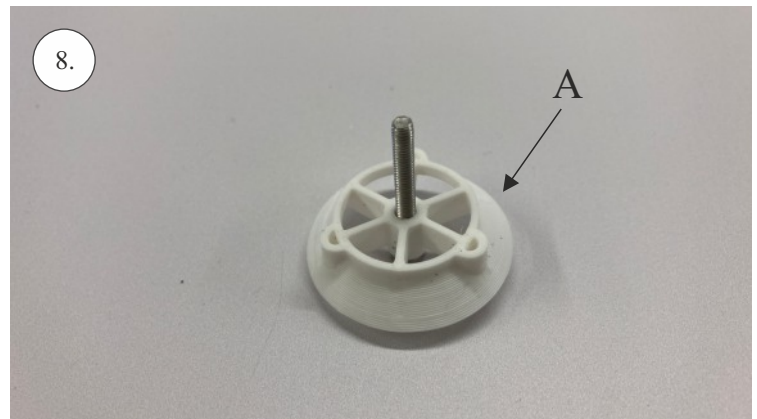
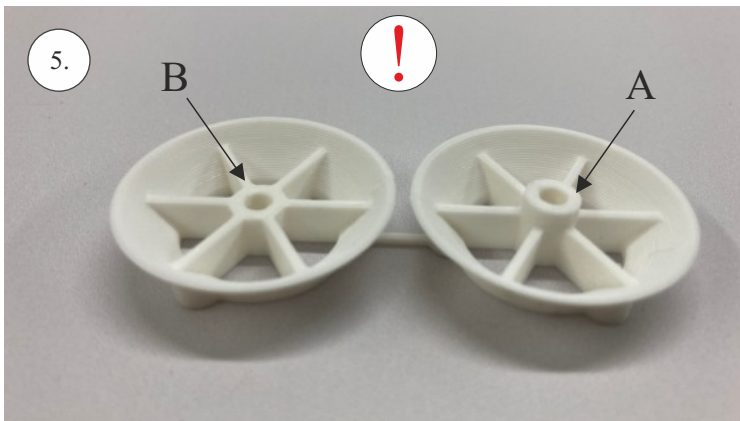
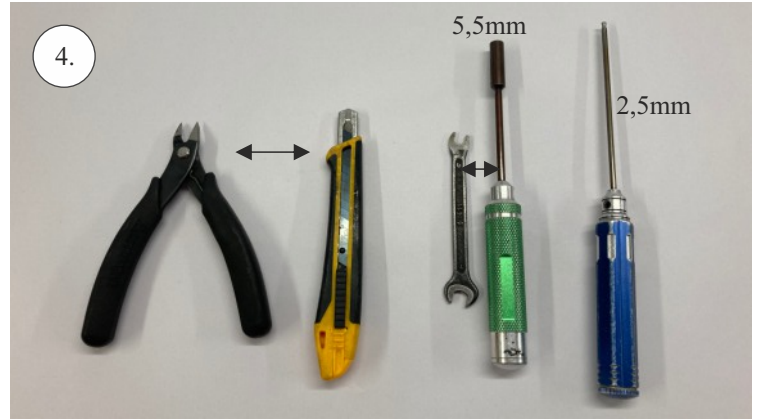
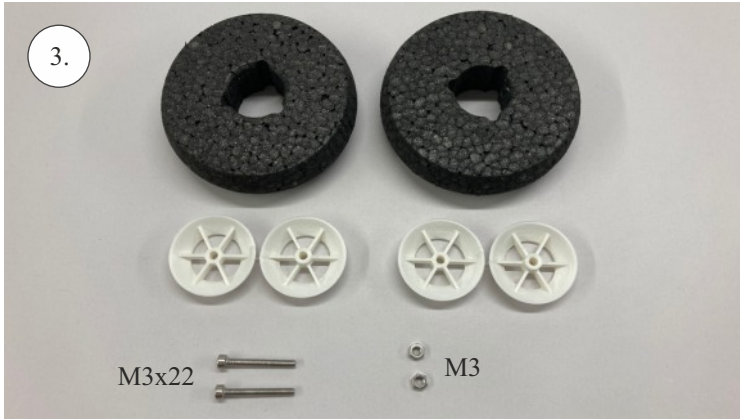

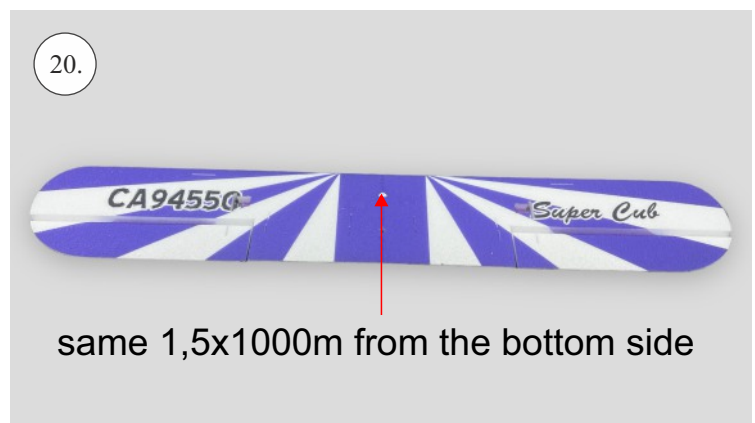
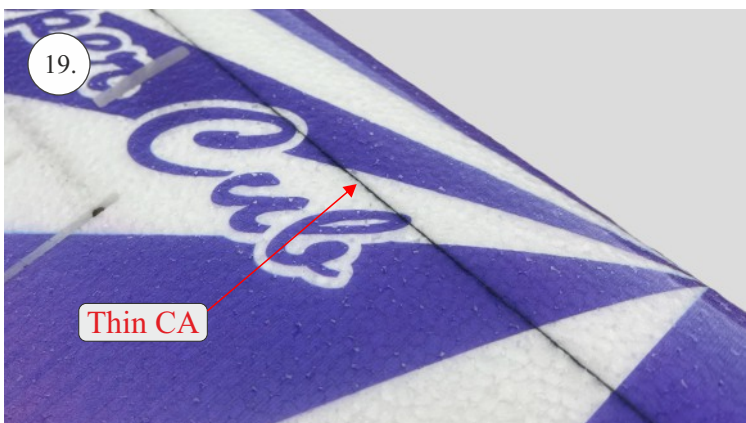
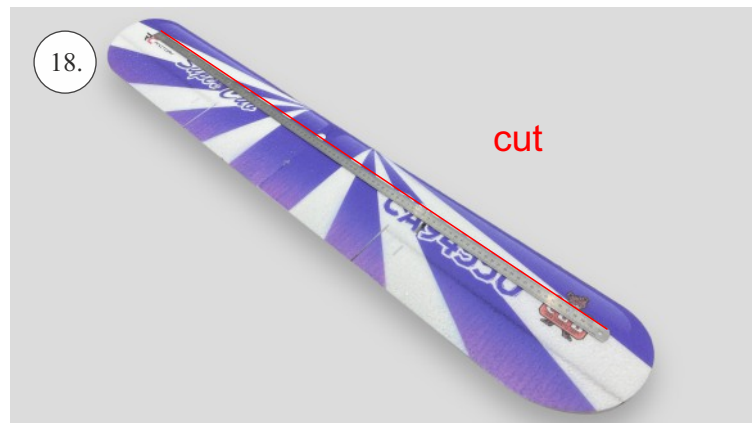
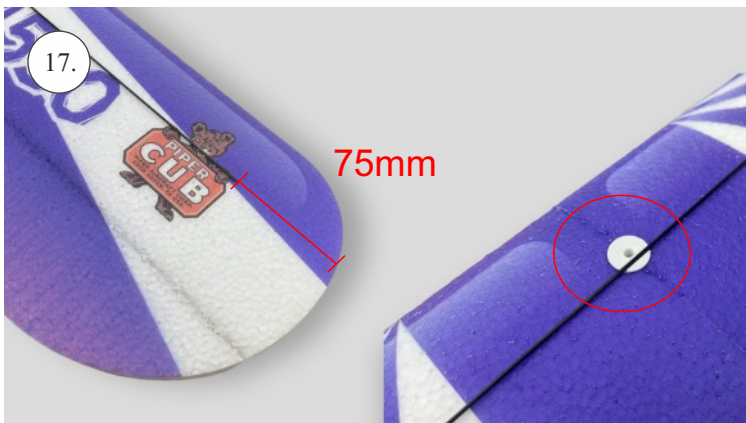
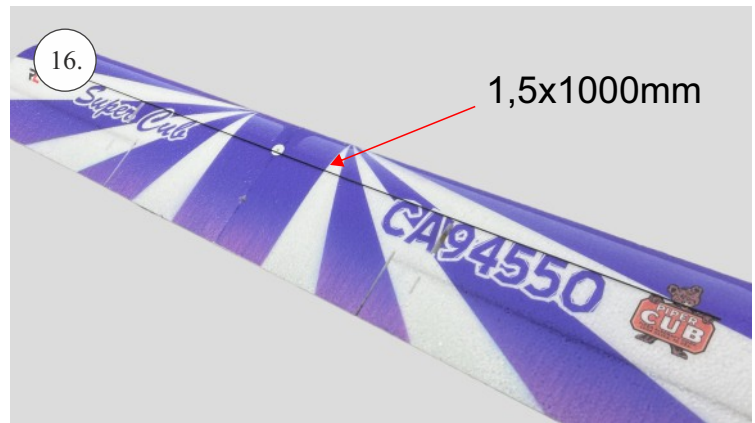
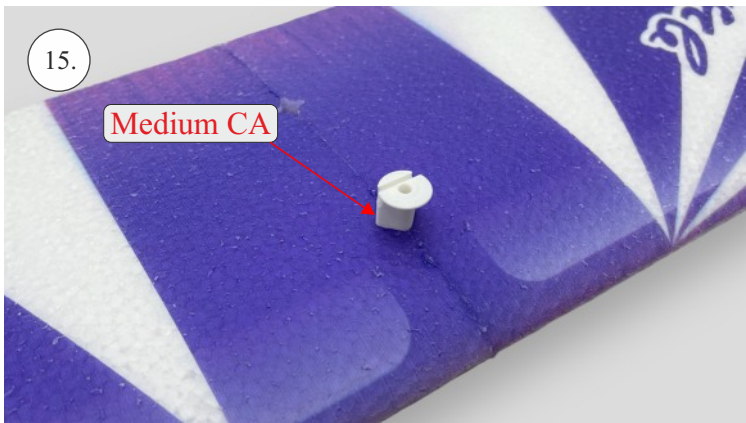
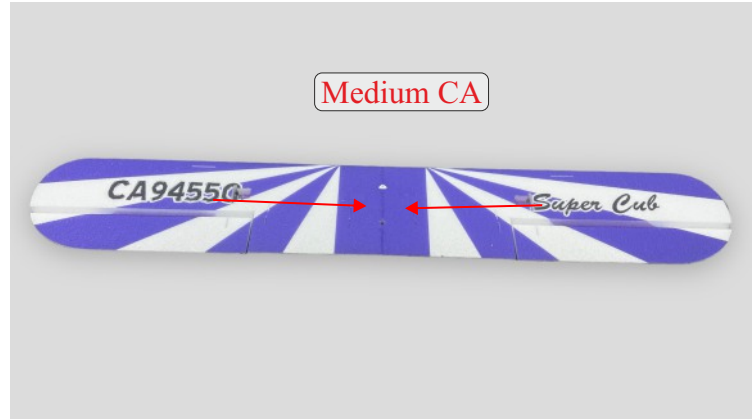
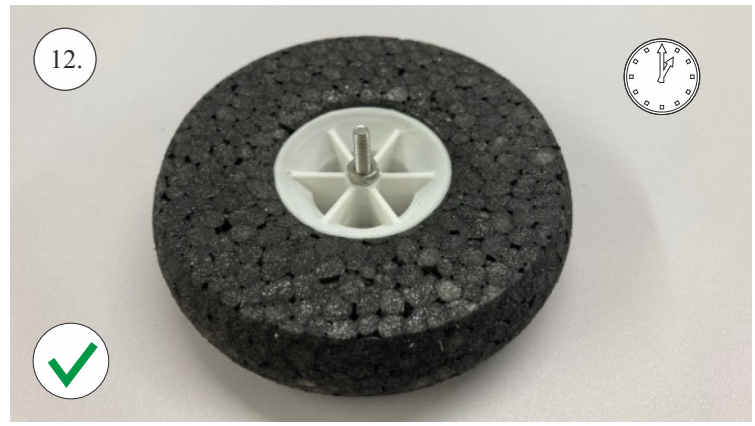
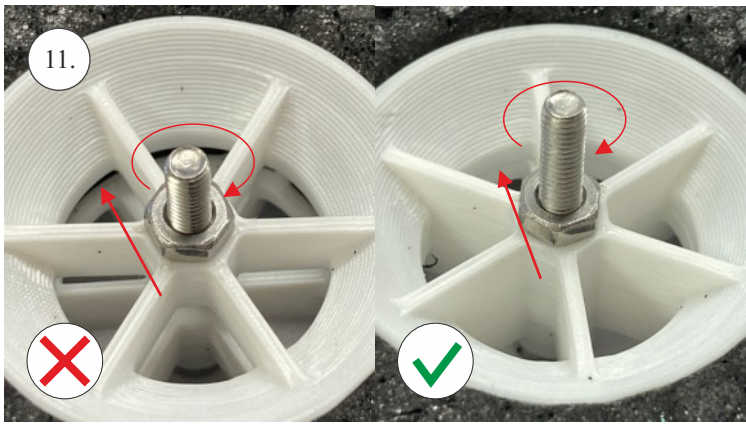

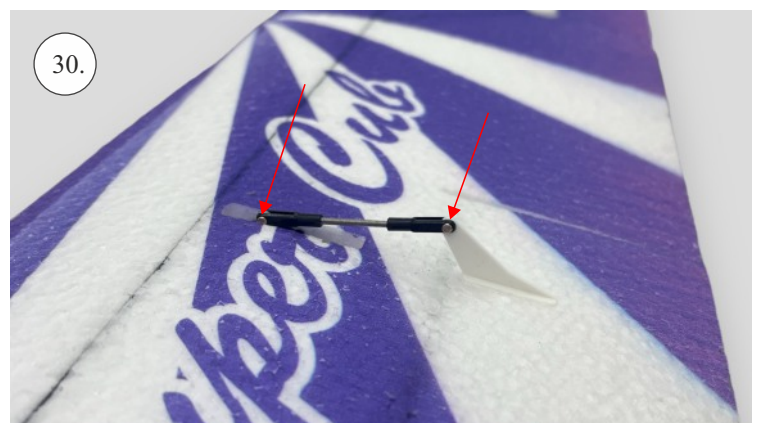
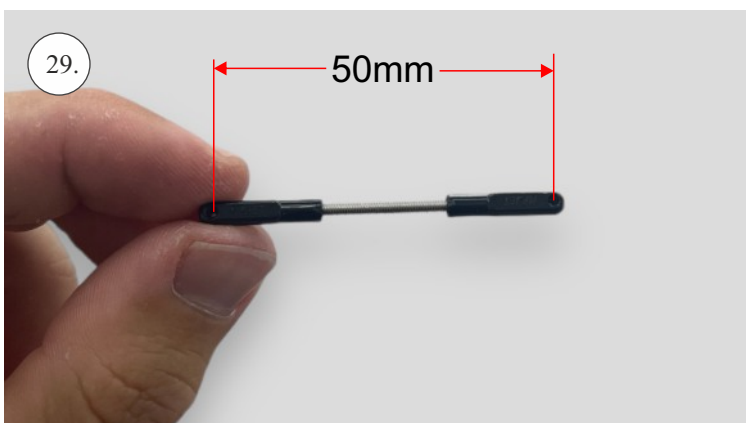
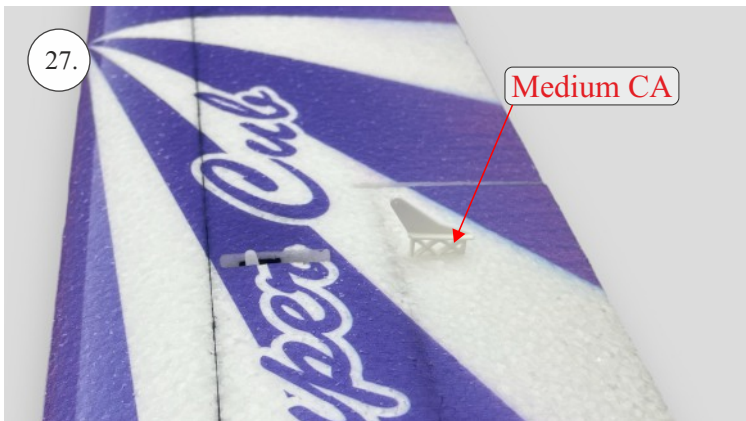
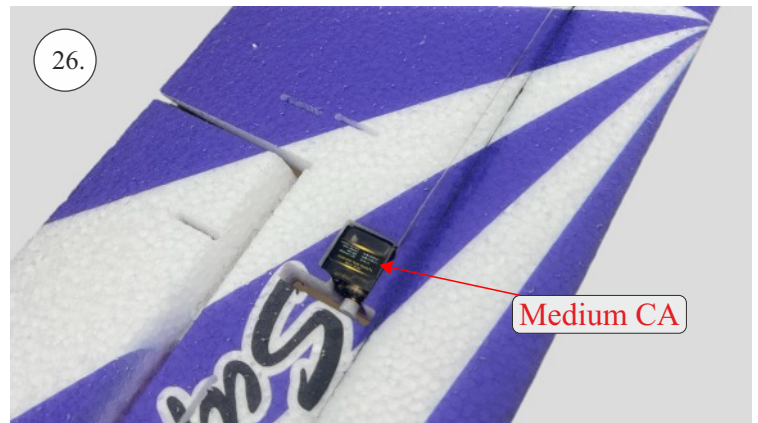
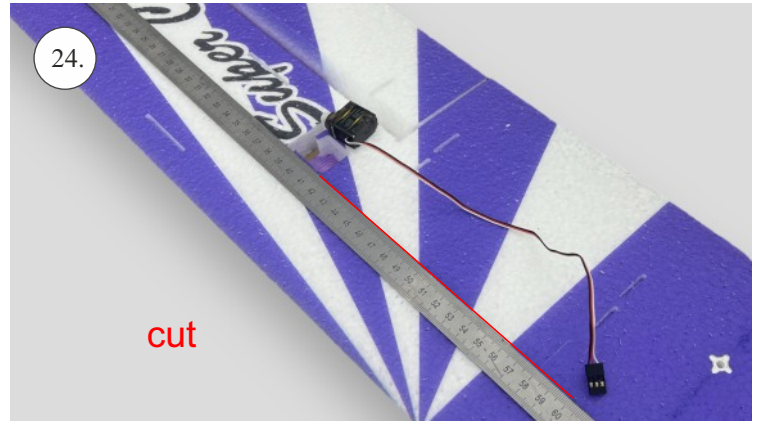
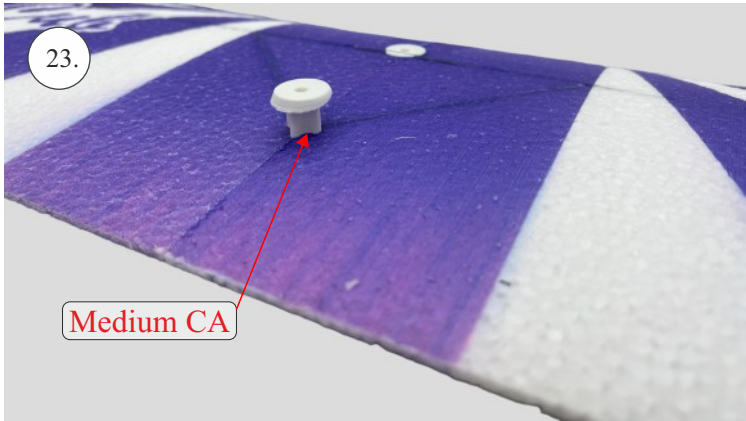
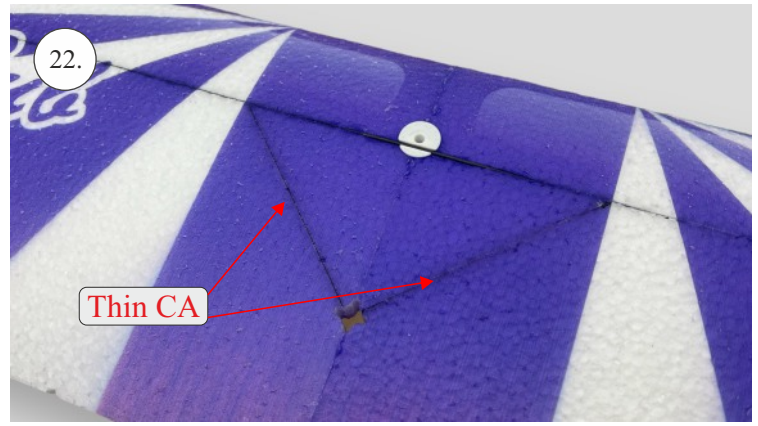
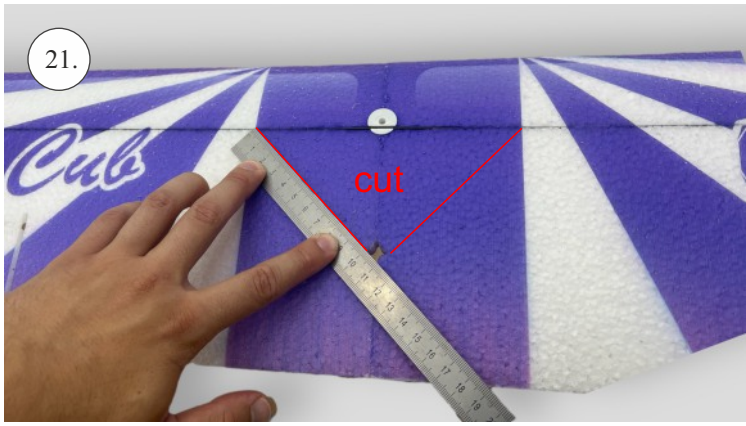

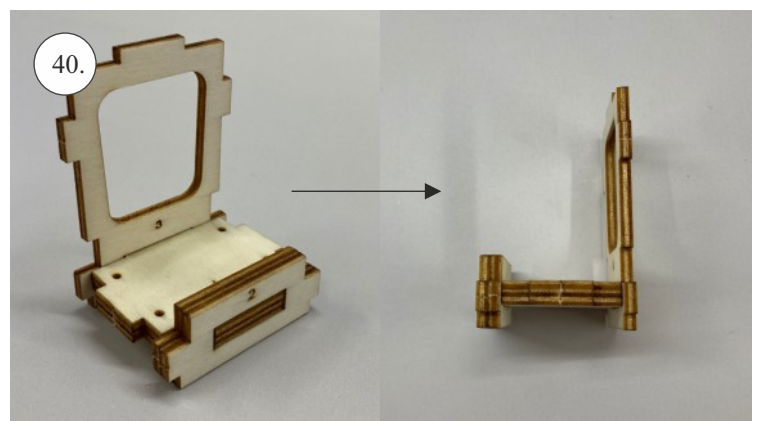
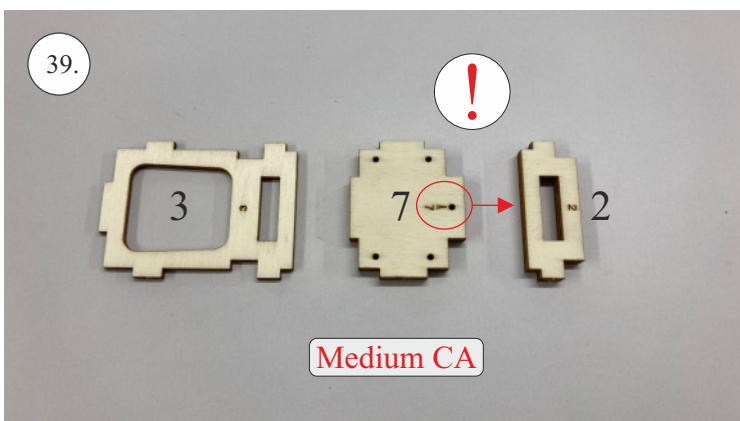
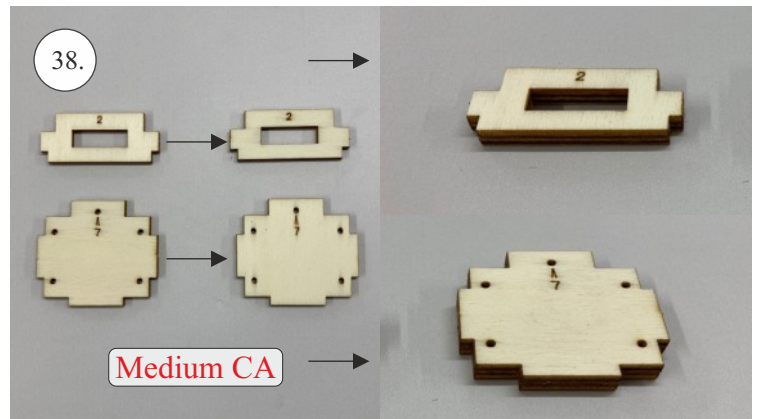
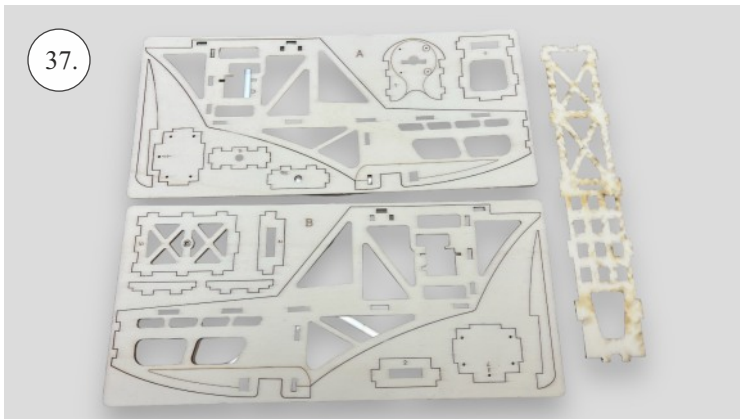
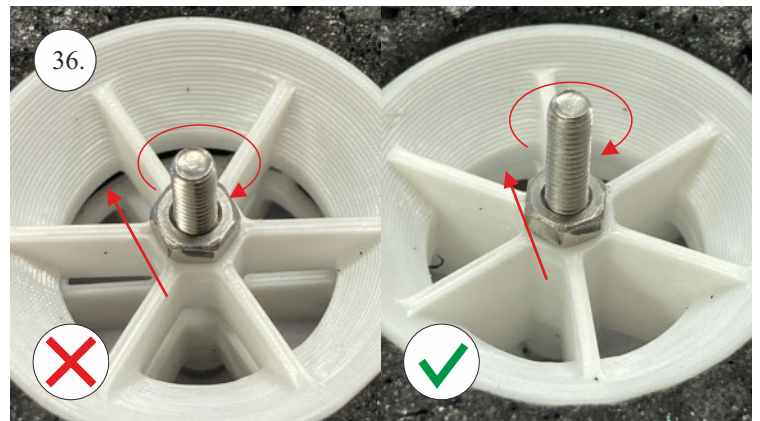
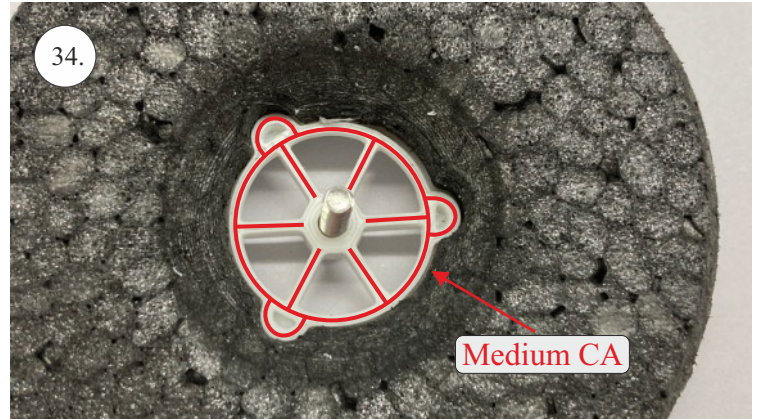
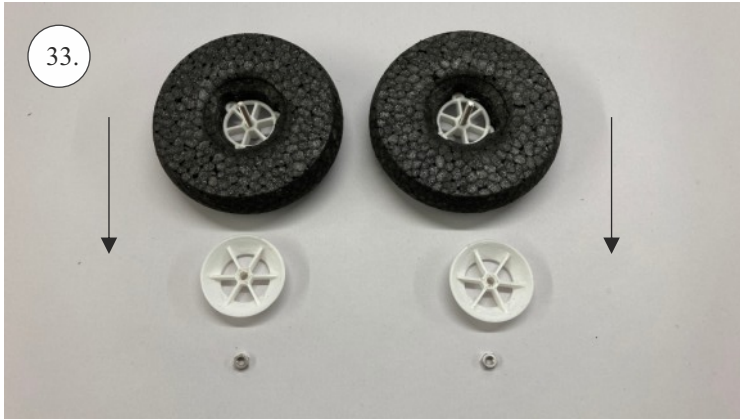

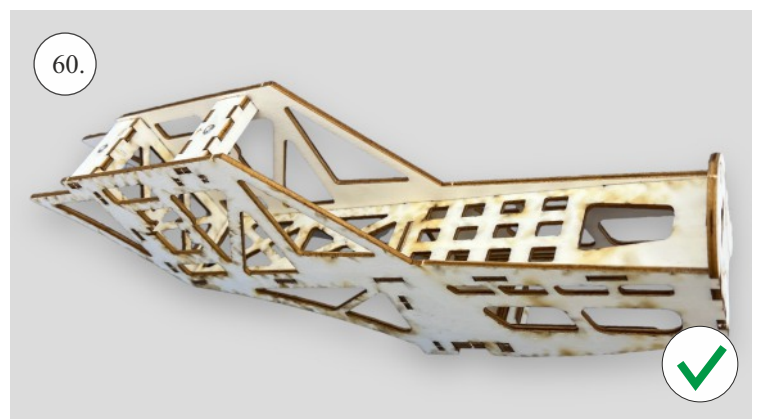
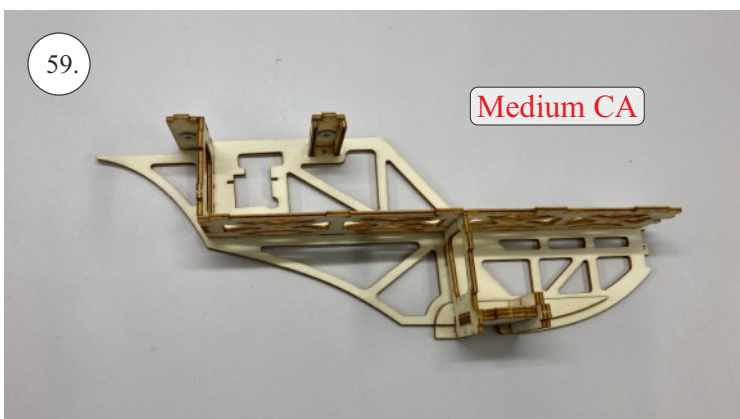
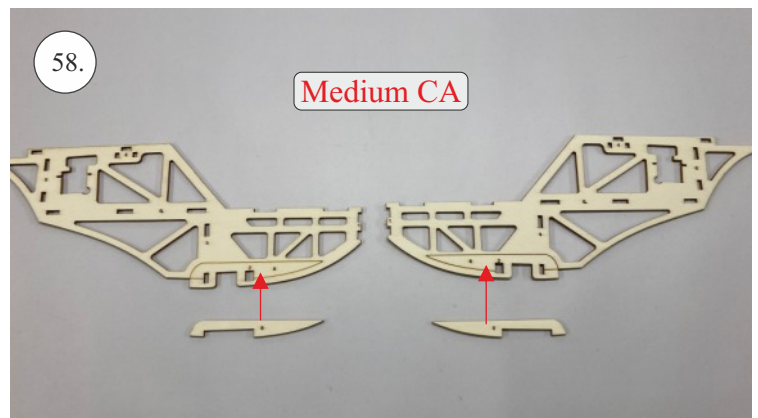
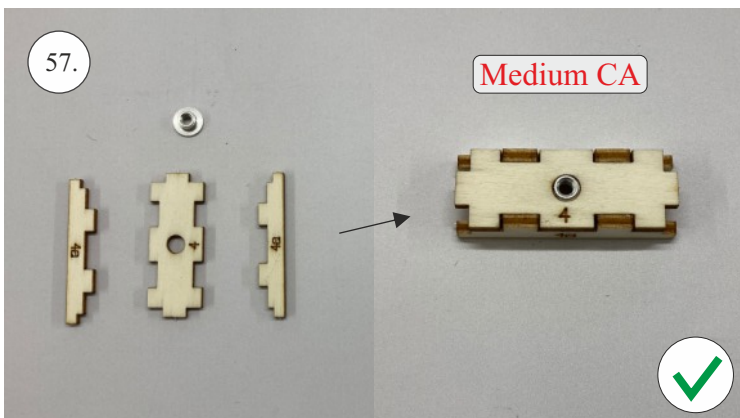
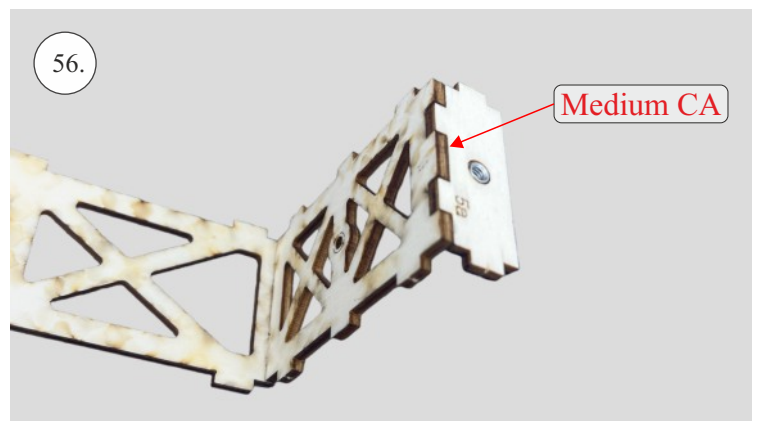
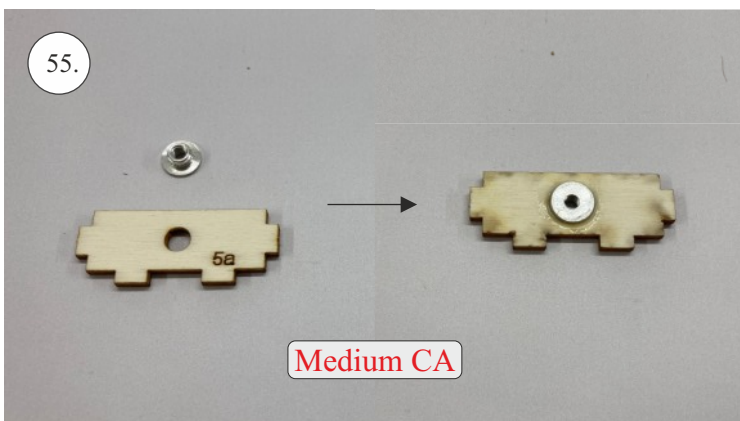
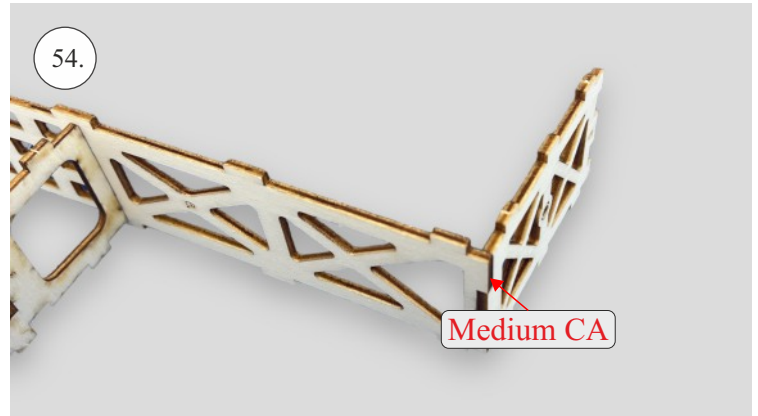
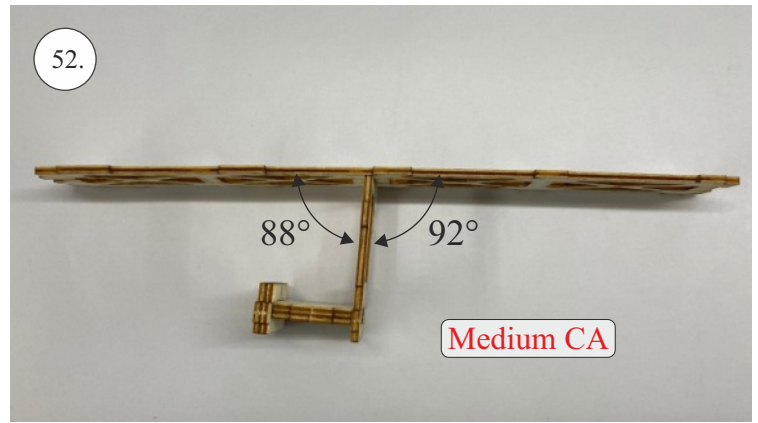
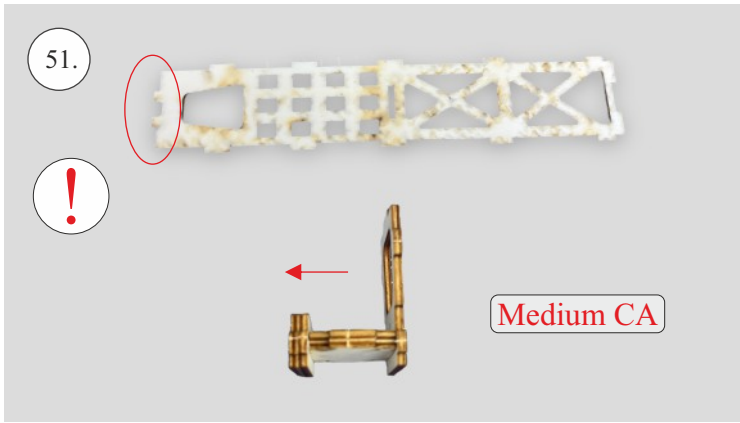

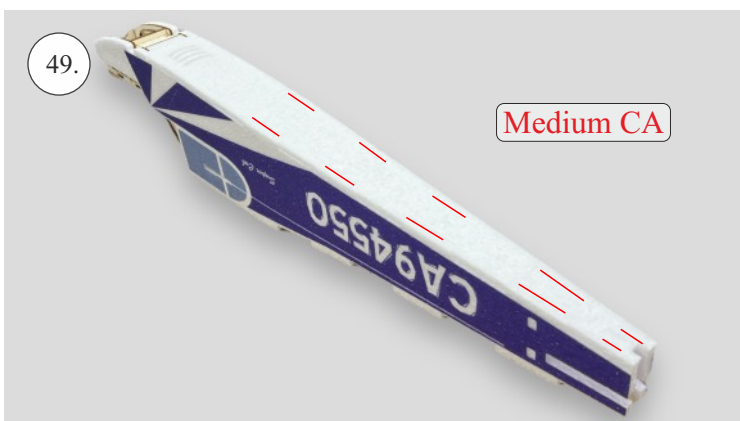
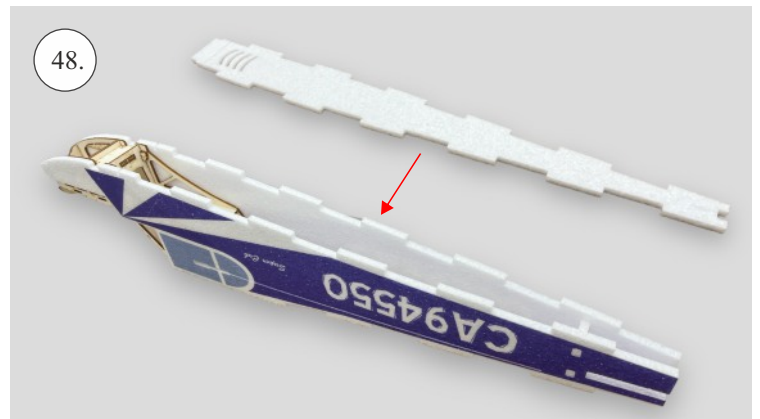
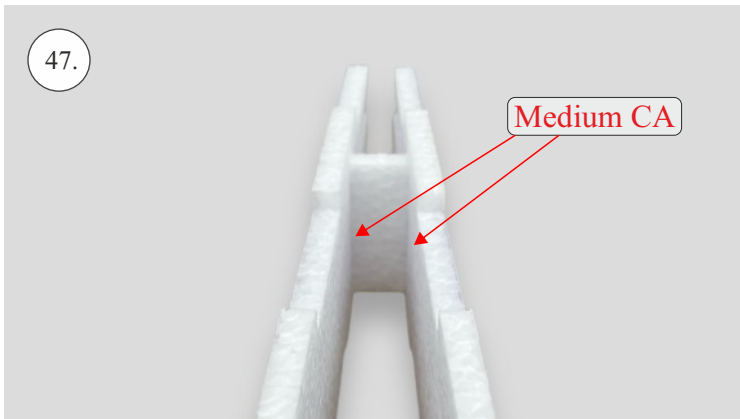
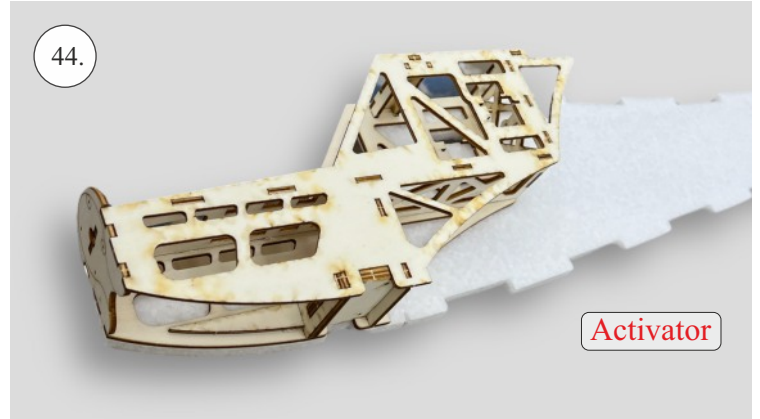
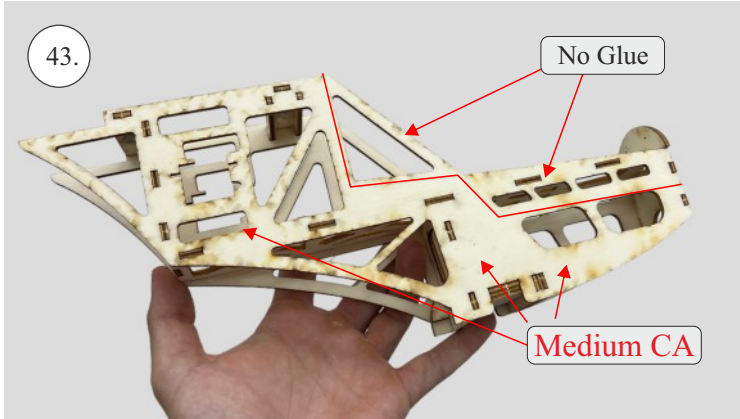
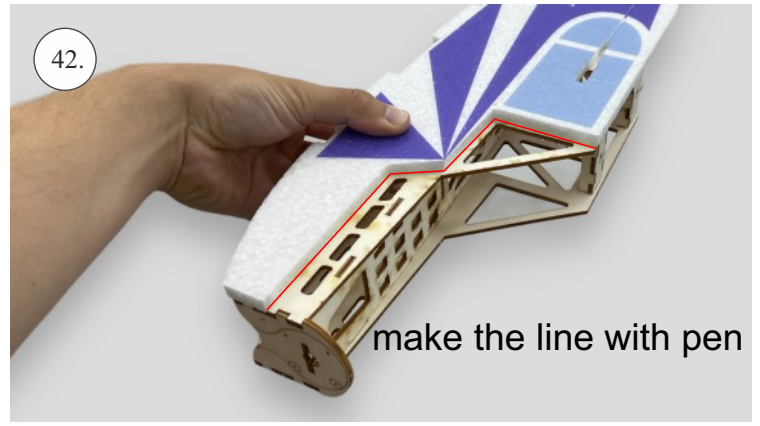
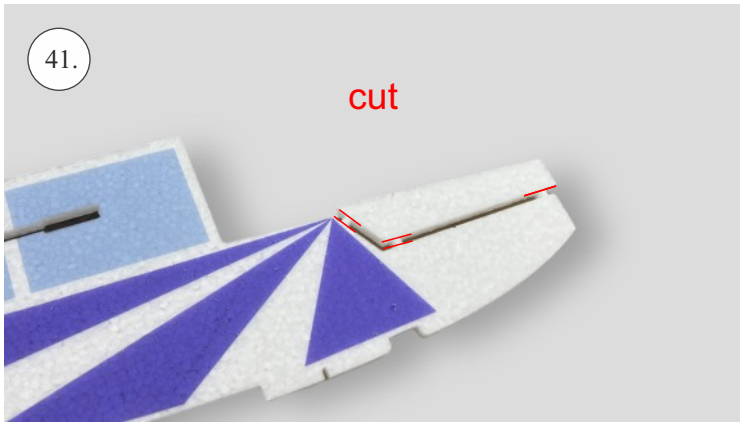

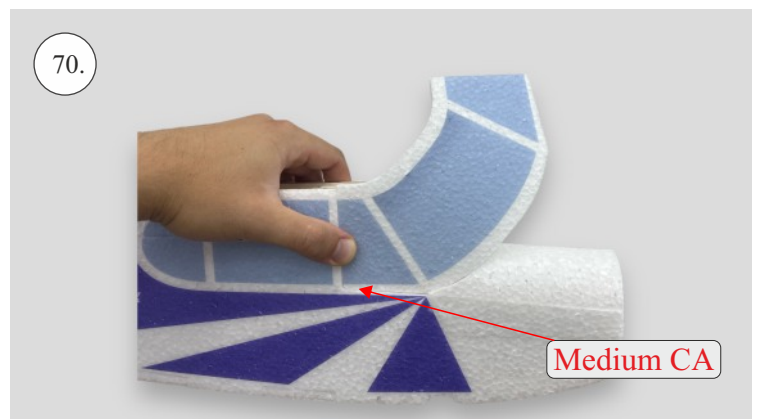
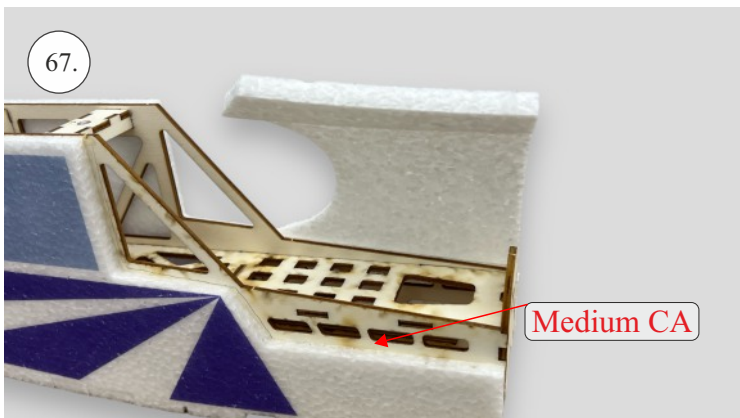
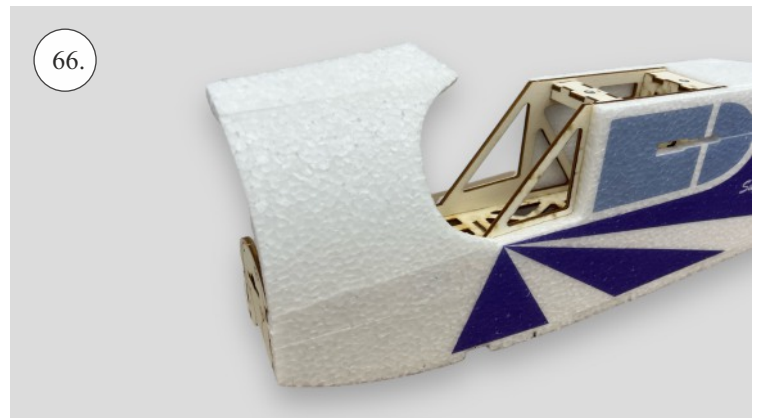
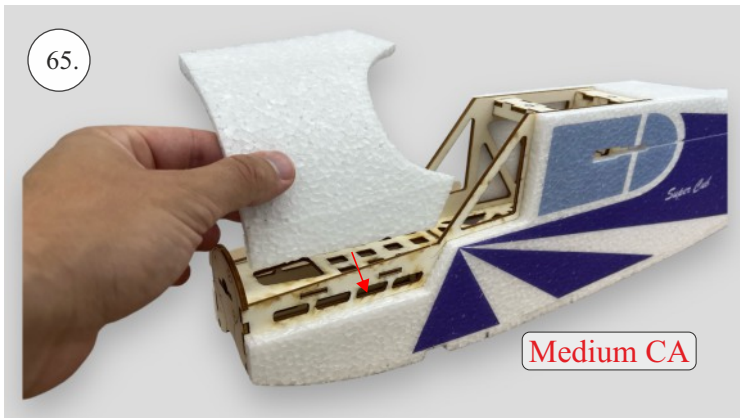
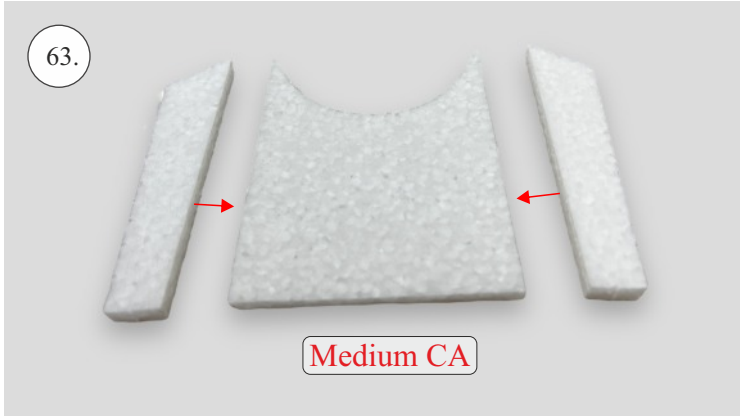

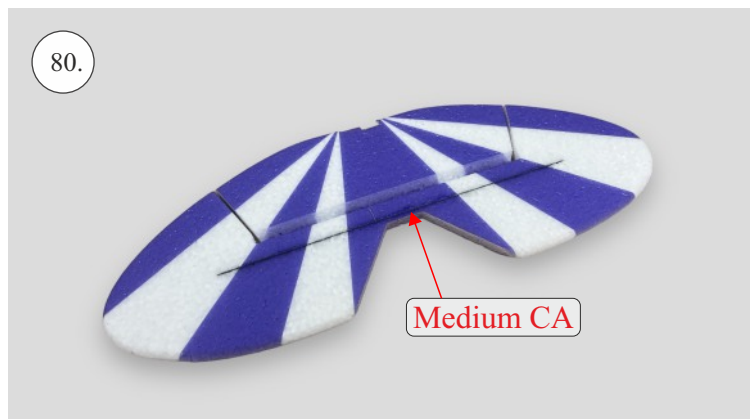
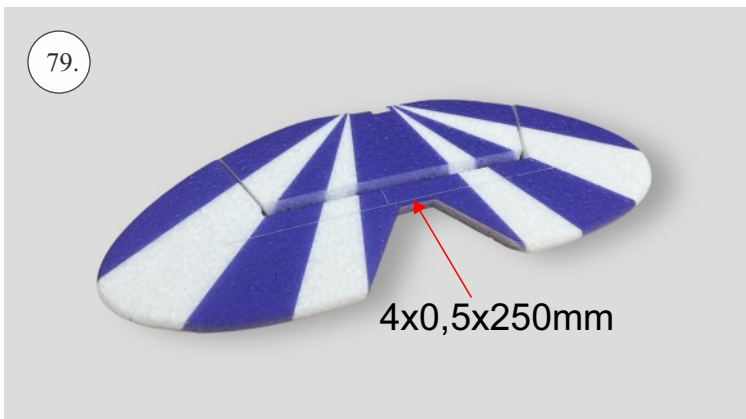
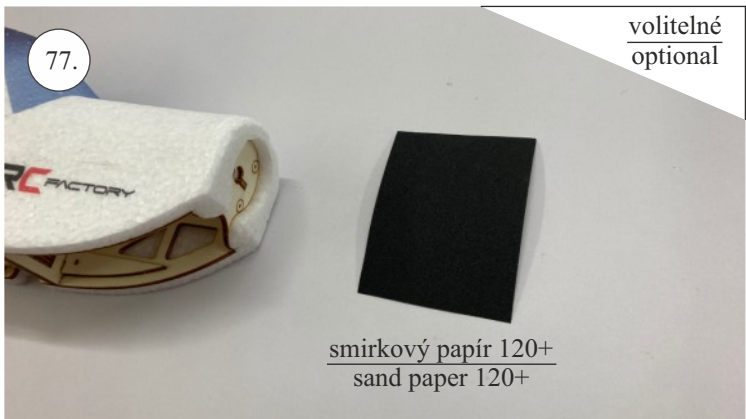
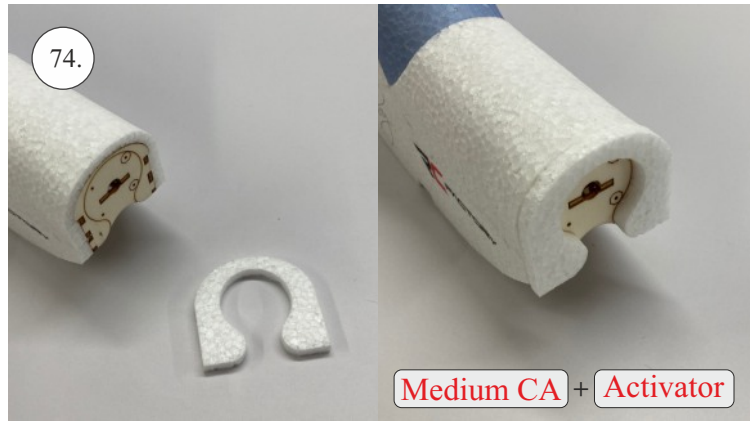
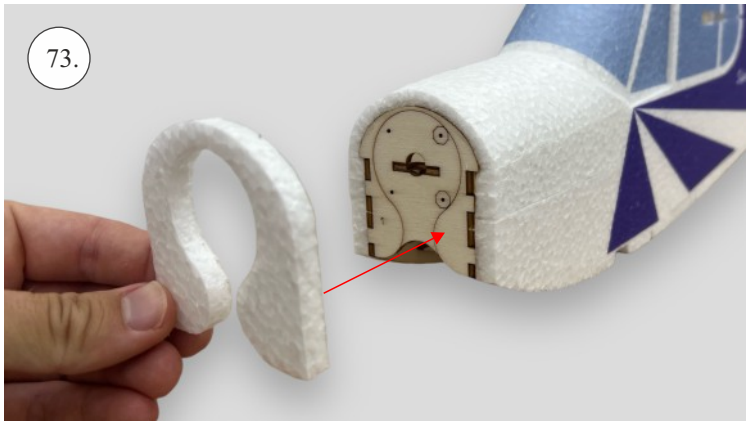
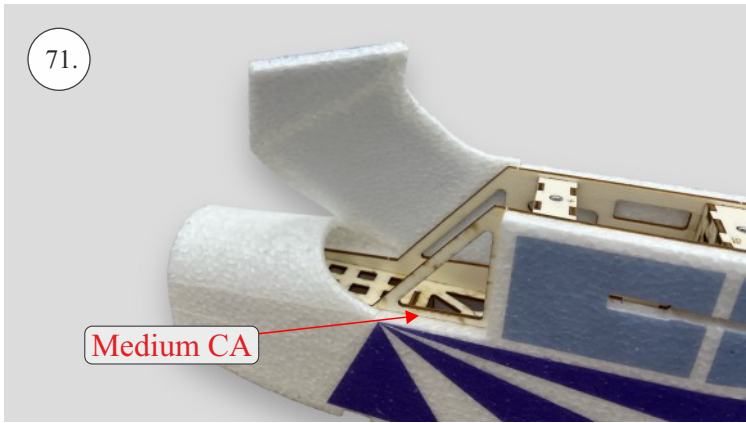

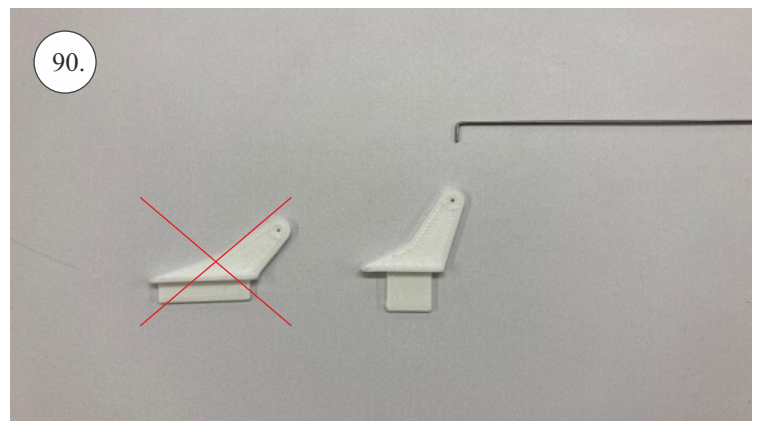
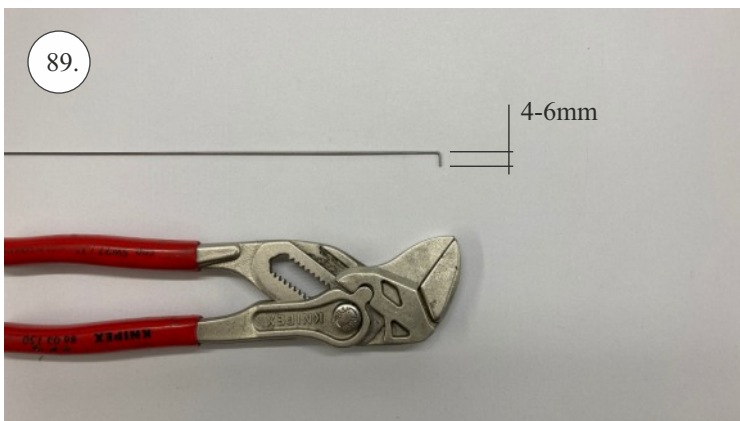
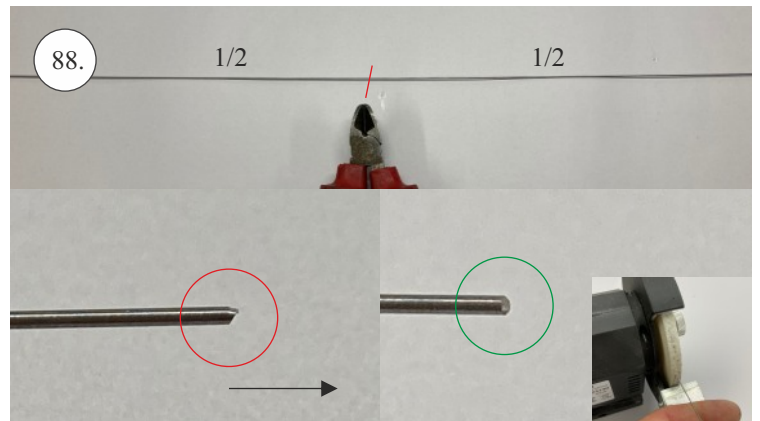
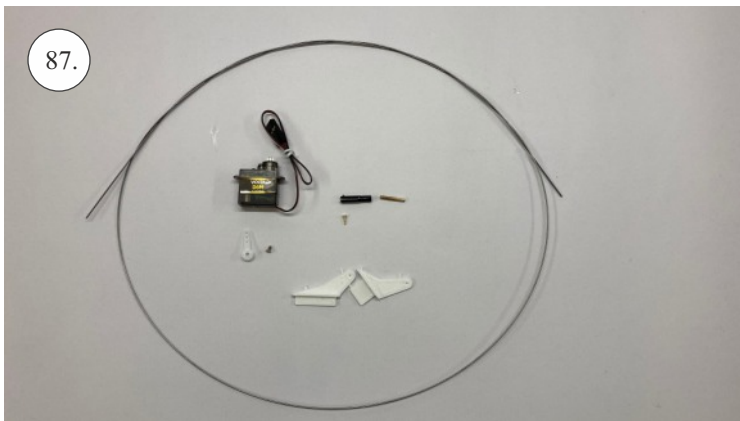
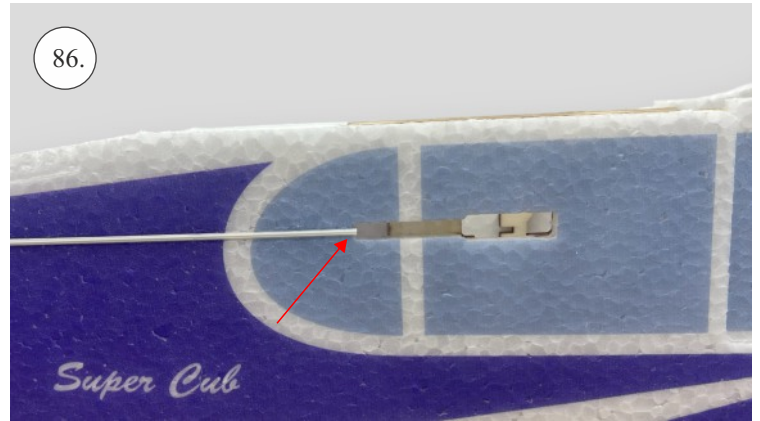
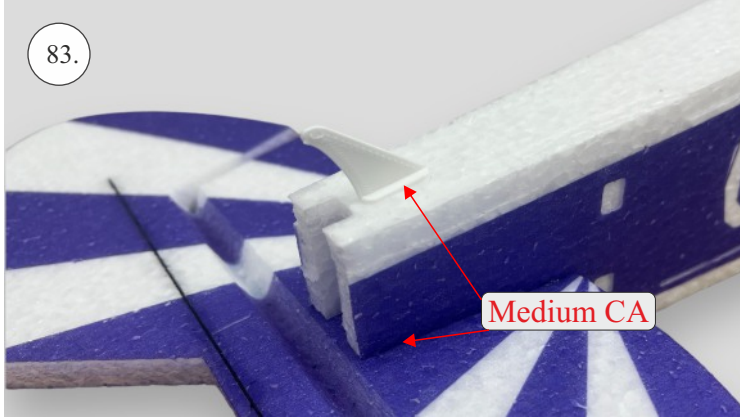
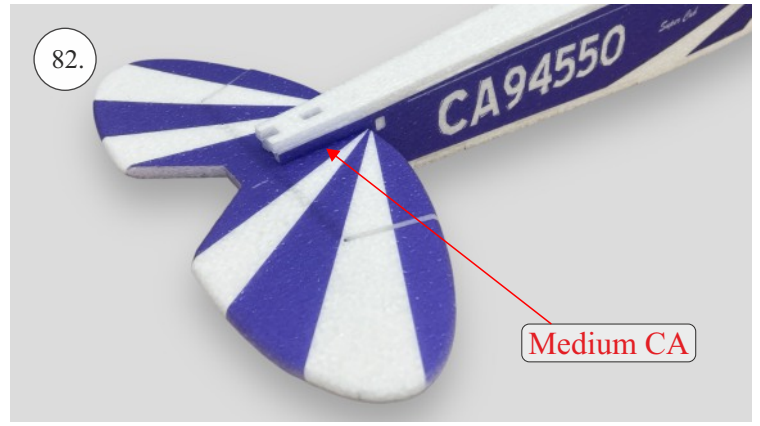
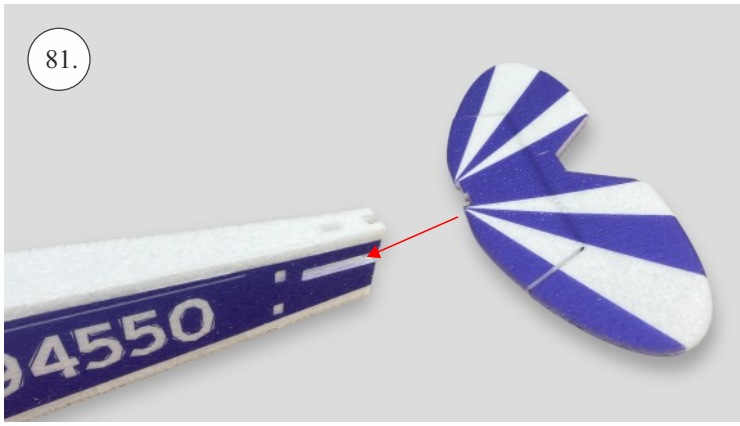

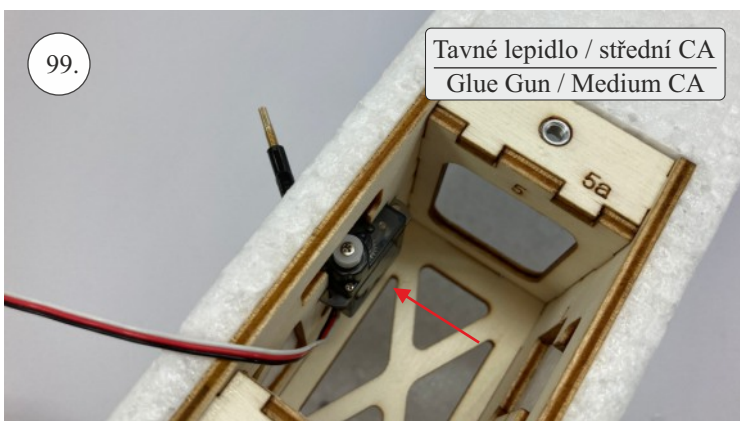
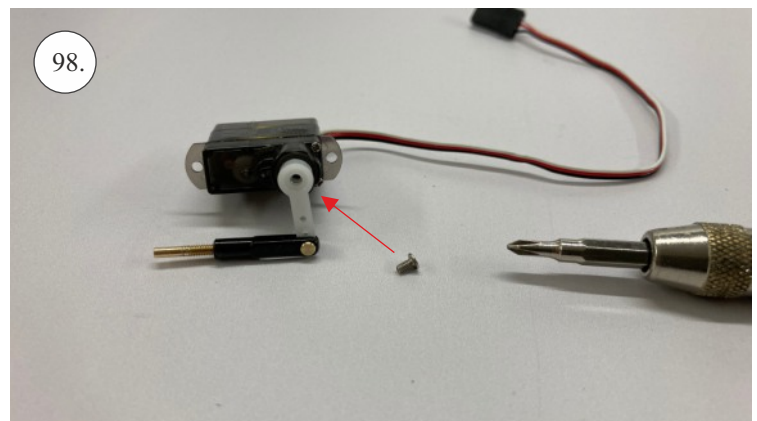
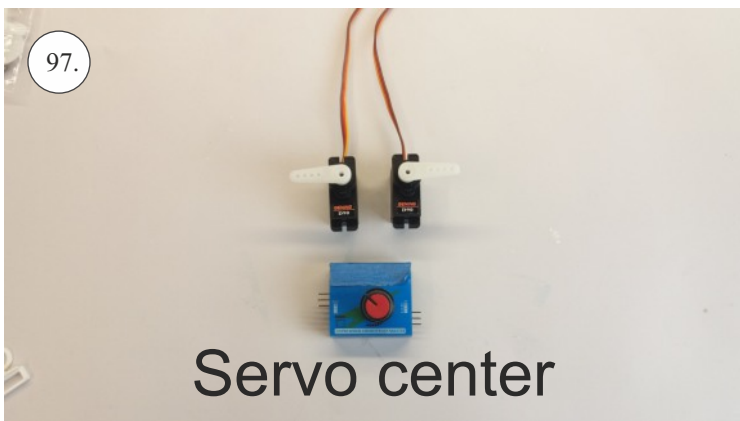
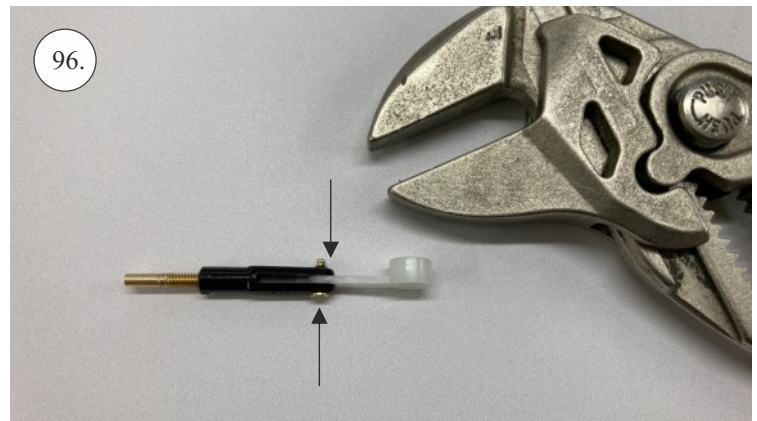
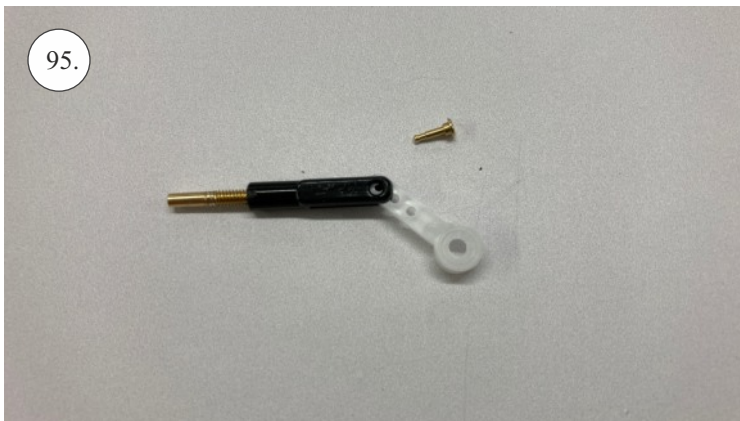
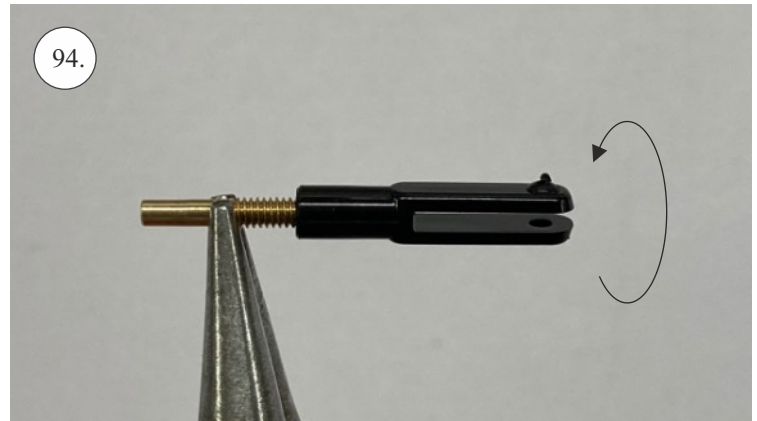
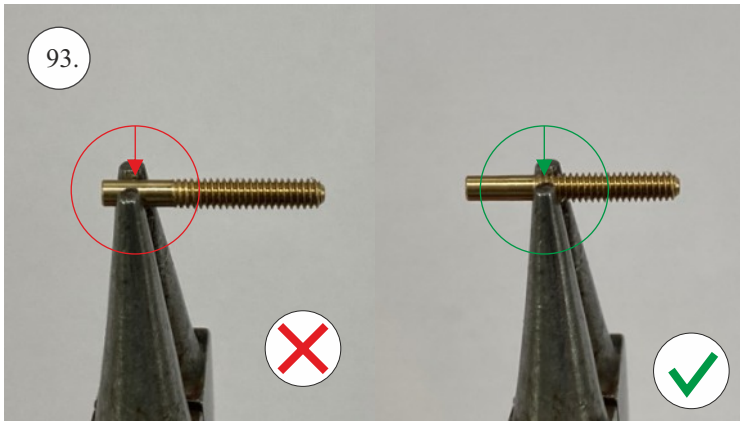
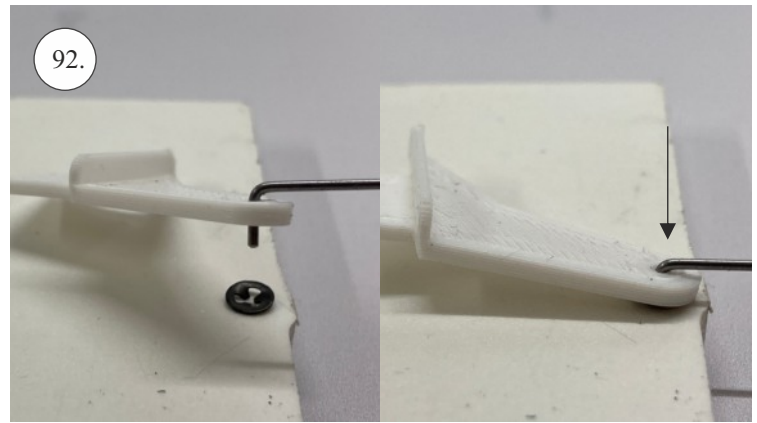
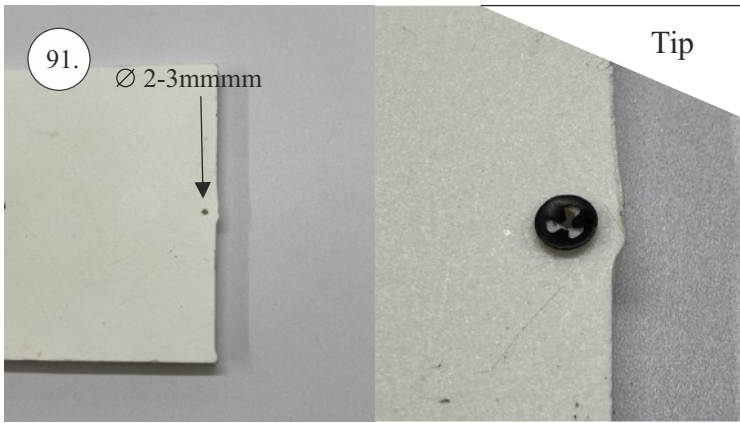

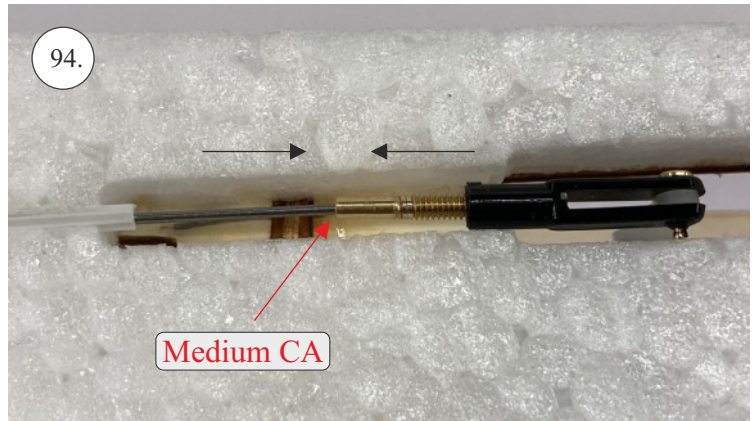
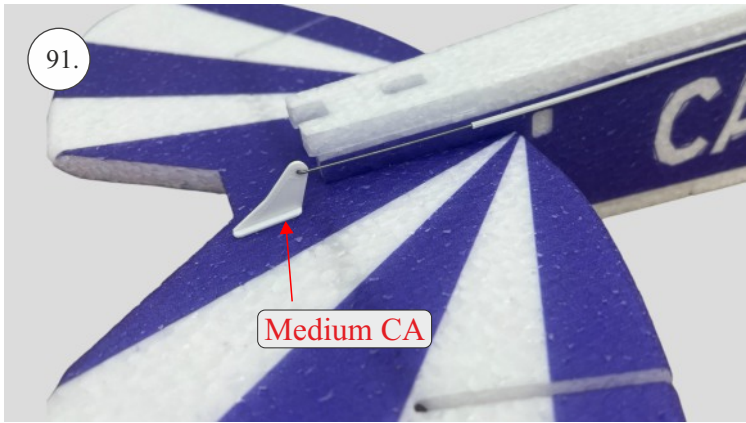

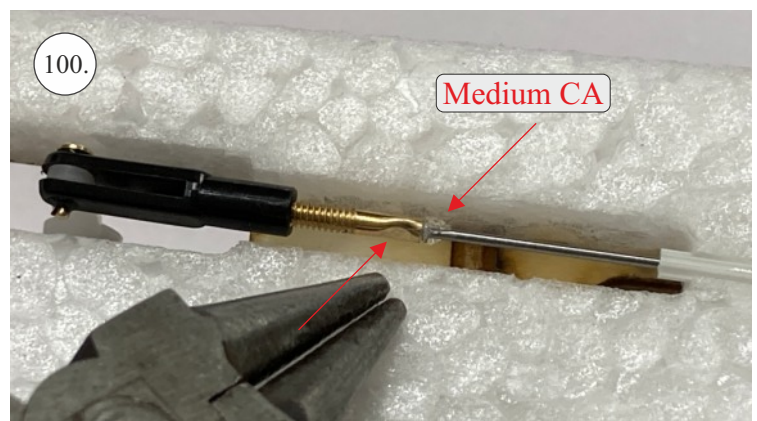
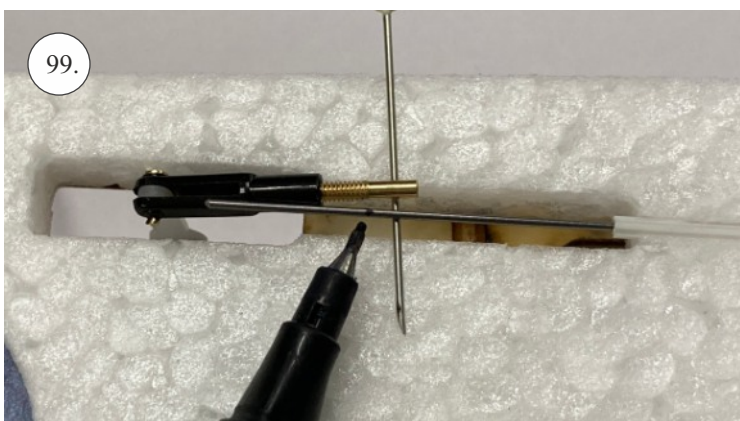
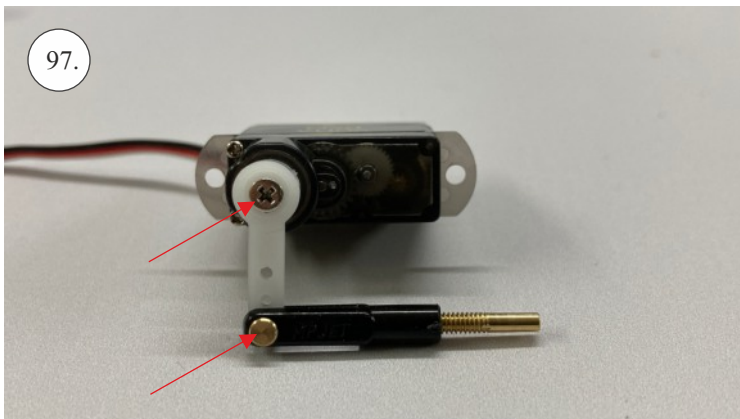
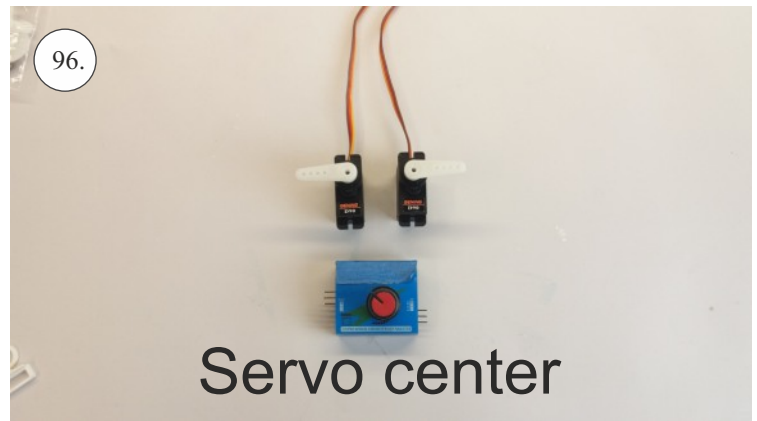
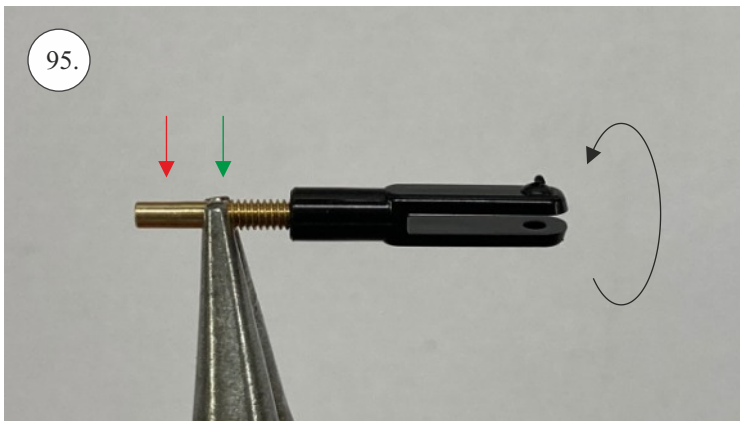
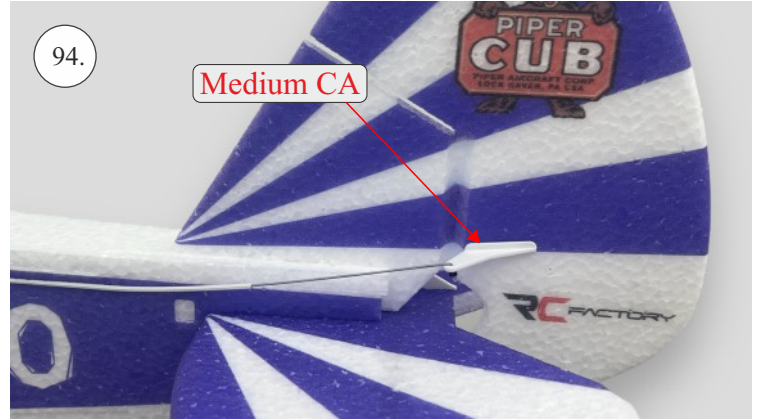
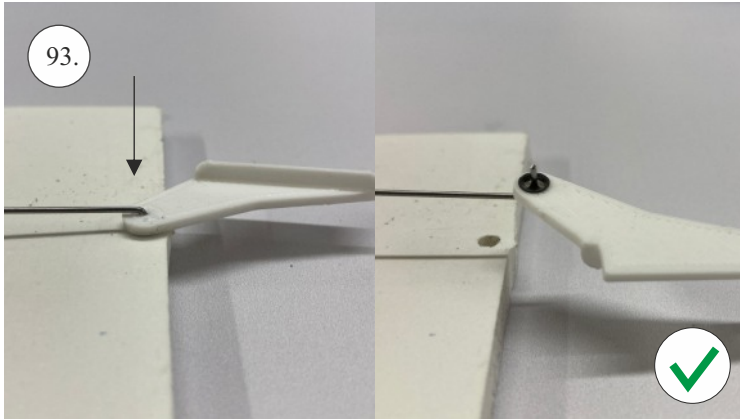
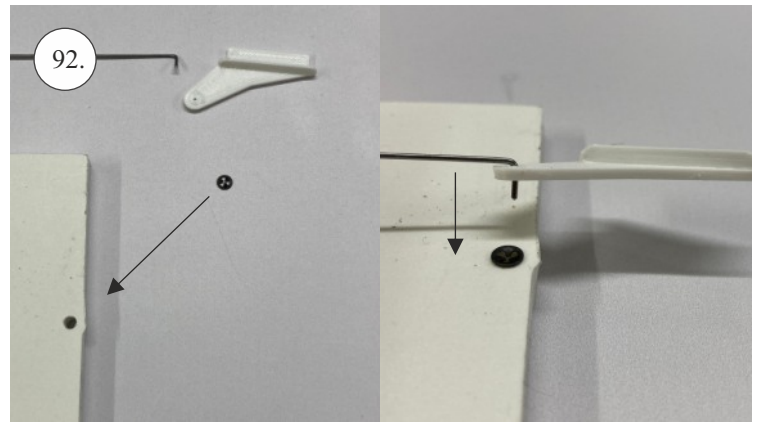
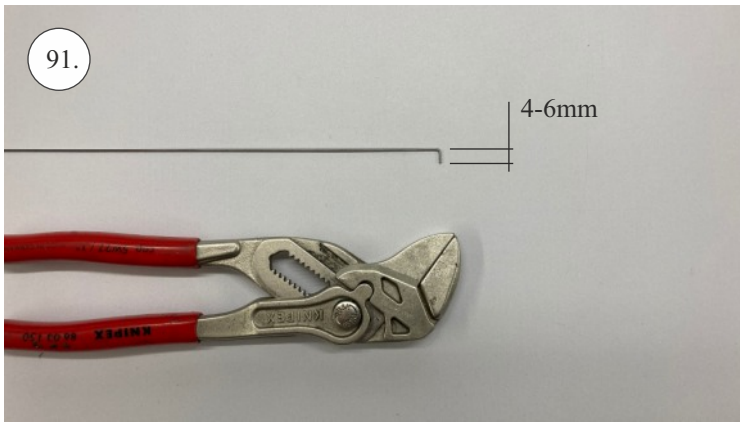

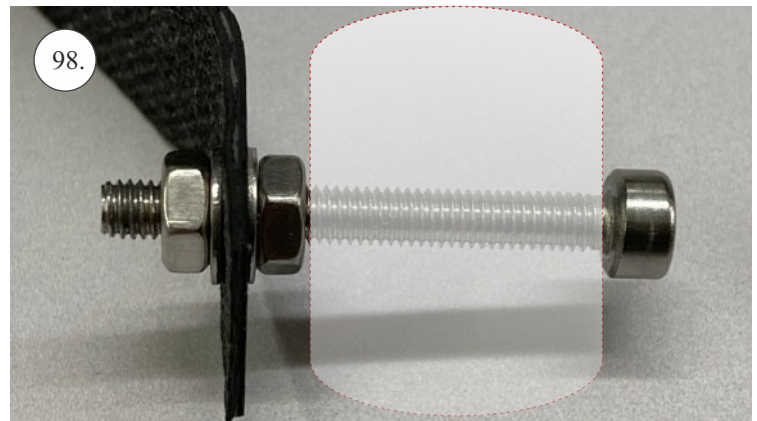
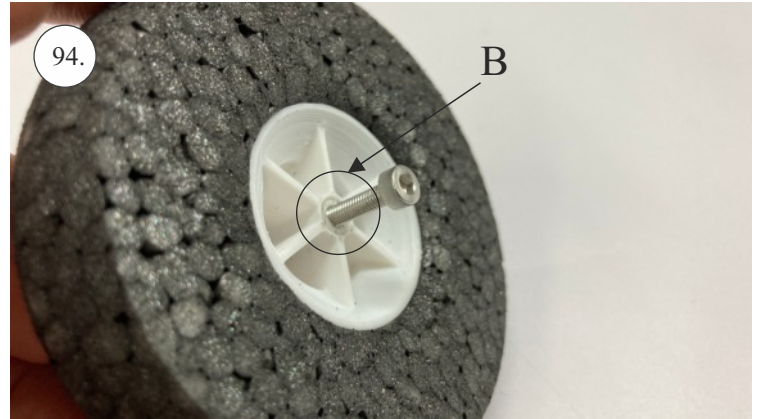
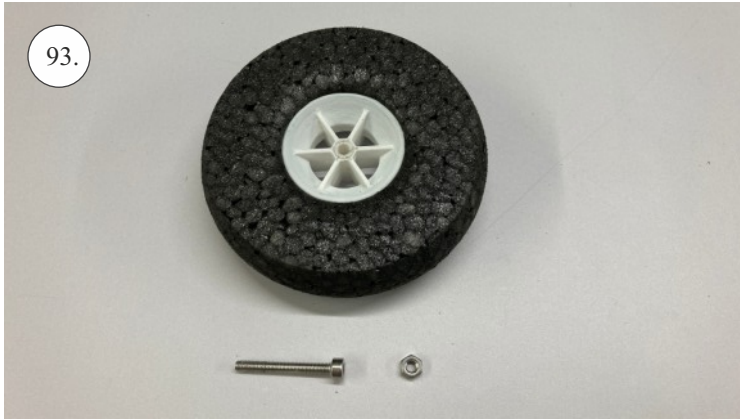
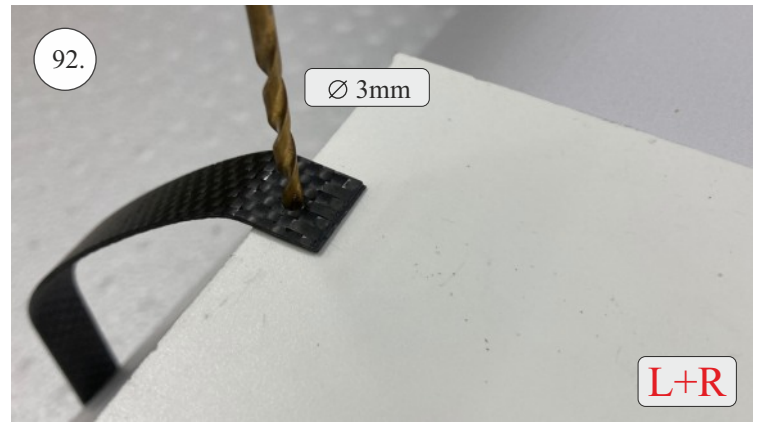

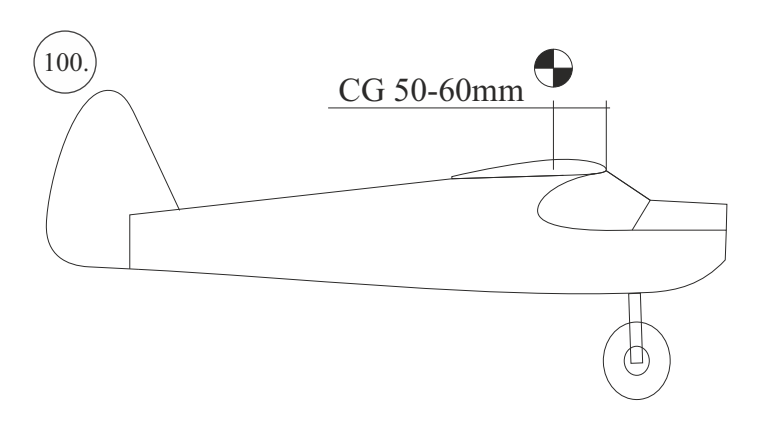
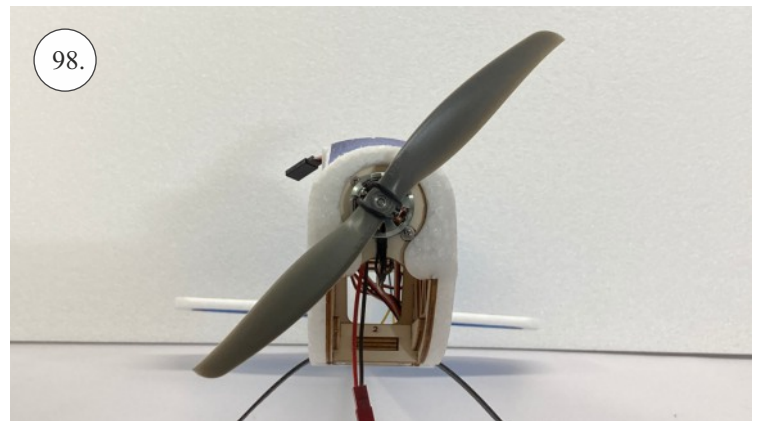
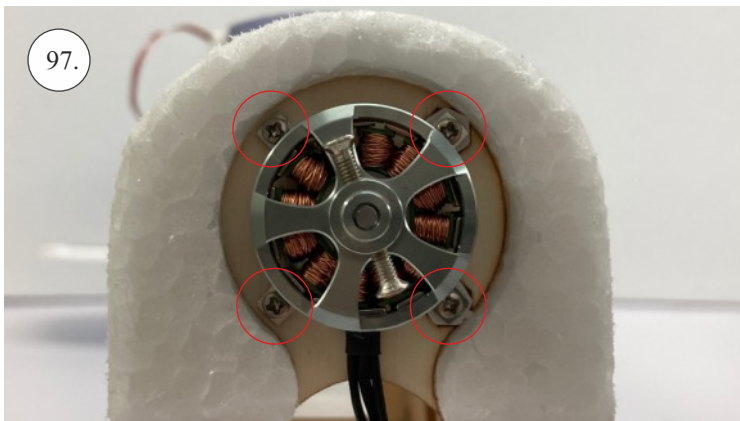
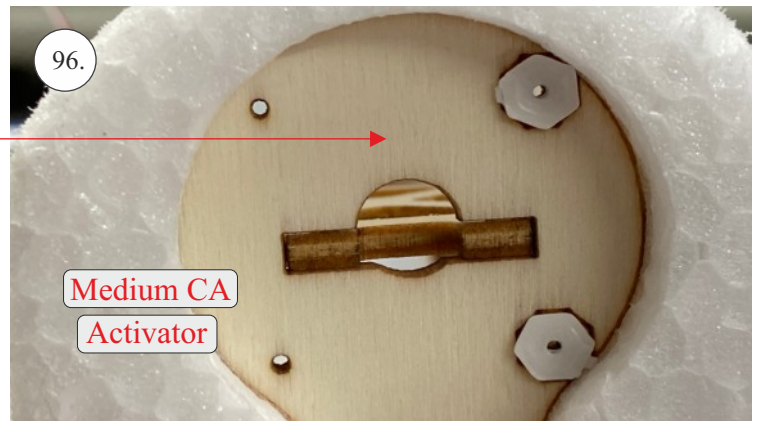
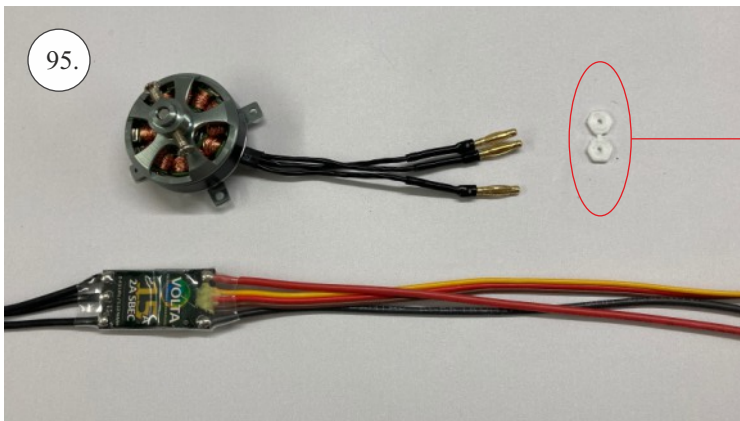
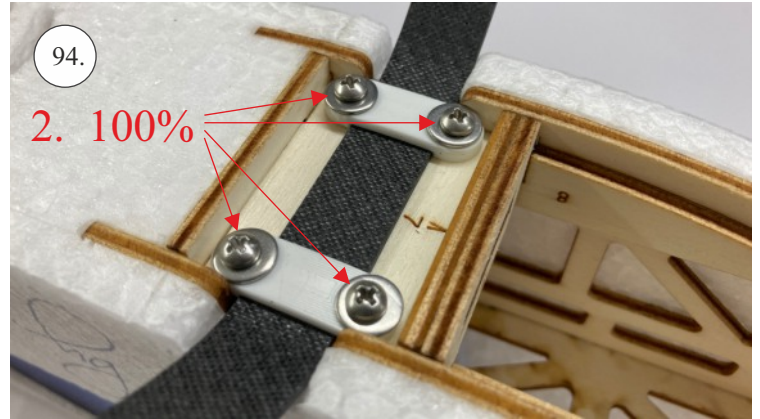
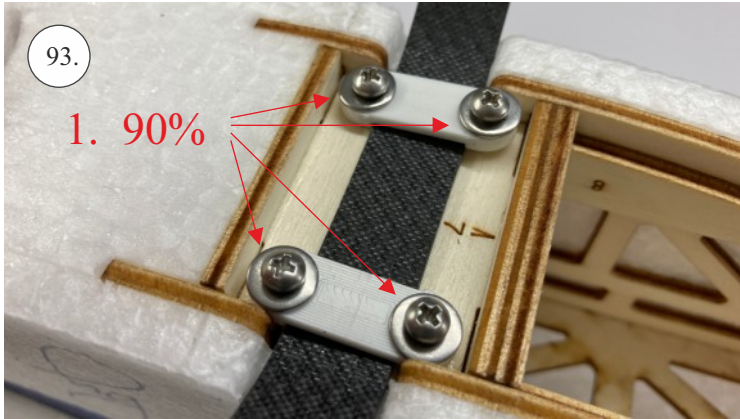
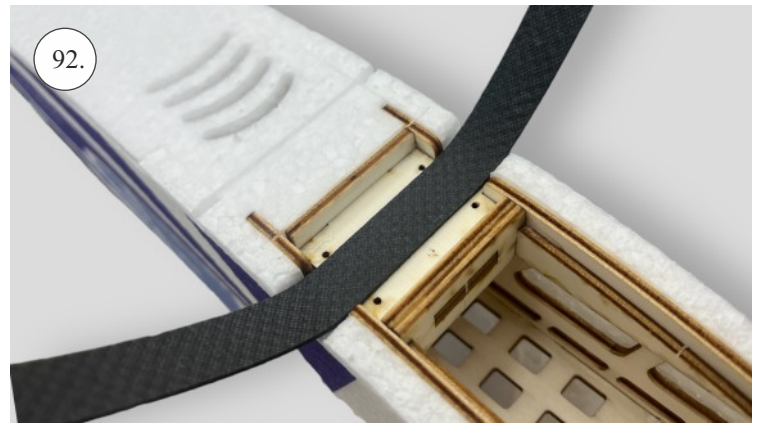
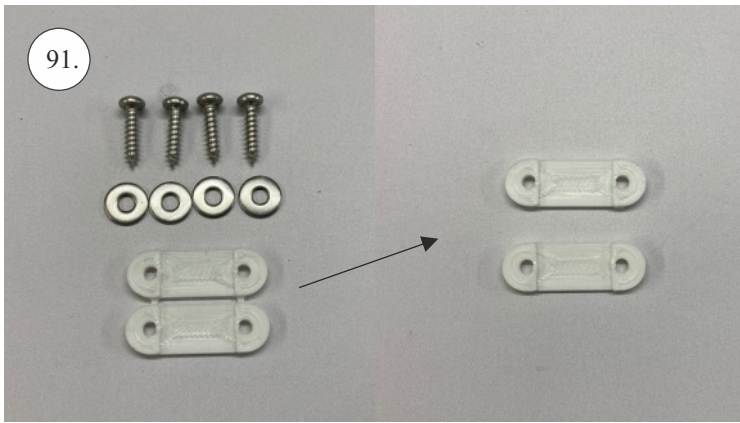

Tuning kits on www.rc-factory.eu



You can upgrade your Piper with flaps and floats!



We wish you many happy flying hours with your Piper SC!

RC Factory team